

AVX
A KYOCERA GROUP COMPANY



AVX
Surface Mount
Ceramic Capacitor Products

PASSIVES

Capacitors

- Multilayer Ceramic
- Tantalum
- Microwave
- Glass
- Film
- Power Film
- Power Ceramic
- Ceramic Disc
- Trimmer
- BestCap™

Resistors

- Chips
- Arrays
- Potentiometers

Timing Devices

- Resonators
- Oscillators
- Crystals

Filters

- EMI
- Bulk
- SAW
- Dielectric

Thin Film

- Inductors
- Fuses
- Capacitors
- Couplers
- Baluns
- Filters

Integrated Passive Components

- Low Inductance Chip Arrays
- “Z” Chips
- Capacitor Arrays
- Dual Resonance Chips
- Custom IPCs

Voltage Suppressors, Varistors and Thermistors

Acoustical Piezos

Ferrites

CONNECTORS

2mm Hard-Metric for CompactPCI®

Automotive Connectors

Board to Board Connectors –
SMT and Through-Hole

Card Edge

Compression

Custom Designed Connectors

Customized Backpanel, Racking and
Harnessing Services

DIN 41612 Connectors

FFC/FPC Connectors

Insulation Displacement Connectors

I/O Connectors

Memory Card Connectors
CF, PCMCIA, SD, MMC

MOBO™, I/O, Board to Board and
Battery Connectors

Press-fit Connectors

Varicon®

Wire to Board, Crimp or IDC

**For more information please visit
our website at**

<http://www.avxcorp.com>

Ceramic Chip Capacitors



Table of Contents

How to Order - AVX Part Number Explanation	2-3
C0G (NP0) Dielectric	
General Specifications	4
Specifications and Test Methods	5
Capacitance Range	6-7
U Dielectric	
General Information	8
Capacitance Range	9-10
X7R Dielectric	
General Specifications	11
Specifications and Test Methods	12
Capacitance Range	13-14
X5R Dielectric	
General Specifications	15
Specifications and Test Methods	16
Capacitance Range	17
Y5V Dielectric	
General Specifications	18
Specifications and Test Methods	19
Capacitance Range	20
Automotive MLCC	
General Specifications	21
NP0/X7R Dielectric	22
NP0 Capacitance Range	23
MBE/X7R Capacitance Range	24
Capacitor Array	
General Description	26-29
Part and Pad Layout Dimensions	30
Low Inductance Capacitors	
Introduction	31-32
LICC (Low Inductance Chip Capacitors)	33-34
IDC (InterDigitated Capacitors)	35-36
LICA (Low Inductance Decoupling Capacitor Arrays)	37-38
High Voltage Chips for 500V to 5000V Applications	39-40
MIL-PRF-55681/Chips	
Part Number Example (CDR01 thru CDR06)	41
Military Part Number Identification (CDR01 thru CDR06)	42
Part Number Example (CDR31 thru CDR35)	43
Military Part Number Identification (CDR31)	44
Military Part Number Identification (CDR32)	45
Military Part Number Identification (CDR33/34/35)	46
Packaging of Chip Components	47
Embossed Carrier Configuration - 8 & 12mm Tape	48
Paper Carrier Configuration - 8 & 12mm Tape	49
Bulk Case Packaging	50
Basic Capacitor Formulas	51
General Description	52-56
Surface Mounting Guide	57-60



How to Order

Part Number Explanation

Commercial Surface Mount Chips

EXAMPLE: 08055A101JAT2A

0805	5	A	101	J*	A	T	2	A
Size (L" x W")	Voltage	Dielectric	Capacitance	Tolerance	Failure Rate	Terminations	Packaging	Special Code
0201 0402 0603 0805 1206 1210 1812 1825 2220 2225	4 = 4V 6 = 6.3V Z = 10V Y = 16V 3 = 25V D = 35V 5 = 50V 1 = 100V 2 = 200V	A = NP0(C0G) C = X7R D = X5R G = Y5V U = U Series W = X6S Z = X7S	2 Sig. Fig + No. of Zeros Examples: 100 = 10 pF 101 = 100 pF 102 = 1000 pF 223 = 22000 pF 224 = 220000 pF 105 = 1µF 106 = 10µF 107 = 100µF For values below 10 pF, use "R" in place of Decimal point, e.g., 9.1 pF = 9R1.	B = ±.10 pF C = ±.25 pF D = ±.50 pF F = ±1% (≥ 25 pF) G = ±2% (≥ 13 pF) J = ±5% K = ±10% M = ±20% Z = +80%, -20% P = +100%, -0%	A = N/A	T = Plated Ni and Sn 7 = Gold Plated	<u>Available</u> 2 = 7" Reel 4 = 13" Reel 7 = Bulk Cass. 9 = Bulk	A = Std.
	Contact Factory for Special Voltages F = 63V 9 = 300V * = 75V X = 350V E = 150V 8 = 400V V = 250V					Contact Factory For 1 = Pd/Ag Term	Contact Factory For Multiples	
						* B, C & D tolerance for ≤10 pF values. Standard Tape and Reel material (Paper/Embossed) depends upon chip size and thickness. See individual part tables for tape material type for each capacitance value.		

High Voltage Surface Mount Chips

EXAMPLE: 1808AA271KA11A

1808	A	A	271	K	A	1	1A
AVX Style	Voltage	Temperature Coefficient	Capacitance Code	Capacitance Tolerance	Failure Rate	Termination	Packaging/Marking
1206 1210 1808 1812 1825 2220 2225 3640	7 = 500V C = 600V A = 1000V S = 1500V G = 2000V W = 2500V H = 3000V J = 4000V K = 5000V	A = C0G C = X7R	(2 significant digits + no. of zeros) Examples: 10 pF = 100 100 pF = 101 1,000 pF = 102 22,000 pF = 223 220,000 pF = 224 1 µF = 105	C0G: J = ±5% K = ±10% M = ±20% X7R: K = ±10% M = ±20% Z = +80%, -20%	A=Not Applicable	1 = Pd/Ag T = Plated Ni and Sn	1A = 7" Reel Unmarked 3A = 13" Reel Unmarked 9A = Bulk/Unmarked

Ultra Thin Surface Mount Chips

EXAMPLE: UT023C223MAT2A

UT	02	3	C	223	M	A	T	2	A
Style	Case Size	Voltage	Dielectric	Capacitance Code (In pF)	Capacitance Tolerance	Std.	Term	Packaging Code	Terminations Code (max.)
Ultrathin	01 = 0603 02 = 0805 03 = 1206	Y = 16Vdc 3 = 25Vdc 5 = 50Vdc	A = C0G C = X7R	2 Sig Digits + Number of Zeros			T = Plated Ni and Sn	2 = 7" reel	A = 0.50mm (0.020) B = 0.40mm (0.016) C = 0.35mm (0.014)

Please handle these products with due care as they are inherently more fragile than standard MLC capacitors because of their physical dimensions.

How to Order

Part Number Explanation

Capacitor Array

EXAMPLE: W2A43C103MAT2A

W	2	A	4	3	C	103	M	A	T	2A
Style	Case Size	Array	Number of Caps	Voltage	Dielectric	Capacitance Code (In pF)	Capacitance Tolerance	Failure Rate	Termination Code	Packaging & Quantity Code
	1 = 0405 2 = 0508 3 = 0612			6 = 6.3V Z = 10V Y = 16V 3 = 25V 5 = 50V 1 = 100V	A = NP0 C = X7R D = X5R	2 Sig Digits + Number of Zeros	J = ±5% K = ±10% M = ±20%		T = Plated Ni and Sn	2A = 7" Reel (4000) 4A = 13" Reel (10000) 2F = 7" Reel (1000)

Low Inductance Capacitors (LICC)

EXAMPLE: 0612ZD105MAT2A

0612	Z	D	105	M	A	T	2	A
Size	Voltage	Dielectric	Capacitance Code (In pF)	Capacitance Tolerance	Failure Rate	Terminations	Packaging Available	Thickness
0306 0508 0612	6 = 6.3V Z = 10V Y = 16V 3 = 25V	C = X7R D = X5R	2 Sig. Digits + Number of Zeros	K = ±10% M = ±20%	A = N/A	T = Plated Ni and Sn	2 = 7" Reel 4 = 13" Reel	See Page 34 for Codes

Interdigitated Capacitors (IDC)

EXAMPLE: W3L16D225MAT3A

W	3	L	1	6	D	225	M	A	T	3	A
Style	Case Size	Low Inductance	Number of Caps	Voltage	Dielectric	Capacitance Code (In pF)	Capacitance Tolerance	Failure Rate	Termination	Packaging Available	Thickness
	2 = 0508 3 = 0612	ESL = 95pH ESL = 120pH		4 = 4V 6 = 6.3V Z = 10V Y = 16V	C = X7R D = X5R	2 Sig. Digits + Number of Zeros	K = ±10% M = ±20%	A = N/A	T = Plated Ni and Sn	1 = 7" Reel 3 = 13" Reel	<u>Max. Thickness</u> mm (in.) A=0.95 (0.037) S=0.55 (0.022)

Decoupling Capacitor Arrays (LICA)

EXAMPLE: LICA3T183M3FC4AA

LICA	3	T	183	M	3	F	C	4	A	A
Style & Size	Voltage	Dielectric	Cap/Section (EIA Code)	Capacitance Tolerance	Height Code	Termination	Reel Packaging	# of Caps/Part	Inspection Code	Code Face
	5V = 9 25V = 3 50V = 5	D = X5R T = T55T S = High K T55T		M = ±20% P = GMV	6 = 0.500mm 3 = 0.650mm 1 = 0.875mm 5 = 1.100mm 7 = 1.600mm	F = C4 Solder Balls- 97Pb/3Sn P = Cr-Cu-Au N = Cr-Ni-Au X = None	M = 7" Reel R = 13" Reel 6 = 2"x2" Waffle Pack 8 = 2"x2" Black Waffle Pack 7 = 2"x2" Waffle Pack w/ termination facing up A = 2"x2" Black Waffle Pack w/ termination facing up C = 4"x4" Waffle Pack w/ clear lid	1 = one 2 = two 4 = four	A = Standard B = Established Reliability Testing	A = Bar B = No Bar C = Dot, S55S Dielectrics

C0G (NP0) Dielectric



General Specifications



C0G (NP0) is the most popular formulation of the “temperature-compensating,” EIA Class I ceramic materials. Modern C0G (NP0) formulations contain neodymium, samarium and other rare earth oxides.

C0G (NP0) ceramics offer one of the most stable capacitor dielectrics available. Capacitance change with temperature is $0 \pm 30 \text{ ppm}/^\circ\text{C}$ which is less than $\pm 0.3\% \Delta C$ from -55°C to $+125^\circ\text{C}$. Capacitance drift or hysteresis for C0G (NP0) ceramics is negligible at less than $\pm 0.05\%$ versus up to $\pm 2\%$ for films. Typical capacitance change with life is less than $\pm 0.1\%$ for C0G (NP0), one-fifth that shown by most other dielectrics. C0G (NP0) formulations show no aging characteristics.

The C0G (NP0) formulation usually has a “Q” in excess of 1000 and shows little capacitance or “Q” changes with frequency. Their dielectric absorption is typically less than 0.6% which is similar to mica and most films.

PART NUMBER (see page 2 for complete part number explanation)

0805

Size
(L" x W")

5

Voltage
6.3V = 6
10V = Z
16V = Y
25V = 3
50V = 5
100V = 1
200V = 2

A

Dielectric
C0G (NP0) = A

101

Capacitance Code (In pF)
2 Sig. Digits + Number of Zeros

J

Capacitance Tolerance
B = $\pm 10 \text{ pF}$ ($< 10 \text{ pF}$)
C = $\pm 25 \text{ pF}$ ($< 10 \text{ pF}$)
D = $\pm 50 \text{ pF}$ ($< 10 \text{ pF}$)
F = $\pm 1\%$ ($\geq 25 \text{ pF}$)
G = $\pm 2\%$ ($\geq 13 \text{ pF}$)
J = $\pm 5\%$
K = $\pm 10\%$

A

Failure Rate
A = Not Applicable

T

Terminations
T = Plated Ni and Sn
7 = Gold Plated

2

Packaging
2 = 7" Reel
4 = 13" Reel
7 = Bulk Cass.
9 = Bulk

A

Special Code
A = Std. Product

Contact Factory For
1 = Pd/Ag Term

Contact Factory For
Multiples

Temperature Coefficient

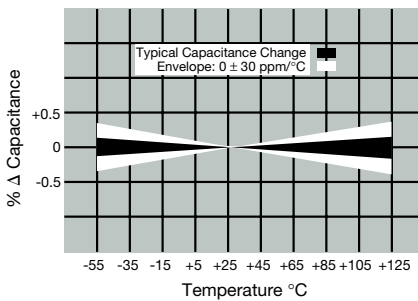

Δ Capacitance vs. Frequency

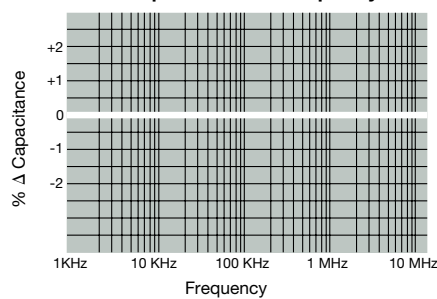

Insulation Resistance vs Temperature

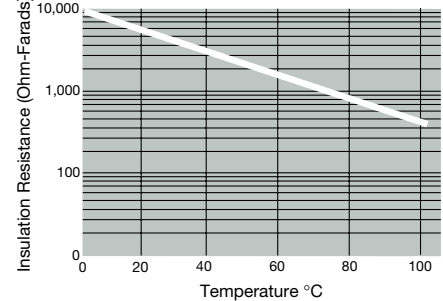

Variation of Impedance with Cap Value
Impedance vs. Frequency
0805 - C0G (NP0)
10 pF vs. 100 pF vs. 1000 pF

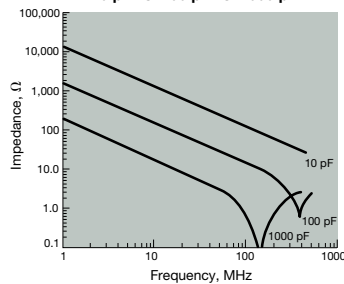

Variation of Impedance with Chip Size
Impedance vs. Frequency
1000 pF - C0G (NP0)

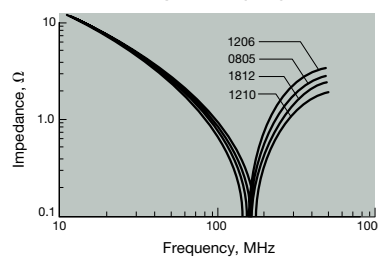

Variation of Impedance with Ceramic Formulation
Impedance vs. Frequency
1000 pF - C0G (NP0) vs X7R
0805

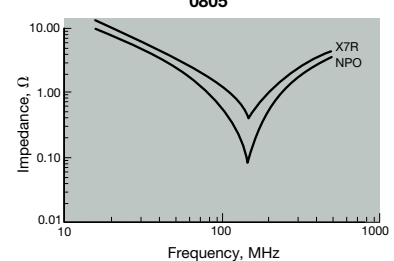

COG (NP0) Dielectric

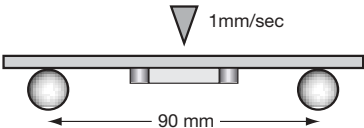

Specifications and Test Methods

Parameter/Test		NP0 Specification Limits	Measuring Conditions	
Operating Temperature Range		-55°C to +125°C	Temperature Cycle Chamber	
Capacitance		Within specified tolerance	Freq.: 1.0 MHz \pm 10% for cap \leq 1000 pF 1.0 kHz \pm 10% for cap $>$ 1000 pF Voltage: 1.0Vrms \pm .2V	
Q		<30 pF: Q \geq 400+20 x Cap Value \geq 30 pF: Q \geq 1000		
Insulation Resistance		100,000M Ω or 1000M Ω - μ F, whichever is less	Charge device with rated voltage for 60 \pm 5 secs @ room temp/humidity	
Dielectric Strength		No breakdown or visual defects	Charge device with 300% of rated voltage for 1-5 seconds, w/charge and discharge current limited to 50 mA (max)	
Resistance to Flexure Stresses	Appearance	No defects	Deflection: 2mm Test Time: 30 seconds 	
	Capacitance Variation	\pm 5% or \pm .5 pF, whichever is greater		
	Q	Meets Initial Values (As Above)		
	Insulation Resistance	\geq Initial Value x 0.3		
Solderability		\geq 95% of each terminal should be covered with fresh solder	Dip device in eutectic solder at 230 \pm 5°C for 5.0 \pm 0.5 seconds	
Resistance to Solder Heat	Appearance	No defects, <25% leaching of either end terminal	Dip device in eutectic solder at 260°C for 60 seconds. Store at room temperature for 24 \pm 2 hours before measuring electrical properties.	
	Capacitance Variation	\leq \pm 2.5% or \pm .25 pF, whichever is greater		
	Q	Meets Initial Values (As Above)		
	Insulation Resistance	Meets Initial Values (As Above)		
Thermal Shock	Dielectric Strength	Meets Initial Values (As Above)	Repeat for 5 cycles and measure after 24 hours at room temperature	
	Appearance	No visual defects	Step 1: -55°C \pm 2°	30 \pm 3 minutes
	Capacitance Variation	\leq \pm 2.5% or \pm .25 pF, whichever is greater	Step 2: Room Temp	\leq 3 minutes
	Q	Meets Initial Values (As Above)	Step 3: +125°C \pm 2°	30 \pm 3 minutes
	Insulation Resistance	Meets Initial Values (As Above)	Step 4: Room Temp	\leq 3 minutes
Load Life	Dielectric Strength	Meets Initial Values (As Above)	Charge device with twice rated voltage in test chamber set at 125°C \pm 2°C for 1000 hours (+48, -0). Remove from test chamber and stabilize at room temperature for 24 hours before measuring.	
	Appearance	No visual defects		
	Capacitance Variation	\leq \pm 3.0% or \pm .3 pF, whichever is greater		
	Q (C=Nominal Cap)	\geq 30 pF: Q \geq 350 \geq 10 pF, <30 pF: Q \geq 275 +5C/2 <10 pF: Q \geq 200 +10C		
Load Humidity	Insulation Resistance	\geq Initial Value x 0.3 (See Above)	Store in a test chamber set at 85°C \pm 2°C/ 85% \pm 5% relative humidity for 1000 hours (+48, -0) with rated voltage applied. Remove from chamber and stabilize at room temperature for 24 \pm 2 hours before measuring.	
	Dielectric Strength	Meets Initial Values (As Above)		
	Appearance	No visual defects		
	Capacitance Variation	\leq \pm 5.0% or \pm .5 pF, whichever is greater		
Load Humidity	Q	\geq 30 pF: Q \geq 350 \geq 10 pF, <30 pF: Q \geq 275 +5C/2 <10 pF: Q \geq 200 +10C		
	Insulation Resistance	\geq Initial Value x 0.3 (See Above)		
	Dielectric Strength	Meets Initial Values (As Above)		
	Capacitance Variation	\leq \pm 5.0% or \pm .5 pF, whichever is greater		

COG (NP0) Dielectric



Capacitance Range

PREFERRED SIZES ARE SHADED

SIZE		0201			0402			0603				0805					1206				
Soldering		Reflow Only			Reflow Only			Reflow/Wave				Reflow/Wave					Reflow/Wave				
Packaging		All Paper			All Paper			All Paper				Paper/Embossed					Paper/Embossed				
L) Length	MM	0.60 ± 0.03 (0.024 ± 0.001)			1.00 ± 0.10 (0.040 ± 0.004)			1.60 ± 0.15 (0.063 ± 0.006)				2.01 ± 0.20 (0.079 ± 0.008)					3.20 ± 0.20 (0.126 ± 0.008)				
	(in.)																				
W) Width	MM	0.30 ± 0.03 (0.011 ± 0.001)			0.50 ± 0.10 (0.020 ± 0.004)			0.81 ± 0.15 (0.032 ± 0.006)				1.25 ± 0.20 (0.049 ± 0.008)					1.60 ± 0.20 (0.063 ± 0.008)				
	(in.)																				
t) Terminal	MM	0.15 ± 0.05 (0.006 ± 0.002)			0.25 ± 0.15 (0.010 ± 0.006)			0.35 ± 0.15 (0.014 ± 0.006)				0.50 ± 0.25 (0.020 ± 0.010)					0.50 ± 0.25 (0.020 ± 0.010)				
	(in.)																				
WVDC		10	16	25	16	25	50	6.3	25	50	100	16	25	50	100	200	16	25	50	100	200
Cap (pF)	0.5	A	A	A	C	C	C	G	G	G	G	E	E	E	E	J	J	J	J	J	J
	1.0	A	A	A	C	C	C	G	G	G	G	E	E	E	E	J	J	J	J	J	J
	1.2	A	A	A	C	C	C	G	G	G	G	E	E	E	E	J	J	J	J	J	J
	1.5	A	A	A	C	C	C	G	G	G	G	E	E	E	E	J	J	J	J	J	J
	1.8	A	A	A	C	C	C	G	G	G	G	E	E	E	E	J	J	J	J	J	J
2.2	A	A	A	C	C	C	G	G	G	G	E	E	E	E	J	J	J	J	J	J	
2.7	A	A	A	C	C	C	G	G	G	G	E	E	E	E	J	J	J	J	J	J	
3.3	A	A	A	C	C	C	G	G	G	G	E	E	E	E	J	J	J	J	J	J	
3.9	A	A	A	C	C	C	G	G	G	G	E	E	E	E	J	J	J	J	J	J	
4.7	A	A	A	C	C	C	G	G	G	G	E	E	E	E	J	J	J	J	J	J	
5.6	A	A	A	C	C	C	G	G	G	G	E	E	E	E	J	J	J	J	J	J	
6.8	A	A	A	C	C	C	G	G	G	G	E	E	E	E	J	J	J	J	J	J	
8.2	A	A	A	C	C	C	G	G	G	G	E	E	E	E	J	J	J	J	J	J	
10	A	A	A	C	C	C	G	G	G	G	E	E	E	E	J	J	J	J	J	J	
12	A	A	A	C	C	C	G	G	G	G	E	E	E	E	J	J	J	J	J	J	
15	A	A	A	C	C	C	G	G	G	G	E	E	E	E	J	J	J	J	J	J	
18	A	A	A	C	C	C	G	G	G	G	E	E	E	E	J	J	J	J	J	J	
22	A	A	A	C	C	C	G	G	G	G	E	E	E	E	J	J	J	J	J	J	
27	A	A	A	C	C	C	G	G	G	G	E	E	E	E	J	J	J	J	J	J	
33	A	A	A	C	C	C	G	G	G	G	E	E	E	E	J	J	J	J	J	J	
39	A	A	A	C	C	C	G	G	G	G	E	E	E	E	J	J	J	J	J	J	
47	A	A	A	C	C	C	G	G	G	G	E	E	E	E	J	J	J	J	J	J	
56	A	A	A	C	C	C	G	G	G	G	E	E	E	E	J	J	J	J	J	J	
68	A	A	A	C	C	C	G	G	G	G	E	E	E	E	J	J	J	J	J	J	
82	A	A	A	C	C	C	G	G	G	G	E	E	E	E	J	J	J	J	J	J	
100	A	A	A	C	C	C	G	G	G	G	E	E	E	E	J	J	J	J	J	J	
120				C	C	C	G	G	G	G	E	E	E	E	J	J	J	J	J	J	
150				C	C	C	G	G	G	G	E	E	E	E	J	J	J	J	J	J	
180				C	C	C	G	G	G	G	E	E	E	E	J	J	J	J	J	J	
220				C	C	C	G	G	G	G	E	E	E	E	J	J	J	J	J	J	
270				C	C	C	G	G	G	G	E	E	E	E	J	M	J	J	J	J	
330				C	C	C	G	G	G	G	E	E	E	E	J	M	J	J	J	J	
390							G	G	G	G	J	J	J	J	M	J	J	J	J	J	
470							G	G	G	G	J	J	J	J	M	J	J	J	J	J	
560							G	G	G	G	J	J	J	J		J	J	J	J	J	
680							G	G	G	G	J	J	J	J		J	J	J	J	J	
820							G	G	G	G	J	J	J	J		J	J	J	J	M	
1000							G	G	G	G	J	J	J	J		J	J	J	J	Q	
1200							G	G	G	G	J	J	J	J		J	J	J	J	Q	
1500							G	G	G	G	J	J	J	J		J	J	J	M	Q	
1800												J	J	J		J	J	M	M		
2200												J	J	M		J	J	M	P		
2700												J	J	M		J	J	M	P		
3300												N	N	M		J	J	M	P		
3900												N	N	M		J	J	M	P		
4700												N	N			J	J	M	P		
5600												N	N			J	J	M			
6800												N	N			M	M				
8200												N	N			M	M				
Cap (µF)	0.010																M	M			
	0.012																M	M			
	0.015																M	M			
	0.018																	M	M		
	0.022																	M	M		
0.027																		M	M		
0.033																					
0.039																					
0.047																					
0.068																					
0.082																					
0.1																					
WVDC		10	16	25	16	25	50	6.3	25	50	100	16	25	50	100	200	16	25	50	100	200
SIZE		0201			0402			0603				0805					1206				
Letter	A	C	E	G	J	K	M	N	P	Q	X	Y	Z	BB	CC						
Max. Thickness	0.33 (0.013)	0.56 (0.022)	0.71 (0.028)	0.86 (0.034)	0.94 (0.037)	1.02 (0.040)	1.27 (0.050)	1.40 (0.055)	1.52 (0.060)	1.78 (0.070)	2.29 (0.090)	2.54 (0.100)	2.79 (0.110)	3.05 (0.120)	3.175 (0.125)						
	PAPER							EMBOSS													

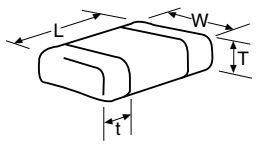

Contact Factory for Multiples



COG (NP0) Dielectric



Capacitance Range

PREFERRED SIZES ARE SHADED

SIZE		1210				1812				1825			2220			2225		
Soldering		Reflow/Wave				Reflow Only				Reflow Only			Reflow Only			Reflow Only		
Packaging		Paper/Embossed				All Embossed				All Embossed			All Embossed			All Embossed		
(L) Length	MM	3.20 ± 0.20				4.50 ± 0.30				4.50 ± 0.30			5.70 ± 0.40			5.72 ± 0.25		
	(in.)	(0.126 ± 0.008)				(0.177 ± 0.012)				(0.177 ± 0.012)			(0.224 ± 0.016)			(0.225 ± 0.010)		
(W) Width	MM	2.50 ± 0.20				3.20 ± 0.20				6.40 ± 0.40			5.00 ± 0.40			6.35 ± 0.25		
	(in.)	(0.098 ± 0.008)				(0.126 ± 0.008)				(0.252 ± 0.016)			(0.197 ± 0.016)			(0.250 ± 0.010)		
(t) Terminal	MM	0.50 ± 0.25				0.61 ± 0.36				0.61 ± 0.36			0.64 ± 0.39			0.64 ± 0.39		
	(in.)	(0.020 ± 0.010)				(0.024 ± 0.014)				(0.024 ± 0.014)			(0.025 ± 0.015)			(0.025 ± 0.015)		
WVDC		25	50	100	200	25	50	100	200	50	100	200	50	100	200	50	100	200
Cap (pF)	0.5																	
	1.0																	
	1.2																	
	1.5																	
	1.8																	
2.2	2.2																	
	2.7																	
	3.3																	
3.9	3.9																	
	4.7																	
5.6	5.6																	
	6.8																	
	8.2																	
10	10																	
	12																	
	15																	
18	18																	
	22																	
	27																	
33	33																	
	39																	
	47																	
56	56																	
	68																	
	82																	
100	100																	
	120																	
	150																	
180	180																	
	220																	
	270																	
330	330																	
	390																	
	470																	
560	560	J	J	J	J													
	680	J	J	J	J													
	820	J	J	J	J													
1000	1000	J	J	J	J	K	K	K	K	M	M	M	X	X	X	P	P	P
	1200	J	J	J	J	K	K	K	K	M	M	M	X	X	X	P	P	P
	1500	J	J	J	J	K	K	K	K	M	M	M	X	X	X	P	P	P
1800	1800	J	J	J	J	K	K	K	K	M	M	M	X	X	X	P	P	P
	2200	J	J	J	M	K	K	K	K	M	M	M	X	X	X	P	P	P
	2700	J	J	J	M	K	K	K	K	M	M	M	X	X	X	P	P	P
3300	3300	J	J	J	M	K	K	K	P	M	M	M	X	X	X	P	P	P
	3900	J	J	J	M	K	K	K	P	M	M	M	X	X	X	P	P	P
	4700	J	J	J	M	K	K	K	P	M	M	M	X	X	X	P	P	P
5600	5600	J	J	J	M	K	M	M	P	M	M	M	X	X	X	P	P	P
	6800	J	J	J	M	K	M	M	X	M	M	M	X	X	X	P	P	P
	8200	J	J	J	M	K	P	X	X	M	M	M	X	X	X	P	P	P
Cap (µF)	0.010	N	N	N		K	P	X	X	M	M		X	X	X	P	P	P
	0.012	N	N	N		K	P	X	X	M	M		X	X	X	P	P	P
	0.015	N	N	N		M	P	X	X	P	M		X	X	X	P	P	Y
0.018	0.018					M	P			P	M		X	X	X	P	P	Y
	0.022					M	CC			P			X	X	X	P	Y	Y
	0.027					M	CC			P			X	X	X	P	Y	Y
0.033	0.033					M	CC			P			X	X	X	P	Y	Y
	0.039					M	CC			P			X	X	X	P	Y	Y
	0.047					CC	CC			P			X	X	X	P	Y	Y
0.068	0.068					CC	CC									P		
	0.082					CC	CC									P		
	0.1					CC	CC									P		
WVDC		25	50	100	200	25	50	100	200	50	100	200	50	100	200	50	100	200
SIZE		1210				1812				1825			2220			2225		
Letter	A	C	E	G	J	K	M	N	P	Q	X	Y	Z	BB	CC			
Max. Thickness	0.33 (0.013)	0.56 (0.022)	0.71 (0.028)	0.86 (0.034)	0.94 (0.037)	1.02 (0.040)	1.27 (0.050)	1.40 (0.055)	1.52 (0.060)	1.78 (0.070)	2.29 (0.090)	2.54 (0.100)	2.79 (0.110)	3.05 (0.120)	3.175 (0.125)			
PAPER						EMBOSS												

Contact Factory for Multiples



C0G (NP0) Capacitors for RF/Microwave

Ultra Low ESR, “U” Series, C0G (NP0) Chip Capacitors

GENERAL INFORMATION

“U” Series capacitors are C0G (NP0) chip capacitors specially designed for “Ultra” low ESR for applications in the communications market. Max ESR and effective capacitance

are met on each value producing lot to lot uniformity. Sizes available are EIA chip sizes 0603, 0805, and 1210.

DIMENSIONS: inches (millimeters)

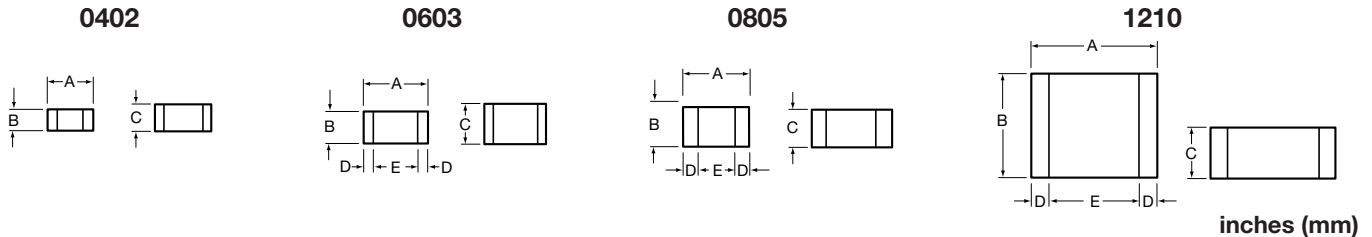

Size	A	B	C	D	E
0402	0.039 ± 0.004 (1.00 ± 0.10)	0.020 ± 0.004 (0.50 ± 0.10)	0.024 (0.60) max.	N/A	N/A
0603	0.060 ± 0.010 (1.52 ± 0.25)	0.030 ± 0.010 (0.76 ± 0.25)	0.036 (0.91) max.	0.010 ± 0.005 (0.25 ± 0.13)	0.030 (0.76) min.
0805	0.079 ± 0.008 (2.01 ± 0.20)	0.049 ± 0.008 (1.25 ± 0.20)	0.040 ± 0.005 (1.02 ± 0.127)	0.020 ± 0.010 (0.51 ± 0.255)	0.020 (0.51) min.
1210	0.126 ± 0.008 (3.2 ± 0.20)	0.098 ± 0.008 (2.49 ± 0.20)	0.050 ± 0.005 (1.27 ± 0.127)	0.025 ± 0.015 (0.635 ± 0.381)	0.040 (1.02) min.

HOW TO ORDER

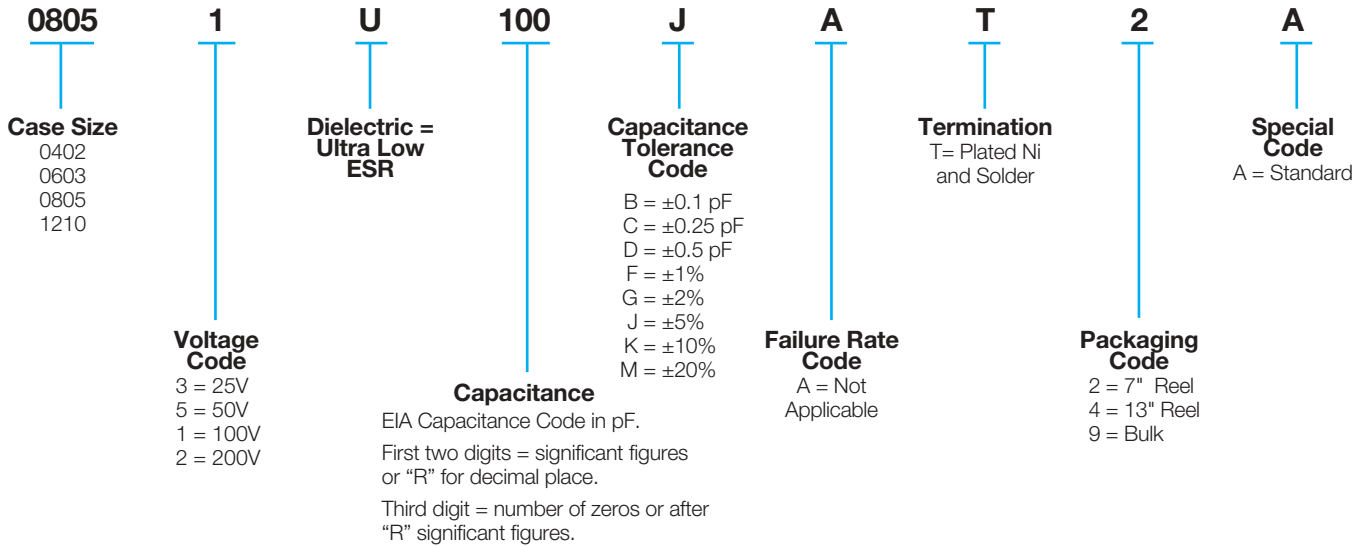

ELECTRICAL CHARACTERISTICS

Capacitance Values and Tolerances:

- Size 0402 - 0.2 pF to 22 pF @ 1 MHz
- Size 0603 - 1.0 pF to 100 pF @ 1 MHz
- Size 0805 - 1.6 pF to 160 pF @ 1 MHz
- Size 1210 - 2.4 pF to 1000 pF @ 1 MHz

Temperature Coefficient of Capacitance (TC):

0 ± 30 ppm/°C (-55° to +125°C)

Insulation Resistance (IR):

- 10¹² Ω min. @ 25°C and rated WVDC
- 10¹¹ Ω min. @ 125°C and rated WVDC

Working Voltage (WVDC):

- Size Working Voltage
- 0402 - 50 WVDC
- 0603 - 200, 100, 50 WVDC
- 0805 - 200, 100 WVDC
- 1210 - 200, 100 WVDC

Dielectric Working Voltage (DWV):

250% of rated WVDC

Equivalent Series Resistance Typical (ESR):

- 0402 - See Performance Curve, page 9
- 0603 - See Performance Curve, page 9
- 0805 - See Performance Curve, page 9
- 1210 - See Performance Curve, page 9

Marking: Laser marking EIA J marking standard (except 0603) (capacitance code and tolerance upon request).

MILITARY SPECIFICATIONS

Meets or exceeds the requirements of MIL-C-55681

C0G (NP0) Capacitors for RF/Microwave

Ultra Low ESR, "U" Series, C0G (NP0) Chip Capacitors

CAPACITANCE RANGE

Cap (pF)	Available	Size			
	Tolerance	0402	0603	0805	1210
0.2	B,C	50V	N/A	N/A	N/A
0.3	↑	↓	↓	↓	↓
0.4	↓	↓	↓	↓	↓
0.5	B,C	↓	↓	↓	↓
0.6	B,C,D	↓	↓	↓	↓
0.7	↑	↓	↓	↓	↓
0.8	↓	↓	↓	↓	↓
0.9	B,C,D	↓	↓	↓	↓

Cap (pF)	Available	Size			
	Tolerance	0402	0603	0805	1210
1.0	B,C,D	50V	200V	N/A	N/A
1.1	↑	↓	↓	↓	↓
1.2	↑	↓	↓	↓	↓
1.3	↑	↓	↓	↓	↓
1.4	↑	↓	↓	↓	↓
1.5	↑	↓	↓	200	↓
1.6	↑	↓	↓	↓	↓
1.7	↑	↓	↓	↓	↓
1.8	↑	↓	↓	↓	↓
1.9	↑	↓	↓	↓	↓
2.0	↑	↓	↓	↓	↓
2.1	↑	↓	↓	↓	↓
2.2	↑	↓	↓	↓	↓
2.4	↑	↓	↓	↓	↓
2.7	↑	↓	↓	↓	↓
3.0	↑	↓	↓	↓	↓
3.3	↑	↓	↓	↓	↓
3.6	↑	↓	↓	↓	↓
3.9	↑	↓	↓	↓	↓
4.3	↑	↓	↓	↓	↓
4.7	↑	↓	↓	↓	↓
5.1	↑	↓	↓	↓	↓
5.6	↑	↓	↓	↓	↓
6.2	B,C,D	↓	↓	↓	↓
6.8	B,C,J,K,M	↓	↓	↓	↓

Cap (pF)	Available	Size			
	Tolerance	0402	0603	0805	1210
7.5	B,C,J,K,M	50V	200V	200V	200V
8.2	↓	↓	↓	↓	↓
9.1	B,C,J,K,M	↓	↓	↓	↓
10	F,G,J,K,M	↓	↓	↓	↓
11	↑	↓	↓	↓	↓
12	↑	↓	↓	↓	↓
13	↑	↓	↓	↓	↓
15	↑	↓	↓	↓	↓
18	↑	↓	↓	↓	↓
20	↑	↓	↓	↓	↓
22	↑	↓	100	↓	↓
24	↑	N/A	↓	↓	↓
27	↑	↓	↓	↓	↓
30	↑	↓	↓	↓	↓
33	↑	↓	↓	↓	↓
36	↑	↓	↓	↓	↓
39	↑	↓	↓	↓	↓
43	↑	↓	↓	↓	↓
47	↑	↓	↓	↓	↓
51	↑	↓	↓	50	↓
56	↑	↓	↓	↓	↓
68	↑	↓	↓	↓	↓
75	↑	↓	↓	↓	↓
82	↑	↓	↓	↓	↓
91	F,G,J,K,M	↓	↓	↓	↓

Cap (pF)	Available	Size			
	Tolerance	0402	0603	0805	1210
100	F,G,J,K,M	N/A	100V	100V	200V
110	↑	↓	N/A	↓	↓
120	↑	↓	↓	↓	↓
130	↑	↓	↓	↓	↓
140	↑	↓	↓	↓	↓
150	↑	↓	↓	↓	↓
160	↑	↓	↓	↓	↓
180	↑	↓	↓	↓	↓
200	↑	↓	↓	↓	↓
220	↑	↓	↓	↓	↓
270	↑	↓	↓	↓	↓
300	↑	↓	↓	↓	↓
330	↑	↓	↓	↓	↓
360	↑	↓	↓	↓	↓
390	↑	↓	↓	↓	↓
430	↑	↓	↓	↓	↓
470	↑	↓	↓	↓	↓
510	↑	↓	↓	↓	↓
560	↑	↓	↓	↓	↓
620	↑	↓	↓	↓	↓
680	↑	↓	↓	↓	↓
750	↑	↓	↓	↓	↓
820	↑	↓	↓	↓	↓
910	↑	↓	↓	↓	↓
1000	F,G,J,K,M	↓	↓	↓	↓

ULTRA LOW ESR, "U" SERIES

TYPICAL ESR vs. FREQUENCY
0402 "U" SERIES

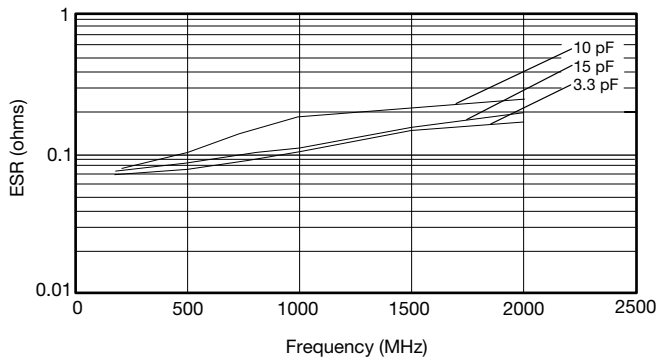

TYPICAL ESR vs. FREQUENCY
0603 "U" SERIES

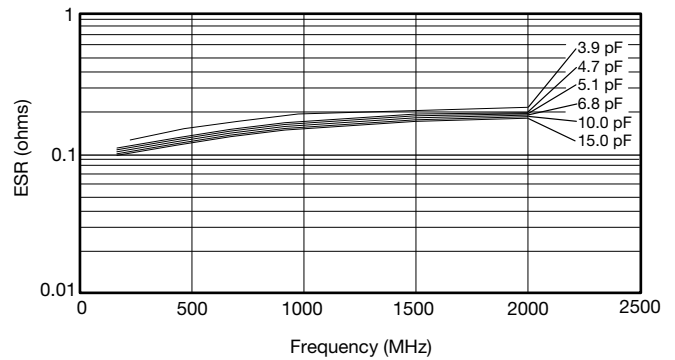

TYPICAL ESR vs. FREQUENCY
0805 "U" SERIES

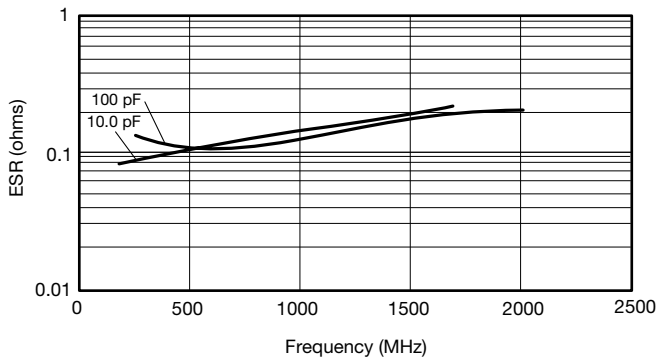

TYPICAL ESR vs. FREQUENCY
1210 "U" SERIES

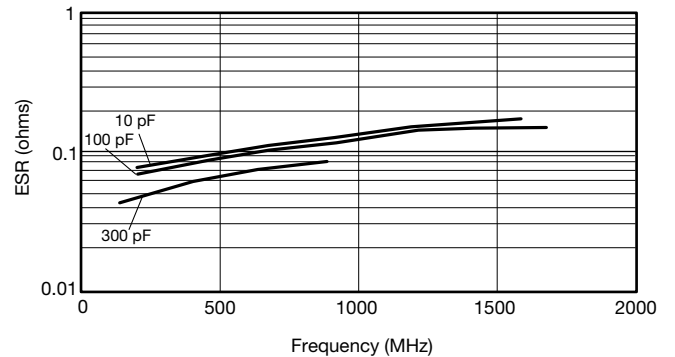

ESR Measured on the Boonton 34A

C0G (NP0) Capacitors for RF/Microwave



Ultra Low ESR, "U" Series, C0G (NP0) Chip Capacitors

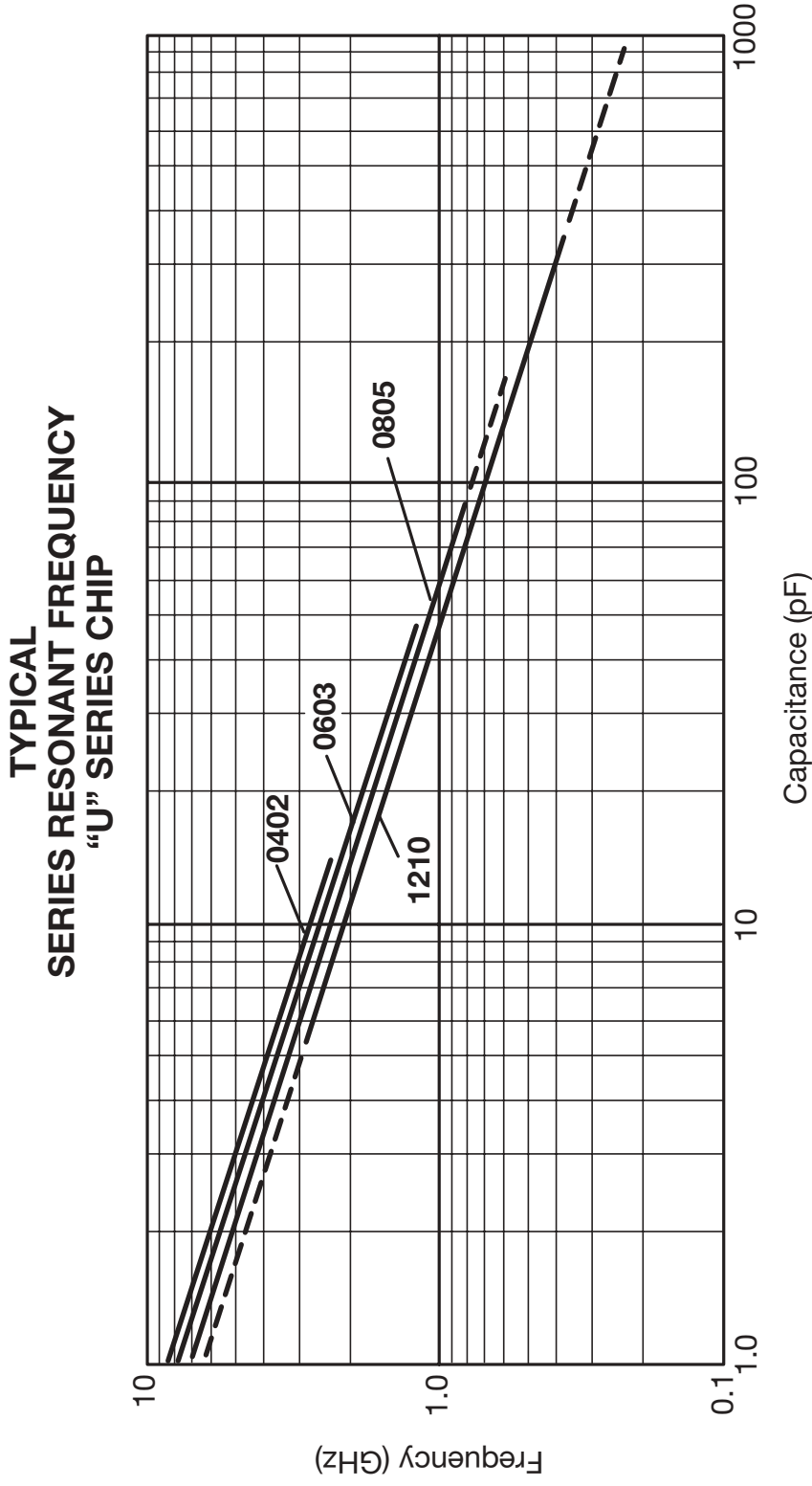

X7R Dielectric

General Specifications

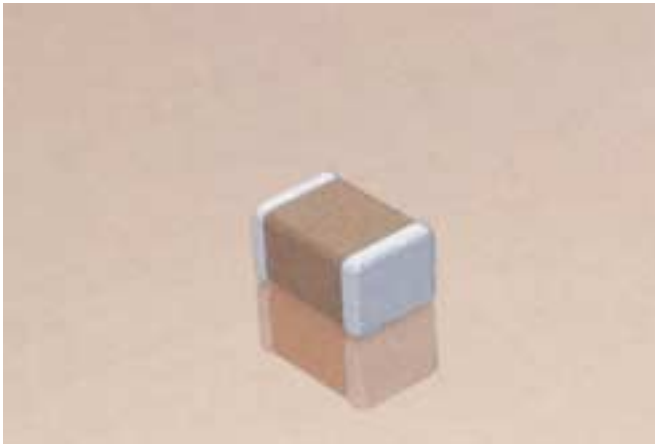

X7R formulations are called "temperature stable" ceramics and fall into EIA Class II materials. X7R is the most popular of these intermediate dielectric constant materials. Its temperature variation of capacitance is within $\pm 15\%$ from -55°C to $+125^\circ\text{C}$. This capacitance change is non-linear.

Capacitance for X7R varies under the influence of electrical operating conditions such as voltage and frequency.

X7R dielectric chip usage covers the broad spectrum of industrial applications where known changes in capacitance due to applied voltages are acceptable.

PART NUMBER (see page 2 for complete part number explanation)

0805

Size
(L" x W")

5

Voltage
6.3V = 6
10V = Z
16V = Y
25V = 3
50V = 5
100V = 1
200V = 2

C

Dielectric
X7R = C

103

Capacitance Code (In pF)
2 Sig. Digits + Number of Zeros

M

Capacitance Tolerance
Preferred
J = $\pm 5\%$
K = $\pm 10\%$
M = $\pm 20\%$

A

Failure Rate
A = Not Applicable

T

Terminations
T = Plated Ni and Sn
7 = Gold Plated

2

Packaging
2 = 7" Reel
4 = 13" Reel
7 = Bulk Cass.
9 = Bulk

A

Special Code
A = Std. Product

Contact Factory For Multiples

X7R Dielectric Typical Temperature Coefficient

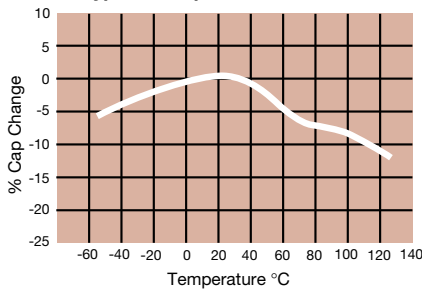

Δ Capacitance vs. Frequency

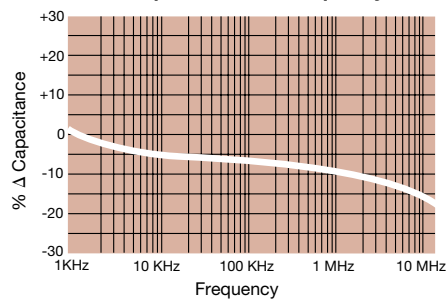

Insulation Resistance vs Temperature

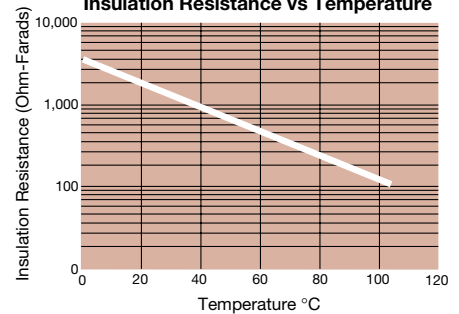

Variation of Impedance with Cap Value Impedance vs. Frequency 1,000 pF vs. 10,000 pF - X7R 0805

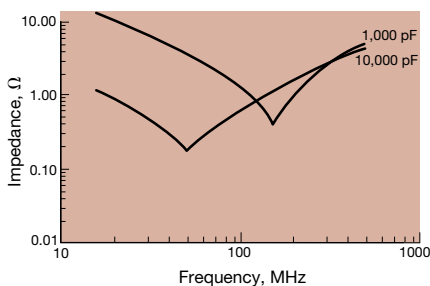

Variation of Impedance with Chip Size Impedance vs. Frequency 10,000 pF - X7R

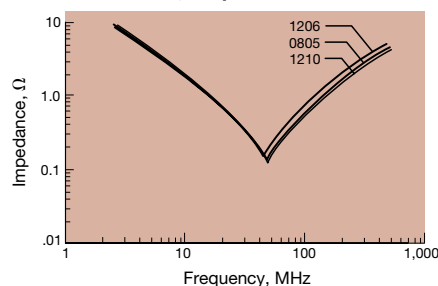

Variation of Impedance with Chip Size Impedance vs. Frequency 100,000 pF - X7R

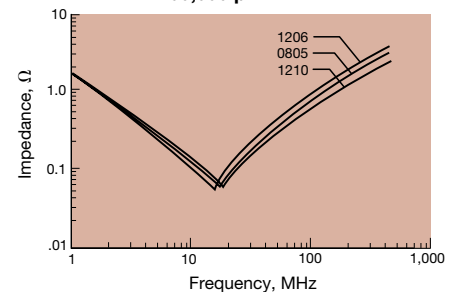

Specifications and Test Methods

Parameter/Test		X7R Specification Limits	Measuring Conditions	
Operating Temperature Range		-55°C to +125°C	Temperature Cycle Chamber	
Capacitance		Within specified tolerance	Freq.: 1.0 kHz \pm 10% Voltage: 1.0Vrms \pm .2V For Cap > 10 μ F, 0.5Vrms @ 120Hz	
Dissipation Factor		\leq 2.5% for \geq 50V DC rating \leq 3.0% for 25V DC rating \leq 3.5% for 16V DC rating \leq 5.0% for \leq 10V DC rating		
Insulation Resistance		100,000M Ω or 1000M Ω - μ F, whichever is less	Charge device with rated voltage for 60 \pm 5 secs @ room temp/humidity	
Dielectric Strength		No breakdown or visual defects	Charge device with 300% of rated voltage for 1-5 seconds, w/charge and discharge current limited to 50 mA (max)	
Resistance to Flexure Stresses	Appearance	No defects	Deflection: 2mm Test Time: 30 seconds 	
	Capacitance Variation	$\leq \pm 12\%$		
	Dissipation Factor	Meets Initial Values (As Above)		
	Insulation Resistance	\geq Initial Value x 0.3		
Solderability		\geq 95% of each terminal should be covered with fresh solder	Dip device in eutectic solder at 230 \pm 5°C for 5.0 \pm 0.5 seconds	
Resistance to Solder Heat	Appearance	No defects, <25% leaching of either end terminal	Dip device in eutectic solder at 260°C for 60 seconds. Store at room temperature for 24 \pm 2 hours before measuring electrical properties.	
	Capacitance Variation	$\leq \pm 7.5\%$		
	Dissipation Factor	Meets Initial Values (As Above)		
	Insulation Resistance	Meets Initial Values (As Above)		
	Dielectric Strength	Meets Initial Values (As Above)		
Thermal Shock	Appearance	No visual defects	Step 1: -55°C \pm 2°	30 \pm 3 minutes
	Capacitance Variation	$\leq \pm 7.5\%$	Step 2: Room Temp	\leq 3 minutes
	Dissipation Factor	Meets Initial Values (As Above)	Step 3: +125°C \pm 2°	30 \pm 3 minutes
	Insulation Resistance	Meets Initial Values (As Above)	Step 4: Room Temp	\leq 3 minutes
	Dielectric Strength	Meets Initial Values (As Above)	Repeat for 5 cycles and measure after 24 \pm 2 hours at room temperature	
Load Life	Appearance	No visual defects	Charge device with twice rated voltage in test chamber set at 125°C \pm 2°C for 1000 hours (+48, -0) Remove from test chamber and stabilize at room temperature for 24 \pm 2 hours before measuring.	
	Capacitance Variation	$\leq \pm 12.5\%$		
	Dissipation Factor	\leq Initial Value x 2.0 (See Above)		
	Insulation Resistance	\geq Initial Value x 0.3 (See Above)		
	Dielectric Strength	Meets Initial Values (As Above)		
Load Humidity	Appearance	No visual defects	Store in a test chamber set at 85°C \pm 2°C/ 85% \pm 5% relative humidity for 1000 hours (+48, -0) with rated voltage applied. Remove from chamber and stabilize at room temperature and humidity for 24 \pm 2 hours before measuring.	
	Capacitance Variation	$\leq \pm 12.5\%$		
	Dissipation Factor	\leq Initial Value x 2.0 (See Above)		
	Insulation Resistance	\geq Initial Value x 0.3 (See Above)		
	Dielectric Strength	Meets Initial Values (As Above)		

X7R Dielectric

Capacitance Range



PREFERRED SIZES ARE SHADED

SIZE	0201		0402				0603						0805						1206									
Soldering	Reflow Only		Reflow Only				Reflow/Wave						Reflow/Wave						Reflow/Wave									
Packaging	All Paper		All Paper				All Paper						Paper/Embossed						Paper/Embossed									
(L) Length	MM (in.)	0.60 ± 0.03 (0.024 ± 0.001)	1.00 ± 0.10 (0.040 ± 0.004)				1.60 ± 0.15 (0.063 ± 0.006)						2.01 ± 0.20 (0.079 ± 0.008)						3.20 ± 0.20 (0.126 ± 0.008)									
(W) Width	MM (in.)	0.30 ± 0.03 (0.011 ± 0.001)	0.50 ± 0.10 (0.020 ± 0.004)				0.81 ± 0.15 (0.032 ± 0.006)						1.25 ± 0.20 (0.049 ± 0.008)						1.60 ± 0.20 (0.063 ± 0.008)									
(t) Terminal	MM (in.)	0.15 ± 0.05 (0.006 ± 0.002)	0.25 ± 0.15 (0.010 ± 0.006)				0.35 ± 0.15 (0.014 ± 0.006)						0.50 ± 0.25 (0.020 ± 0.010)						0.50 ± 0.25 (0.020 ± 0.010)									
WVDC		10 16	6.3 10 16 25 50	6.3 10 16 25 50 100 200	6.3 10 16 25 50 100 200	10 16 25 50 100 200	10 16 25 50 100 200	10 16 25 50 100 200	10 16 25 50 100 200	10 16 25 50 100 200	10 16 25 50 100 200	10 16 25 50 100 200	10 16 25 50 100 200	10 16 25 50 100 200	10 16 25 50 100 200	10 16 25 50 100 200	10 16 25 50 100 200											
Cap (pF)		100 120 150	A A C C C C C C	C C C C C C C C	C C C C C C C C	C C C C C C C C	C C C C C C C C	C C C C C C C C	C C C C C C C C	C C C C C C C C	C C C C C C C C	C C C C C C C C	C C C C C C C C	C C C C C C C C	C C C C C C C C	C C C C C C C C	C C C C C C C C	C C C C C C C C										
Cap. (µF)		0.010 0.012 0.015	C C C C C C	C C C C C C	C C C C C C	C C C C C C	C C C C C C	C C C C C C	C C C C C C	C C C C C C	C C C C C C	C C C C C C	C C C C C C	C C C C C C	C C C C C C	C C C C C C	C C C C C C	C C C C C C										
Cap. (µF)		0.018 0.022 0.027	C C C C	C C C C	C C C C	C C C C	C C C C	C C C C	C C C C	C C C C	C C C C	C C C C	C C C C	C C C C	C C C C	C C C C	C C C C	C C C C										
Cap. (µF)		0.033 0.039 0.047	C C C	C C C	C C C	C C C	C C C	C C C	C C C	C C C	C C C	C C C	C C C	C C C	C C C	C C C	C C C	C C C										
Cap. (µF)		0.056 0.068 0.082																										
Cap. (µF)		0.10 0.12 0.15																										
Cap. (µF)		0.18 0.22 0.27																										
Cap. (µF)		0.33 0.47 0.56																										
Cap. (µF)		0.68 0.82 1.0																										
Cap. (µF)		1.2 1.5 1.8																										
Cap. (µF)		2.2 3.3 4.7																										
Cap. (µF)		10 22 47 100																										
WVDC		10 16	6.3 10 16 25 50	6.3 10 16 25 50 100 200	6.3 10 16 25 50 100 200	10 16 25 50 100 200	10 16 25 50 100 200	10 16 25 50 100 200	10 16 25 50 100 200	10 16 25 50 100 200	10 16 25 50 100 200	10 16 25 50 100 200	10 16 25 50 100 200	10 16 25 50 100 200	10 16 25 50 100 200	10 16 25 50 100 200	10 16 25 50 100 200											
SIZE	0201	0402				0603						0805						1206										
Letter	A	C	E	G	J	K	M	N	P	Q	X	Y	Z	BB	CC													
Max. Thickness	0.33 (0.013)	0.56 (0.022)	0.71 (0.028)	0.86 (0.034)	0.94 (0.037)	1.02 (0.040)	1.27 (0.050)	1.40 (0.055)	1.52 (0.060)	1.78 (0.070)	2.29 (0.090)	2.54 (0.100)	2.79 (0.110)	3.05 (0.120)	3.175 (0.125)													
	PAPER										EMBOSSED																	

Contact Factory for Multiples

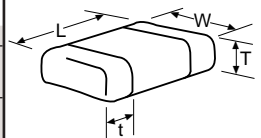

X7R Dielectric



Capacitance Range

PREFERRED SIZES ARE SHADED

SIZE		1210					1812				1825		2220			2225	
Soldering		Reflow/Wave					Reflow Only				Reflow Only		Reflow Only			Reflow Only	
Packaging		Paper/Embossed					All Embossed				All Embossed		All Embossed			All Embossed	
(L) Length	MM (in.)	3.20 ± 0.20 (0.126 ± 0.008)					4.50 ± 0.30 (0.177 ± 0.012)				4.50 ± 0.30 (0.177 ± 0.012)		5.7 ± 0.40 (0.224 ± 0.016)			5.72 ± 0.25 (0.225 ± 0.010)	
(W) Width	MM (in.)	2.50 ± 0.20 (0.098 ± 0.008)					3.20 ± 0.20 (0.126 ± 0.008)				6.40 ± 0.40 (0.252 ± 0.016)		5.0 ± 0.40 (0.197 ± 0.016)			6.35 ± 0.25 (0.250 ± 0.010)	
(t) Terminal	MM (in.)	0.50 ± 0.25 (0.020 ± 0.010)					0.61 ± 0.36 (0.024 ± 0.014)				0.61 ± 0.36 (0.024 ± 0.014)		0.64 ± 0.39 (0.025 ± 0.015)			0.64 ± 0.39 (0.025 ± 0.015)	
WVDC		10	16	25	50	100	16	25	50	100	50	100	50	100	200	50	100
Cap (pF)	100																
	120																
	150																
	180																
	220																
	270																
	330																
	390																
	470																
	560																
	680																
	820																
	1000	J	J	J	J	J											
	1200	J	J	J	J	J											
	1500	J	J	J	J	J											
	1800	J	J	J	J	J											
	2200	J	J	J	J	J											
	2700	J	J	J	J	J											
	3300	J	J	J	J	J											
	3900	J	J	J	J	J											
	4700	J	J	J	J	J											
	5600	J	J	J	J	J											
	6800	J	J	J	J	J											
	8200	J	J	J	J	J											
Cap. (µF)	0.010	J	J	J	J	J			K	K	M	M	X	X	X	M	M
	0.012	J	J	J	J	J			K	K	M	M	X	X	X	M	M
	0.015	J	J	J	J	J			K	K	M	M	X	X	X	M	M
	0.018	J	J	J	J	J			K	K	M	M	X	X	X	M	M
	0.022	J	J	J	J	J			K	K	M	M	X	X	X	M	M
	0.027	J	J	J	J	J			K	K	M	M	X	X	X	M	M
	0.033	J	J	J	J	J			K	K	M	M	X	X	X	M	M
	0.039	J	J	J	J	J			K	K	M	M	X	X	X	M	M
	0.047	J	J	J	J	J			K	K	M	M	X	X	X	M	M
	0.056	J	J	J	J	J			K	K	M	M	X	X	X	M	M
	0.068	J	J	J	J	J			K	K	M	M	X	X	X	M	M
	0.082	J	J	J	J	J			K	K	M	M	X	X	X	M	M
	0.10	J	J	J	J	J			K	K	M	M	X	X	X	M	M
	0.12	J	J	J	J	M			K	K	M	M	X	X	X	M	M
	0.15	J	J	J	J	M			K	K	M	M	X	X	X	M	M
	0.18	J	J	J	J	P			K	K	M	M	X	X	X	M	M
	0.22	J	J	J	J	P			K	K	M	M	X	X	X	M	M
	0.27	J	J	J	J	Z			K	M	M	M	X	X	X	M	M
	0.33	J	J	J	J	Z			K	M	M	M	X	X	X	M	M
	0.47	M	M	M	M	Z			K	P	M	M	X	X	X	M	M
	0.56	M	M	M	M	Z			M	Q	M	M	X	X	X	M	M
	0.68	M	M	P		Z			M	X	M	Q	X	X		M	M
	0.82	M	M	P		Z			M	X	M	Q	X	X		M	M
	1.0	N	N	P	X	Z			M	X	M	Q	X	X		M	M
	1.2	N	N					M			M		X			M	P
	1.5	N	N								M					M	P
	1.8	N	N	P							M					M	P
	2.2			X									Z			M	
	3.3																
	4.7	Q	Z														
	10						Z										
	22																
	47																
	100																
WVDC		10	16	25	50	100	16	25	50	100	50	100	50	100	200	50	100
SIZE		1210					1812				1825		2220			2225	
Letter		A	C	E	G	J	K	M	N	P	Q	X	Y	Z	BB	CC	
Max. Thickness		0.33 (0.013)	0.56 (0.022)	0.71 (0.028)	0.86 (0.034)	0.94 (0.037)	1.02 (0.040)	1.27 (0.050)	1.40 (0.055)	1.52 (0.060)	1.78 (0.070)	2.29 (0.090)	2.54 (0.100)	2.79 (0.110)	3.05 (0.120)	3.175 (0.125)	
		PAPER					EMBOSS										

Contact Factory for Multiples



X5R Dielectric

General Specifications

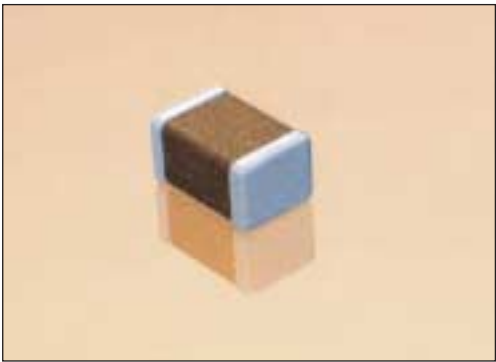

GENERAL DESCRIPTION

- General Purpose Dielectric for Ceramic Capacitors
- EIA Class II Dielectric
- Temperature variation of capacitance is within $\pm 15\%$ from -55°C to $+85^{\circ}\text{C}$
- Well suited for decoupling and filtering applications
- Available in High Capacitance values (up to $100\mu\text{F}$)

PART NUMBER (see page 2 for complete part number explanation)

2220

Size
(L" x W")

6

Voltage
4 = 4V
6 = 6.3V
Z = 10V
Y = 16V
3 = 25V
D = 35V

D

Dielectric
D = X5R

107

Capacitance Code (In pF)
2 Sig. Digits + Number of Zeros

M

Capacitance Tolerance
K = $\pm 10\%$
M = $\pm 20\%$

A

Failure Rate
A = N/A

T

Terminations
T = Plated Ni and Sn

2

Packaging
2 = 7" Reel
4 = 13" Reel
7 = Bulk Cass.
9 = Bulk

A

Special Code
A = Std.

TYPICAL ELECTRICAL CHARACTERISTICS

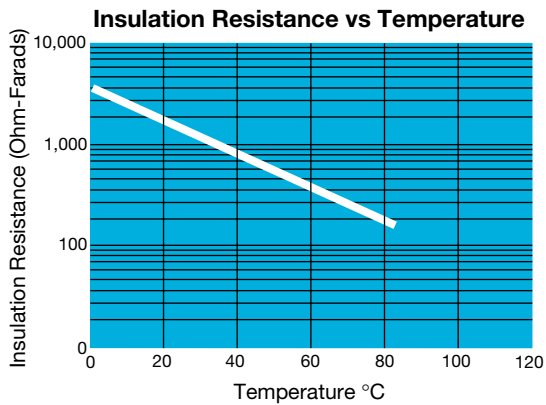
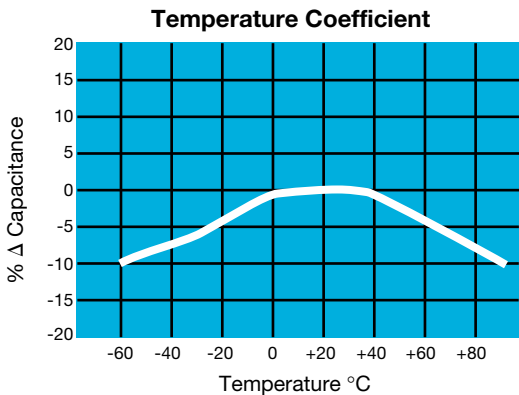

Specifications and Test Methods

Parameter/Test		X5R Specification Limits	Measuring Conditions	
Operating Temperature Range		-55°C to +85°C	Temperature Cycle Chamber	
Capacitance		Within specified tolerance	Freq.: 1.0 kHz ± 10% Voltage: 1.0Vrms ± .2V For Cap > 10 µF, 0.5Vrms @ 120Hz	
Dissipation Factor		≤ 2.5% for ≥ 50V DC rating ≤ 3.0% for 25V DC rating ≤ 3.5% for 16V DC rating ≤ 5.0% for ≤ 10V DC rating		
Insulation Resistance		100,000MΩ or 500MΩ - µF, whichever is less	Charge device with rated voltage for 60 ± 5 secs @ room temp/humidity	
Dielectric Strength		No breakdown or visual defects	Charge device with 300% of rated voltage for 1-5 seconds, w/charge and discharge current limited to 50 mA (max)	
Resistance to Flexure Stresses	Appearance	No defects	Deflection: 2mm Test Time: 30 seconds 	
	Capacitance Variation	≤ ±12%		
	Dissipation Factor	Meets Initial Values (As Above)		
	Insulation Resistance	≥ Initial Value x 0.3		
Solderability		≥ 95% of each terminal should be covered with fresh solder	Dip device in eutectic solder at 230 ± 5°C for 5.0 ± 0.5 seconds	
Resistance to Solder Heat	Appearance	No defects, <25% leaching of either end terminal	Dip device in eutectic solder at 260°C for 60 seconds. Store at room temperature for 24 ± 2 hours before measuring electrical properties.	
	Capacitance Variation	≤ ±7.5%		
	Dissipation Factor	Meets Initial Values (As Above)		
	Insulation Resistance	Meets Initial Values (As Above)		
	Dielectric Strength	Meets Initial Values (As Above)		
Thermal Shock	Appearance	No visual defects	Step 1: -55°C ± 2°	30 ± 3 minutes
	Capacitance Variation	≤ ±7.5%	Step 2: Room Temp	≤ 3 minutes
	Dissipation Factor	Meets Initial Values (As Above)	Step 3: +85°C ± 2°	30 ± 3 minutes
	Insulation Resistance	Meets Initial Values (As Above)	Step 4: Room Temp	≤ 3 minutes
	Dielectric Strength	Meets Initial Values (As Above)	Repeat for 5 cycles and measure after 24 ± 2 hours at room temperature	
Load Life	Appearance	No visual defects	Charge device with twice rated voltage in test chamber set at 85°C ± 2°C for 1000 hours (+48, -0) Remove from test chamber and stabilize at room temperature for 24 ± 2 hours before measuring.	
	Capacitance Variation	≤ ±12.5%		
	Dissipation Factor	≤ Initial Value x 2.0 (See Above)		
	Insulation Resistance	≥ Initial Value x 0.3 (See Above)		
	Dielectric Strength	Meets Initial Values (As Above)		
Load Humidity	Appearance	No visual defects	Store in a test chamber set at 85°C ± 2°C/ 85% ± 5% relative humidity for 1000 hours (+48, -0) with rated voltage applied. Remove from chamber and stabilize at room temperature and humidity for 24 ± 2 hours before measuring.	
	Capacitance Variation	≤ ±12.5%		
	Dissipation Factor	≤ Initial Value x 2.0 (See Above)		
	Insulation Resistance	≥ Initial Value x 0.3 (See Above)		
	Dielectric Strength	Meets Initial Values (As Above)		

X5R Dielectric



Capacitance Range

PREFERRED SIZES ARE SHADED

SIZE	0201		0402				0603					0805					1206					1210					1812				2220																																																																																																																													
Soldering	Reflow Only		Reflow Only				Reflow/Wave					Reflow/Wave					Reflow/Wave					Reflow Only				Reflow Only																																																																																																																																		
Packaging	All Paper		All Paper				All Paper					Paper/Embossed					Paper/Embossed					Paper/Embossed				All Embossed				All Embossed																																																																																																																														
(L) Length	MM (in.) 0.60 ± 0.03 (0.024 ± 0.001)		1.00 ± 0.10 (0.040 ± 0.004)				1.60 ± 0.15 (0.063 ± 0.006)					2.01 ± 0.20 (0.079 ± 0.008)					3.20 ± 0.20 (0.126 ± 0.008)					3.20 ± 0.20 (0.126 ± 0.008)					4.50 ± 0.30 (0.177 ± 0.012)				5.70 ± 0.40 (0.225 ± 0.016)																																																																																																																													
(W) Width	MM (in.) 0.30 ± 0.03 (0.011 ± 0.001)		0.50 ± 0.10 (0.020 ± 0.004)				0.81 ± 0.15 (0.032 ± 0.006)					1.25 ± 0.20 (0.049 ± 0.008)					1.60 ± 0.20 (0.063 ± 0.008)					2.50 ± 0.20 (0.098 ± 0.008)					3.20 ± 0.20 (0.126 ± 0.008)				5.00 ± 0.40 (0.197 ± 0.016)																																																																																																																													
(t) Terminal	MM (in.) 0.15 ± 0.05 (0.006 ± 0.002)		0.25 ± 0.15 (0.010 ± 0.006)				0.35 ± 0.15 (0.014 ± 0.006)					0.50 ± 0.25 (0.020 ± 0.010)					0.50 ± 0.25 (0.020 ± 0.010)					0.50 ± 0.25 (0.020 ± 0.010)					0.61 ± 0.36 (0.024 ± 0.014)				0.64 ± 0.39 (0.025 ± 0.015)																																																																																																																													
WVDC	10		4	6.3	10	16	4	6.3	10	16	25	6.3	10	16	25	35	6.3	10	16	25	35	4	6.3	10	16	25	35	6.3	10	16	25	6.3																																																																																																																												
Cap (pF)	100																										150																										220																										330																										470																										680																									
Cap (pF)	1000																										1200																										1500																										1800																										2200																										2700																									
Cap (pF)	3300																										3900																										4700																										5600																										6800																										8200																									
Cap (pF)	0.010																										0.012																										0.015																										0.018																										0.022																										0.027																									
Cap (pF)	0.033																										0.039																										0.047																										0.056																										0.068																										0.082																									
Cap (pF)	0.10																										0.12																										0.15																										0.18																										0.22																										0.27																									
Cap (pF)	0.33																										0.47																										0.56																										0.68																										0.82																										1.0																									
Cap (pF)	1.2																										1.5																										1.8																										2.2																										3.3																										4.7																									
Cap (pF)	6.8																										10																										22																										47																										100																										10																									
WVDC	10		4	6.3	10	16	4	6.3	10	16	25	6.3	10	16	25	35	6.3	10	16	25	35	4	6.3	10	16	25	35	6.3	10	16	25	6.3																																																																																																																												
SIZE	0201	0402				0603					0805					1206					1210					1812				2220																																																																																																																														

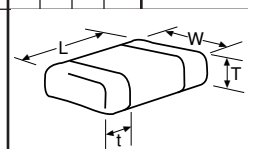

Letter	A	C	E	G	J	K	M	N	P	Q	X	Y	Z	BB	CC					
Max. Thickness	0.33 (0.013)	0.56 (0.022)	0.71 (0.028)	0.86 (0.034)	0.94 (0.037)	1.02 (0.040)	1.27 (0.050)	1.40 (0.055)	1.52 (0.060)	1.78 (0.070)	2.29 (0.090)	2.54 (0.100)	2.79 (0.110)	3.05 (0.120)	3.175 (0.125)					
	PAPER					EMBOSSED														

Contact Factory for Multiples

Y5V Dielectric

General Specifications

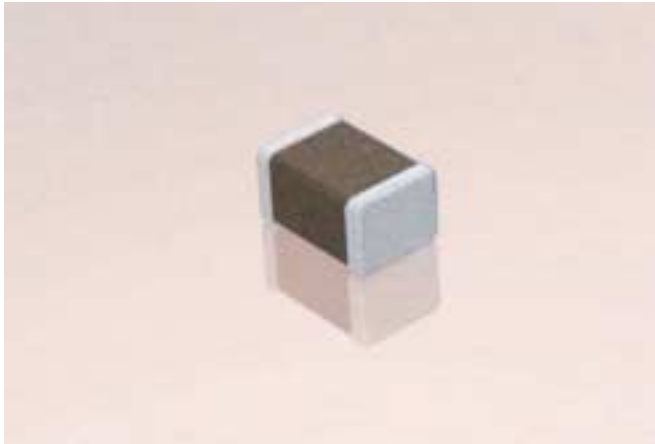

Y5V formulations are for general-purpose use in a limited temperature range. They have a wide temperature characteristic of +22% –82% capacitance change over the operating temperature range of –30°C to +85°C.

Y5V's high dielectric constant allows the manufacture of the highest capacitance value in a given case size.

These characteristics make Y5V ideal for decoupling applications within limited temperature range.

PART NUMBER (see page 2 for complete part number explanation)

0805

Size
(L" x W")

3

Voltage
6.3V = 6
10V = Z
16V = Y
25V = 3
50V = 5

G

Dielectric
Y5V = G

104

Capacitance Code (In pF)
2 Sig. Digits +
Number of
Zeros

Z

Capacitance Tolerance
Z = +80 –20%

A

Failure Rate
A = Not
Applicable

T

Terminations
T = Plated Ni
and Sn

2

Packaging
2 = 7" Reel
4 = 13" Reel

A

Special Code
A = Std.
Product

Temperature Coefficient

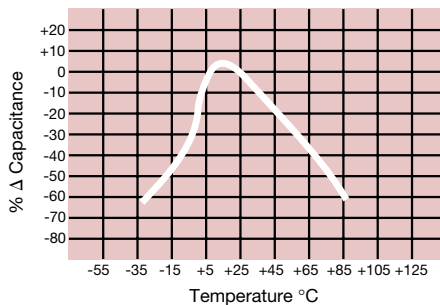

Capacitance Change vs. DC Bias Voltage

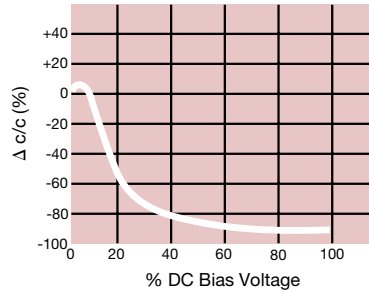

Insulation Resistance vs. Temperature

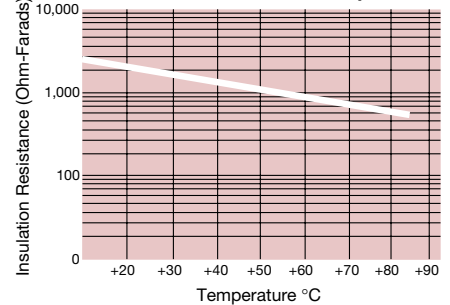

0.1 μF - 0603 Impedance vs. Frequency

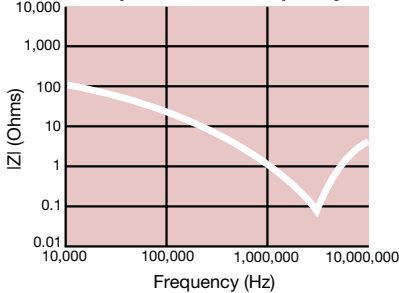

0.22 μF - 0805 Impedance vs. Frequency

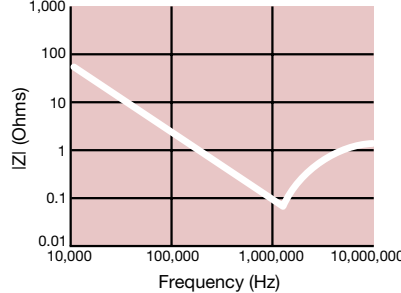

1 μF - 1206 Impedance vs. Frequency

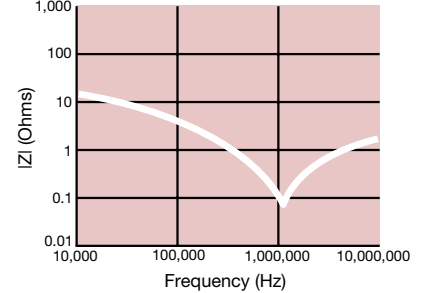

Specifications and Test Methods

Parameter/Test		Y5V Specification Limits	Measuring Conditions	
Operating Temperature Range		-30°C to +85°C	Temperature Cycle Chamber	
Capacitance		Within specified tolerance	Freq.: 1.0 kHz \pm 10% Voltage: 1.0Vrms \pm .2V For Cap > 10 μ F, 0.5Vrms @ 120Hz	
Dissipation Factor		\leq 5.0% for \geq 50V DC rating \leq 7.0% for 25V DC rating \leq 9.0% for 16V DC rating \leq 12.5% for \leq 10V DC rating		
Insulation Resistance		100,000M Ω or 500M Ω - μ F, whichever is less	Charge device with rated voltage for 60 \pm 5 secs @ room temp/humidity	
Dielectric Strength		No breakdown or visual defects	Charge device with 300% of rated voltage for 1-5 seconds, w/charge and discharge current limited to 50 mA (max)	
Resistance to Flexure Stresses	Appearance	No defects	Deflection: 2mm Test Time: 30 seconds 	
	Capacitance Variation	\leq \pm 30%		
	Dissipation Factor	Meets Initial Values (As Above)		
	Insulation Resistance	\geq Initial Value x 0.1		
Solderability		\geq 95% of each terminal should be covered with fresh solder	Dip device in eutectic solder at 230 \pm 5°C for 5.0 \pm 0.5 seconds	
Resistance to Solder Heat	Appearance	No defects, <25% leaching of either end terminal	Dip device in eutectic solder at 260°C for 60 seconds. Store at room temperature for 24 \pm 2 hours before measuring electrical properties.	
	Capacitance Variation	\leq \pm 20%		
	Dissipation Factor	Meets Initial Values (As Above)		
	Insulation Resistance	Meets Initial Values (As Above)		
	Dielectric Strength	Meets Initial Values (As Above)		
Thermal Shock	Appearance	No visual defects	Step 1: -30°C \pm 2°	30 \pm 3 minutes
	Capacitance Variation	\leq \pm 20%	Step 2: Room Temp	\leq 3 minutes
	Dissipation Factor	Meets Initial Values (As Above)	Step 3: +85°C \pm 2°	30 \pm 3 minutes
	Insulation Resistance	Meets Initial Values (As Above)	Step 4: Room Temp	\leq 3 minutes
	Dielectric Strength	Meets Initial Values (As Above)	Repeat for 5 cycles and measure after 24 \pm 2 hours at room temperature	
	Load Life		No visual defects	Charge device with twice rated voltage in test chamber set at 85°C \pm 2°C for 1000 hours (+48, -0)
Load Humidity	Capacitance Variation	\leq \pm 30%	Remove from test chamber and stabilize at room temperature for 24 \pm 2 hours before measuring. Store in a test chamber set at 85°C \pm 2°C/ 85% \pm 5% relative humidity for 1000 hours (+48, -0) with rated voltage applied. Remove from chamber and stabilize at room temperature and humidity for 24 \pm 2 hours before measuring.	
	Dissipation Factor	\leq Initial Value x 1.5 (See Above)		
	Insulation Resistance	\geq Initial Value x 0.1 (See Above)		
	Dielectric Strength	Meets Initial Values (As Above)		
	Appearance	No visual defects		

Y5V Dielectric



Capacitance Range

PREFERRED SIZES ARE SHADED

SIZE		0201		0402					0603				0805				1206				1210							
Soldering		Reflow Only		Reflow Only					Reflow/Wave				Reflow/Wave				Reflow/Wave				Reflow/Wave							
Packaging		All Paper		All Paper					All Paper				Paper/Embossed				Paper/Embossed				Paper/Embossed							
(L) Length	MM (in.)	0.60 ± 0.03 (0.024 ± 0.001)		1.00 ± 0.10 (0.040 ± 0.004)					1.60 ± 0.15 (0.063 ± 0.006)				2.01 ± 0.20 (0.079 ± 0.008)				3.20 ± 0.20 (0.126 ± 0.008)				3.20 ± 0.20 (0.126 ± 0.008)							
(W) Width	MM (in.)	0.30 ± 0.03 (0.011 ± 0.001)		0.50 ± 0.10 (0.020 ± 0.004)					.81 ± 0.15 (0.032 ± 0.006)				1.25 ± 0.20 (0.049 ± 0.008)				1.60 ± 0.20 (0.063 ± 0.008)				2.50 ± 0.20 (0.098 ± 0.008)							
(t) Terminal	MM (in.)	0.15 ± 0.05 (0.006 ± 0.002)		0.25 ± 0.15 (0.010 ± 0.006)					0.35 ± 0.15 (0.014 ± 0.006)				0.50 ± 0.25 (0.020 ± 0.010)				0.50 ± 0.25 (0.020 ± 0.010)				.50 ± 0.25 (0.020 ± 0.010)							
WVDC		6.3	10	6.3	10	16	25	50	10	16	25	50	10	16	25	50	10	16	25	50	10	16	25	50	10	16	25	50
Cap (pF)		2200	2700	1000 pF	1000 pF																							
		3300	3900	A	A																							
		4700	A	A	C	C	C	C	C																			
		5600	A	A	C	C	C	C	C																			
		6800	A	A	C	C	C	C	C																			
		8200	A	A	C	C	C	C	C																			
Cap (µF)		0.010	A	A	C	C	C	C	C	G	G	G	G	E	E	E	E											
		0.012	A		C	C	C	C	C	G	G	G	G	E	E	E	E											
		0.015	A		C	C	C	C	C	G	G	G	G	E	E	E	E											
		0.018	A		C	C	C	C	C	G	G	G	G	E	E	E	E											
		0.022	A		C	C	C	C	C	G	G	G	G	E	E	E	E											
		0.027	A		C	C	C	C	C	G	G	G	G	E	E	E	E											
		0.033	A		C	C	C	C		G	G	G	G	E	E	E	E											
		0.039	A		C	C	C	C		G	G	G	G	E	E	E	E											
		0.047	A		C	C	C	C		G	G	G	G	E	E	E	E				J	J	J	J				
		0.056			C	C	C			G	G	G	G	E	E	E	E				J	J	J	J				
		0.068			C	C	C			G	G	G	G	E	E	E	E				J	J	J	J				
		0.082			C	C	C			G	G	G	G	E	E	E	E				J	J	J	J				
		0.10			C	C	C			G	G	G	G	E	E	E	E				J	J	J	J	J	J	J	
		0.12			C	C	C			G	G	G	G	J	J	J	J				J	J	J	J	J	J	J	
		0.15			C	C	C			G	G	G	G	J	J	J	J				J	J	J	J	J	J	J	
		0.18			C	C				G	G	G		J	J	J	J				J	J	J	J	J	J	J	
		0.22			C	C				G	G	G	G	J	J	J	J				J	J	J	J	J	J	J	
		0.27								G	G	G		J	J	J	M				J	J	J	J	J	J	J	
		0.33								G	G			J	J	M	M				J	J	J	J	J	J	J	
		0.39								G	G			J	J	M					J	J	J	J	J	J	J	
		0.47								G	G			J	J	N					J	J	J	J	J	J	J	
		0.56								G	G			J	J	N					J	J	J	J	J	J	J	
		0.68								G	G			J	J	N					J	J	J	J	J	J	J	
		0.82								G	G			M	M	N					J	J	J	J	J	J	J	
		1.0								G	G			N	N	N					J	J	J	J	J	J	J	
		1.2												N	N						J	J	J	J	J	J	M	
		1.5												N	N						M	M	M				M	
		1.8												N	N						M	M	M				J	
		2.2												N	N						M	M	M				J	
		2.7												N	N						M	M	M				J	
		3.3												N							M	M					P	
		3.9												N							P	P					P	
		4.7												N	P						P	P					P	
		5.6																			Q	Q					Q	
		6.8																			Q	Q					Q	
		8.2																			Q	Q					Q	
		10.0																			Q						X	
		12.0																			X							
		15.0																			X							
		18.0																			X							
		22.0																			X							
		47.0																			X							
		100.0																			X							
WVDC		6.3	10	6.3	10	16	25	50	10	16	25	50	10	16	25	50	10	16	25	50	10	16	25	50	10	16	25	50
SIZE		0201		0402					0603				0805				1206				1210							
Letter		A	C	E	G	J	K	M	N	P	Q	X	Y	Z	BB	CC												
Max. Thickness		0.33 (0.013)	0.56 (0.022)	0.71 (0.028)	0.86 (0.034)	0.94 (0.037)	1.02 (0.040)	1.27 (0.050)	1.40 (0.055)	1.52 (0.060)	1.78 (0.070)	2.29 (0.090)	2.54 (0.100)	2.79 (0.110)	3.05 (0.120)	3.175 (0.125)												
		PAPER								EMBOSSSED																		

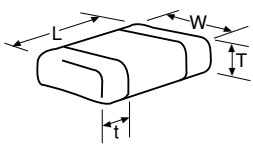

Contact Factory for Multiples



Automotive

GENERAL DESCRIPTION

AVX Corporation has supported the Automotive Industry requirements for Multilayer Ceramic Capacitors consistently for more than 10 years. Products have been developed and tested specifically for automotive applications and all manufacturing facilities are QS9000 and VDA 6.4 approved.

As part of our sustained investment in capacity and state of the art technology, we are now transitioning from the established Pd/Ag electrode system to a Base Metal Electrode system (BME).

AVX is using AECQ200 as the qualification vehicle for this transition. A detailed qualification package is available on request and contains results on a range of part numbers including:

- X7R dielectric components containing BME electrode and copper terminations with a Ni/Sn plated overcoat.
- X7R dielectric components BME electrode and soft terminations with a Ni/Sn plated overcoat.
- NP0 dielectric components containing Pd/Ag electrode and silver termination with a Ni/Sn plated overcoat.

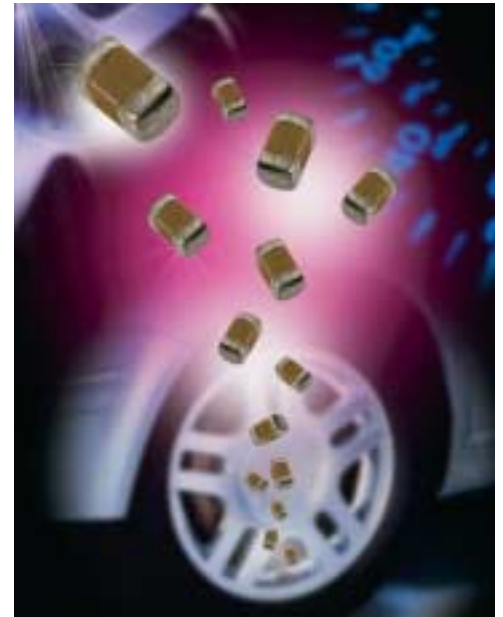

HOW TO ORDER

0805	5	C	104	K	4	T	2	A
Size	Voltage	Dielectric	Capacitance Code (In pF)	Capacitance Tolerance	Failure Rate	Terminations	Packaging	Special Code
0603 0805 1206 1210 1812	6.3V = 6 10V = Z 16V = Y 25V = 3 50V = 5 100V = 1 200V = 2	NP0 = A X7R = C	2 Significant Digits + Number of Zeros e.g. 10µF = 106	J = ±5% K = ±10% M = ±20%	A = Not Applicable 4 = Automotive	T = Plated Ni and Sn Z = Soft Termination U = Conductive Epoxy	1 = 7" Reel Plastic 2 = 7" Reel Paper 3 = 13" Reel Plastic	A = Std. Product

COMMERCIAL VS AUTOMOTIVE MLCC PROCESS COMPARISON

	Commercial	Automotive
Administrative	Standard Part Numbers. No restriction on who purchases these parts.	Specific Automotive Part Number. Used to control supply of product to Automotive customers.
Design	Minimum ceramic thickness of 0.020"	Minimum Ceramic thickness of 0.029" (0.74mm) on all X7R product.
Dicing	Side & End Margins = 0.003" min	Side & End Margins = 0.004" min Cover Layers = 0.005" min
Lot Qualification (Destructive Physical Analysis - DPA)	As per EIA RS469	Increased sample plan – stricter criteria.
Visual/Cosmetic Quality	Standard process and inspection	100% inspection
Application Robustness	Standard sampling for accelerated wave solder on X7R dielectrics	Increased sampling for accelerated wave solder on X7R and NP0 followed by lot by lot reliability testing.

All Tests have Accept/Reject Criteria 0/1

Automotive MLCC



NP0/X7R Dielectric

SOFT TERMINATION FEATURES

a) Bend Test

The capacitor is soldered to the PC Board as shown:

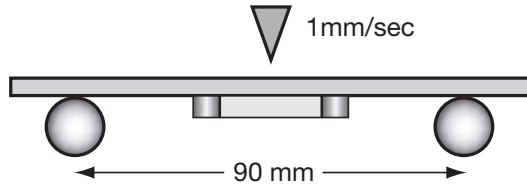

b) Temperature Cycle testing

“Soft Termination” has the ability to withstand at least 1000 cycles between -55°C and $+125^{\circ}\text{C}$

Typical bend test results are shown below:

Style	Conventional Term	Soft Term
0603	>2mm	>5
0805	>2mm	>5
1206	>2mm	>5

ELECTRODE AND TERMINATION OPTIONS

NP0 DIELECTRIC

**NP0 Ag/Pd Electrode
Nickel Barrier Termination
PCB Application**

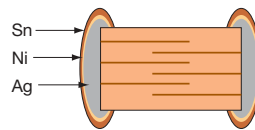

Figure 1 Termination Code T

X7R DIELECTRIC

**X7R Dielectric
PCB Application**

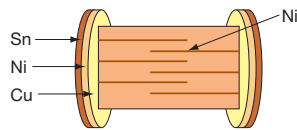

Figure 2 Termination Code T

**X7R Nickel Electrode
Soft Termination
PCB Application**

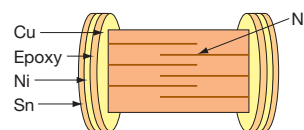

Figure 3 Termination Code Z

**Conductive Epoxy Termination
Hybrid Application**

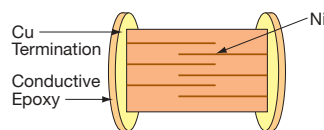



Figure 4 Termination Code U

NP0 Automotive

Capacitance Range (Ni Barrier Termination)



	0603			0805			1206			1210				1812	
	25V	50V	100V	25V	50V	100V	25V	50V	100V	25V	50V	100V	200V	50V	100V
R47															
R51															
R56															
R62															
R68															
R75															
R82															
R91															
1R0															
1R2															
1R5															
1R8															
2R0															
2R2															
2R4															
2R7															
3R0															
3R3															
3R6															
3R9															
4R3															
4R7															
5R1															
5R6															
6R2															
6R8															
7R5															
8R2															
9R1															
100															
120															
150															
180															
220															
270															
330															
390															
470															
510															
560															
680															
820															
101															
121															
151															
181															
221															
271															
331															
391															
471															
561															
681															
821															
102															
122															
152															
182															
222															
272															
332															
392															
472															
562															
682															
822															
103															
	25V	50V	100V	25V	50V	100V	25V	50V	100V	25V	50V	100V	200V	50V	100V
	0603			0805			1206			1210				1812	



 = Paper Tape
 = Plastic Tape

BME X7R Automotive



Capacitance Range (Ni Barrier Termination)

	0603					0805					1206					1210					1812				
	16V	25V	50V	100V	200V	16V	25V	50V	100V	200V	16V	25V	50V	100V	200V	16V	25V	50V	100V	200V	16V	25V	50V	100V	200V
101																									
121																									
151																									
181																									
221																									
271																									
331																									
391																									
471																									
561																									
681																									
821																									
102																									
122																									
152																									
182																									
222																									
272																									
332																									
392																									
472																									
562																									
682																									
822																									
103																									
123																									
153																									
183																									
223																									
273																									
333																									
393																									
473																									
563																									
683																									
823																									
104																									
124																									
154																									
184																									
224																									
274																									
334																									
394																									
474																									
564																									
684																									
824																									
105																									
155																									
	16V	25V	50V	100V	200V	16V	25V	50V	100V	200V	16V	25V	50V	100V	200V	16V	25V	50V	100V	200V	16V	25V	50V	100V	200V

 = Paper Tape
 = Plastic Tape



Capacitor Array

Capacitor Array (IPC)

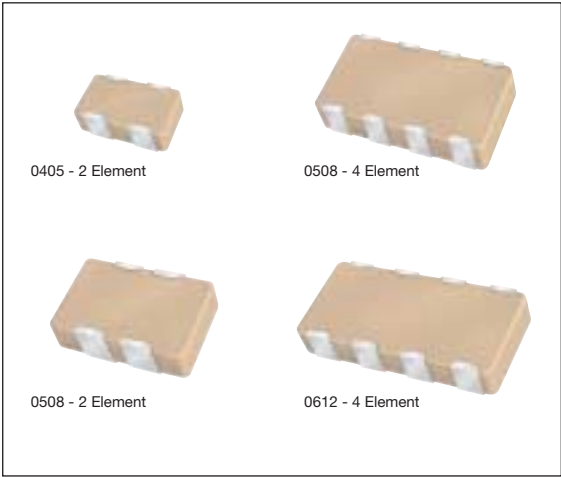

GENERAL DESCRIPTION

AVX is the market leader in the development and manufacture of capacitor arrays. The smallest array option available from AVX the 0405 2-element device, has been an enormous success in the Telecommunications market. The array family of products also includes the 0612 4-element device as well as 0508 2-element and 4-element series, all of which have received widespread acceptance in the marketplace.

AVX capacitor arrays are available in X5R, X7R and NP0 (COG) ceramic dielectrics to cover a broad range of capacitance values. Voltage ratings from 6.3 Volts up to 100 Volts are offered.

Key markets for capacitor arrays are Mobile and Cordless Phones, Digital Set Top Boxes, Computer Motherboards and Peripherals as well as Automotive applications, RF Modems, Networking Products etc.

AVAILABLE CAPACITANCE VALUES

Case Size	Voltage	NP0/COG		X5R/X7R	
		Min. Cap	Max. Cap.	Min. Cap.	Max. Cap.
0612 4 element	10v			124	474
	16v	100	471	221	104
	25v	100	471	221	104
	50v	100	471	221	473
	100v	100	391	221	223
0508 4 element	10v			104	154
	16v	100	271	221	104
	25v	100	271	221	183
	50v	100	271	221	183
	100v	100	221	221	472
0508 2 element	6.3v				105
	16v	100	471	221	104
	25v	100	471	221	333
	50v	100	471	221	333
	100v	100	391	221	682
0405 2 element	10v			273	104
	16v	100	101	121	223
	25v	100	101	121	682
	50v	100	101	121	682

= X5R

HOW TO ORDER

W	2	A	4	3	C	103	M	A	T	2A
Style	Case Size	Array	Number of Caps	Voltage	Dielectric	Capacitance Code (In pF)	Capacitance Tolerance	Failure Rate	Termination Code	Packaging & Quantity Code
	1 = 0405 2 = 0508 3 = 0612			6 = 6.3V Z = 10V Y = 16V 3 = 25V 5 = 50V 1 = 100V	A = NP0 C = X7R D = X5R	2 Sig Digits + Number of Zeros	J = ±5% K = ±10% M = ±20%		T = Plated Ni and Solder	2A = 7" Reel (4000) 4A = 13" Reel (10000) 2F = 7" Reel (1000)



Capacitor Array



Capacitor Array (IPC)

BENEFITS OF USING CAPACITOR ARRAYS

AVX capacitor arrays offer designers the opportunity to lower placement costs, increase assembly line output through lower component count per board and to reduce real estate requirements.

Reduced Costs

Placement costs are greatly reduced by effectively placing one device instead of four or two. This results in increased throughput and translates into savings on machine time. Inventory levels are lowered and further savings are made on solder materials etc.

Space Saving

Space savings can be quite dramatic when compared to the use of discrete chip capacitors. As an example, the 0508 4-element array offers a space reduction of >40% vs. 4 x 0402 discrete capacitors and of >70% vs. 4 x 0603 discrete capacitors. (This calculation is dependent on the spacing of the discrete components.)

Increased Throughput

Assuming that there are 220 passive components placed in a mobile phone:

A reduction in the passive count to 200 (by replacing discrete components with arrays) results in an increase in throughput of approximately. 9%.

A reduction of 40 placements increases throughput by 18%.

For high volume users of cap arrays using the very latest placement equipment capable of placing 10 components per second, the increase in throughput can be very significant and can have the overall effect of reducing the number of placement machines required to mount components:

If 120 million 2-element arrays or 40 million 4-element arrays were placed in a year, the requirement for placement equipment would be reduced by one machine.

During a 20Hr operational day a machine places 720K components. Over a working year of 167 days the machine can place approximately 120 million. If 2-element arrays are mounted instead of discrete components, then the number of placements is reduced by a factor of two and in the scenario where 120 million 2-element arrays are placed there is a saving of one pick and place machine.

Smaller volume users can also benefit from replacing discrete components with arrays. The total number of placements is reduced thus creating spare capacity on placement machines. This in turn generates the opportunity to increase overall production output without further investment in new equipment.

W2A (0508) Capacitor Arrays

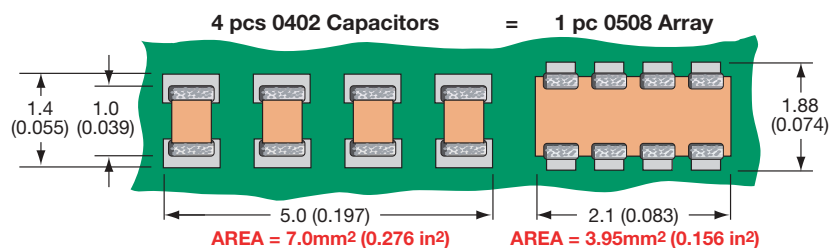

The 0508 4-element capacitor array gives a PCB space saving of over 40% vs four 0402 discrettes and over 70% vs four 0603 discrete capacitors.

W3A (0612) Capacitor Arrays

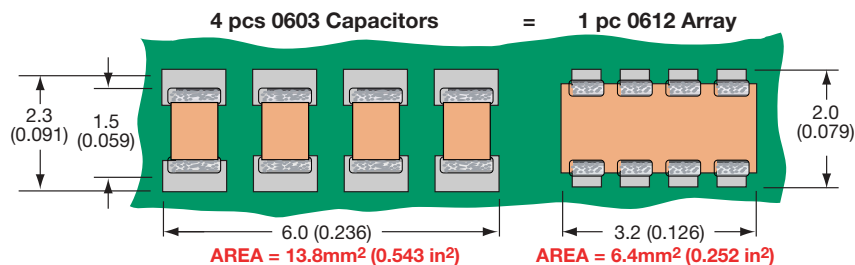

The 0612 4-element capacitor array gives a PCB space saving of over 50% vs four 0603 discrettes and over 70% vs four 0805 discrete capacitors.



Capacitor Array

Multi-Value Capacitor Array (IPC)

GENERAL DESCRIPTION

A recent addition to the array product range is the Multi-Value Capacitor Array. These devices combine two different capacitance values in standard 'Cap Array' packages and are available with a maximum ratio between the two capacitance values of 100:1. The multi-value array is currently available in the 0405 and 0508 2-element styles.

Whereas to date AVX capacitor arrays have been suited to applications where multiple capacitors of the same value are used, the multi-value array introduces a new flexibility to the range. The multi-value array can replace discrete capacitors of different values and can be used for broadband decoupling applications. The 0508 x 2 element multi-value array would be particularly recommended in this application. Another application is filtering the 900/1800 or 1900MHz noise in mobile phones. The 0405 2-element, low capacitance value NP0, (C0G) device would be suited to this application, in view of the space saving requirements of mobile phone manufacturers.

ADVANTAGES OF THE MULTI-VALUE CAPACITOR ARRAYS

Enhanced Performance Due to Reduced Parasitic Inductance

When connected in parallel, not only do discrete capacitors of different values give the desired self-resonance, but an additional unwanted parallel resonance also results. This parallel resonance is induced between each capacitor's self-resonant frequencies and produces a peak in impedance response. For decoupling and bypassing applications this peak will result in a frequency band of reduced decoupling and in filtering applications reduced attenuation.

The multi-value capacitor array, combining capacitors in one unit, virtually eliminates the problematic parallel resonance, by minimizing parasitic inductance between the capacitors, thus enhancing the broadband decoupling/filtering performance of the part.

Reduced ESR

An advantage of connecting two capacitors in parallel is a significant reduction in ESR. However, as stated above, using discrete components brings with it the unwanted side effect of parallel resonance. The multi-value cap array is an excellent alternative as not only does it perform the same function as parallel capacitors but also it reduces the uncertainty of the frequency response.

HOW TO ORDER

W	2	A	2	Y	C	102M	104M	A	T	2A
Style	Case Size	Array	Number of Caps	Voltage	Dielectric	1st Value	2nd Value	Failure Rate	Termination Code	Packaging & Quantity Code
	1 = 0405 2 = 0508			6 = 6.3V Z = 10V Y = 16V 3 = 25V 5 = 50V 1 = 100V	A = NP0 C = X7R D = X5R	Capacitance Code (In pF) 2 Sig. Digits + Number of Zeros	Capacitance Tolerance K = ±10% M = ±20%		T = Plated Ni and Sn	2A = 7" Reel (4000) 4A = 13" Reel (10000) 2F = 7" Reel (1000)

IMPEDANCE vs FREQUENCY MULTI-VALUE ARRAY COMPARED TO DISCRETE CAPACITORS

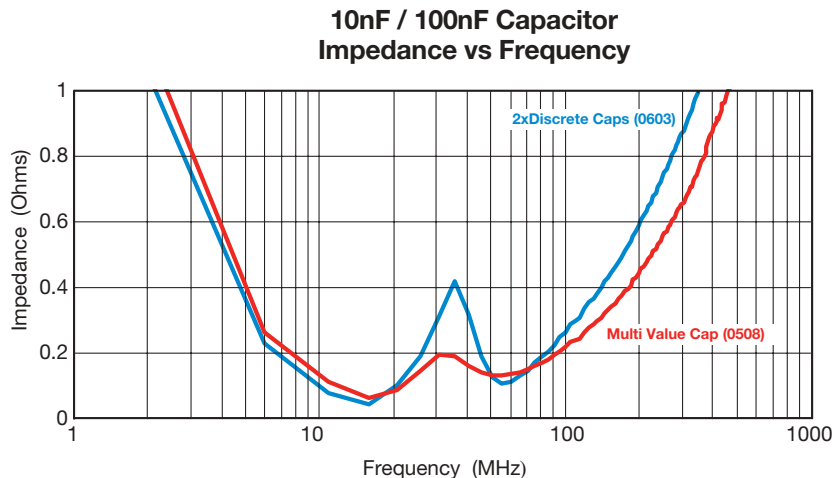

PART & PAD LAYOUT DIMENSIONS

millimeters (inches)

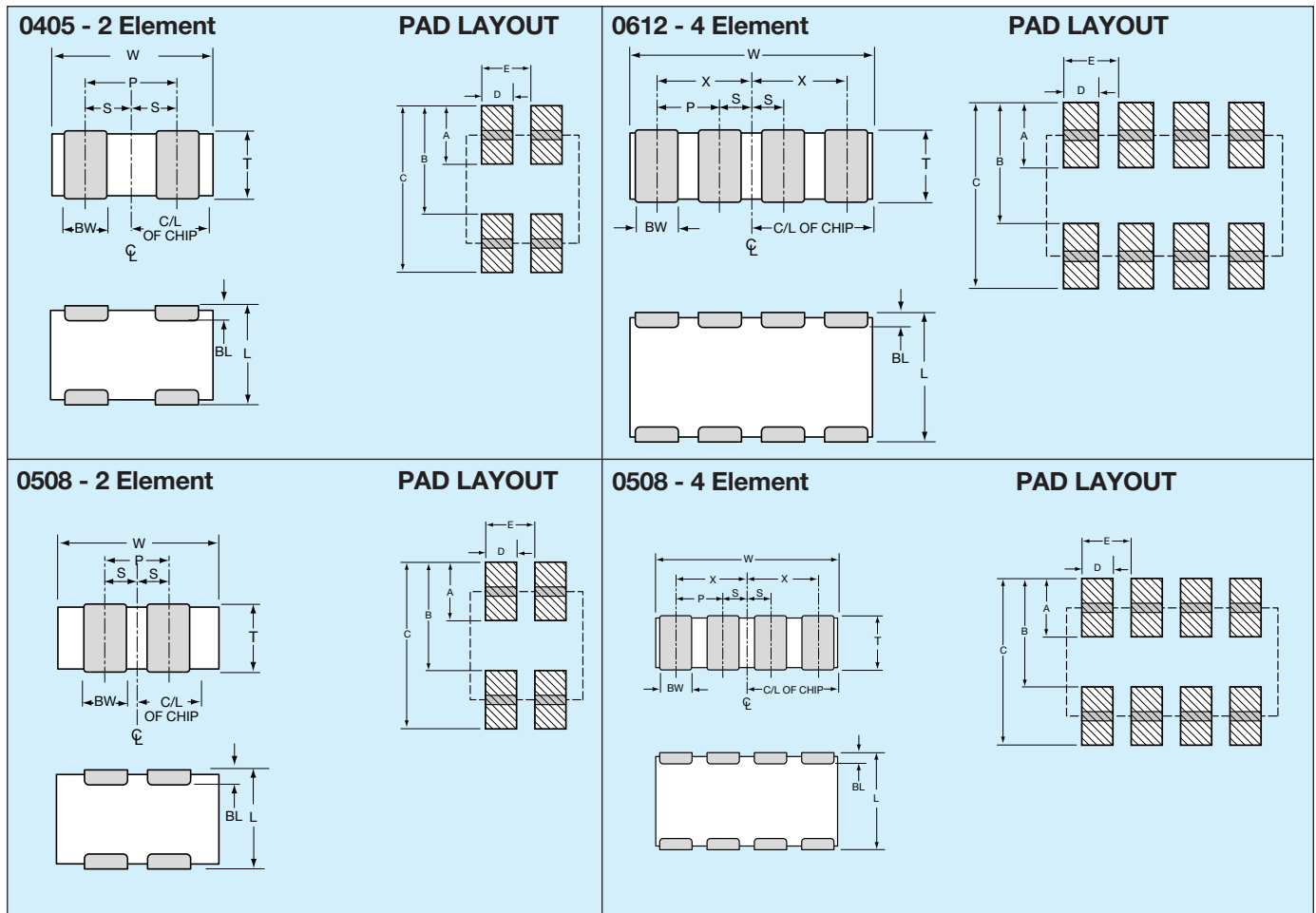

PART DIMENSIONS

0405 - 2 Element

L	W	T	BW	BL	P	S
1.00 ± 0.15 (0.039 ± 0.006)	1.37 ± 0.15 (0.054 ± 0.006)	0.66 MAX (0.026 MAX)	0.36 ± 0.10 (0.014 ± 0.004)	0.20 ± 0.10 (0.008 ± 0.004)	0.64 REF (0.025 REF)	0.32 ± 0.10 (0.013 ± 0.004)

0508 - 2 Element

L	W	T	BW	BL	P	S
1.30 ± 0.15 (0.051 ± 0.006)	2.10 ± 0.15 (0.083 ± 0.006)	0.94 MAX (0.037 MAX)	0.43 ± 0.10 (0.017 ± 0.004)	0.33 ± 0.08 (0.013 ± 0.003)	1.00 REF (0.039 REF)	0.50 ± 0.10 (0.020 ± 0.004)

0508 - 4 Element

L	W	T	BW	BL	P	X	S
1.30 ± 0.15 (0.051 ± 0.006)	2.10 ± 0.15 (0.083 ± 0.006)	0.94 MAX (0.037 MAX)	0.25 ± 0.06 (0.010 ± 0.003)	0.20 ± 0.08 (0.008 ± 0.003)	0.50 REF (0.020 REF)	0.75 ± 0.10 (0.030 ± 0.004)	0.25 ± 0.10 (0.010 ± 0.004)

0612 - 4 Element

L	W	T	BW	BL	P	X	S
1.60 ± 0.20 (0.063 ± 0.008)	3.20 ± 0.20 (0.126 ± 0.008)	1.35 MAX (0.053 MAX)	0.41 ± 0.10 (0.016 ± 0.004)	0.18 ± 0.08 (0.007 ± 0.003)	0.76 REF (0.030 REF)	1.14 ± 0.10 (0.045 ± 0.004)	0.38 ± 0.10 (0.015 ± 0.004)

PAD LAYOUT DIMENSIONS

0405 - 2 Element

A	B	C	D	E
0.46 (0.018)	0.74 (0.029)	1.20 (0.047)	0.30 (0.012)	0.64 (0.025)

0508 - 2 Element

A	B	C	D	E
0.68 (0.027)	1.32 (0.052)	2.00 (0.079)	0.46 (0.018)	1.00 (0.039)

0508 - 4 Element

A	B	C	D	E
0.56 (0.022)	1.32 (0.052)	1.88 (0.074)	0.30 (0.012)	0.50 (0.020)

0612 - 4 Element

A	B	C	D	E
0.89 (0.035)	1.65 (0.065)	2.54 (0.100)	0.46 (0.018)	0.79 (0.031)

Low Inductance Capacitors

Introduction

As switching speeds increase and pulse rise times decrease the need to reduce inductance becomes a serious limitation for improved system performance. Even the decoupling capacitors, that act as a local energy source, can generate unacceptable voltage spikes: $V = L (di/dt)$. Thus, in high speed circuits, where di/dt can be quite large, the size of the voltage spike can only be reduced by reducing L.

Figure 1 displays the evolution of ceramic capacitor toward lower inductance designs over the last few years. AVX has been at the forefront in the design and manufacture of these newer more effective capacitors.

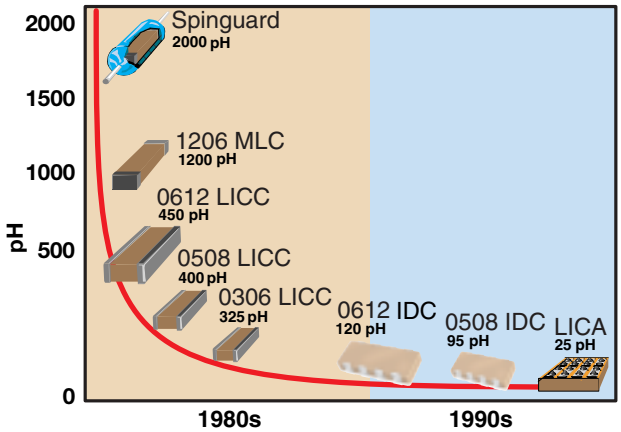

Figure 1. The evolution of Low Inductance Capacitors at AVX (values given for a 100 nF capacitor of each style)

LOW INDUCTANCE CHIP CAPACITORS

The total inductance of a chip capacitor is determined both by its length to width ratio and by the mutual inductance coupling between its electrodes. Thus a 1210 chip size has lower inductance than a 1206 chip. This design improvement is the basis of AVX's low inductance chip capacitors, LI Caps, where the electrodes are terminated on the long side of the chip instead of the short side. The 1206 becomes an 0612 as demonstrated in Figure 2. In the same manner, an 0805 becomes an 0508 and 0603 becomes an 0306. This results in a reduction in inductance from around 1200 pH for conventional MLC chips to below 400 pH for Low Inductance Chip Capacitors. Standard designs and performance of these LI Caps are given on pages 33 and 34.

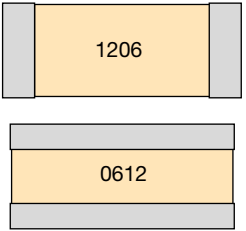
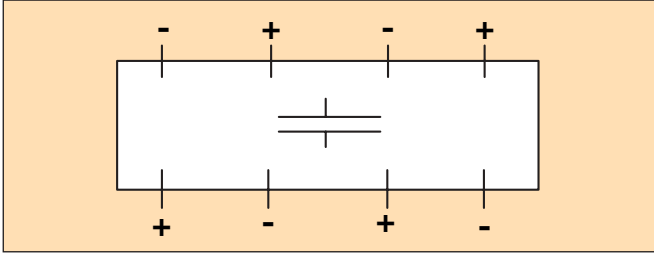

Figure 2. Change in aspect ratio: 1206 vs. 0612

INTERDIGITATED CAPACITORS

Multiple terminations of a capacitor will also help in reducing the parasitic inductance of the device. The IDC is such a device. By terminating one capacitor with 8 connections the ESL can be reduced even further. The measured inductance of the 0612 IDC is 120 pH, while the 0508 comes in around 95 pH. These FR4 mountable devices allow for even higher clock speeds in a digital decoupling scheme. Design and product offerings are shown on pages 35 and 36.



LOW INDUCTANCE CHIP ARRAYS (LICA®)

Further reduction in inductance can be achieved by designing alternative current paths to minimize the mutual inductance factor of the electrodes (Figure 3). This is achieved by AVX's LICA® product which was the result of a joint development between AVX and IBM. As shown in Figure 4, the charging current flowing out of the positive plate returns in the opposite direction along adjacent negative plates. This minimizes the mutual inductance.

The very low inductance of the LICA capacitor stems from the short aspect ratio of the electrodes, the arrangement of the tabs so as to cancel inductance, and the vertical aspect of the electrodes to the mounting surface.

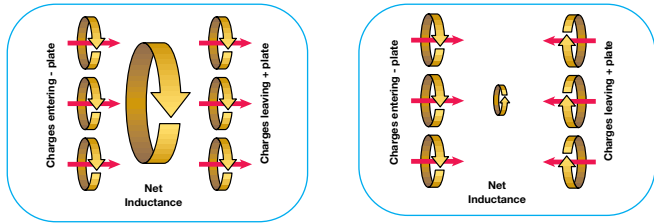

Figure 3. Net Inductance from design. In the standard Multilayer capacitor, the charge currents entering and leaving the capacitor create complementary flux fields, so the net inductance is greater. On the right, however, if the design permits the currents to be opposed, there is a net cancellation, and the inductance is much lower.

Low Inductance Capacitors



Introduction

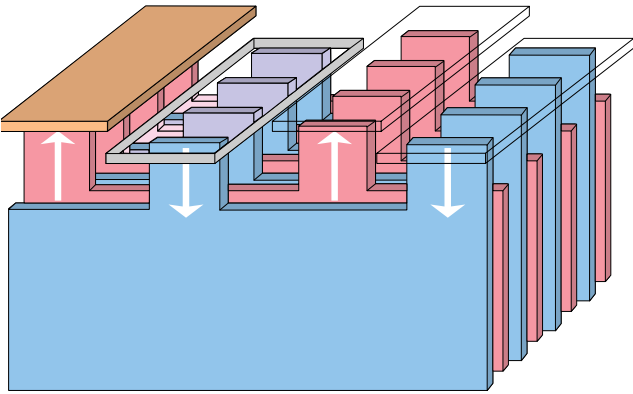

Figure 4. LICA's Electrode/Termination Construction. The current path is minimized – this reduces self-inductance. Current flowing out of the positive plate, returns in the opposite direction along the adjacent negative plate – this reduces the mutual inductance.

Also the effective current path length is minimized because the current does not have to travel the entire length of both electrodes to complete the circuit. This reduces the self inductance of the electrodes. The self inductance is also minimized by the fact that the charging current is supplied by both sets of terminals reducing the path length even further!

The inductance of this arrangement is less than 50 pH, causing the self-resonance to be above 100 MHz for the same popular 100 nF capacitance. Parts available in the LICA design are shown on pages 37 and 38.

Figure 5 compares the self resonant frequencies of various capacitor designs versus capacitance values. The approximate inductance of each style is also shown.

Active development continues on low inductance capacitors. C4 termination with low temperature solder is now available for plastic packages. Consult AVX for details.

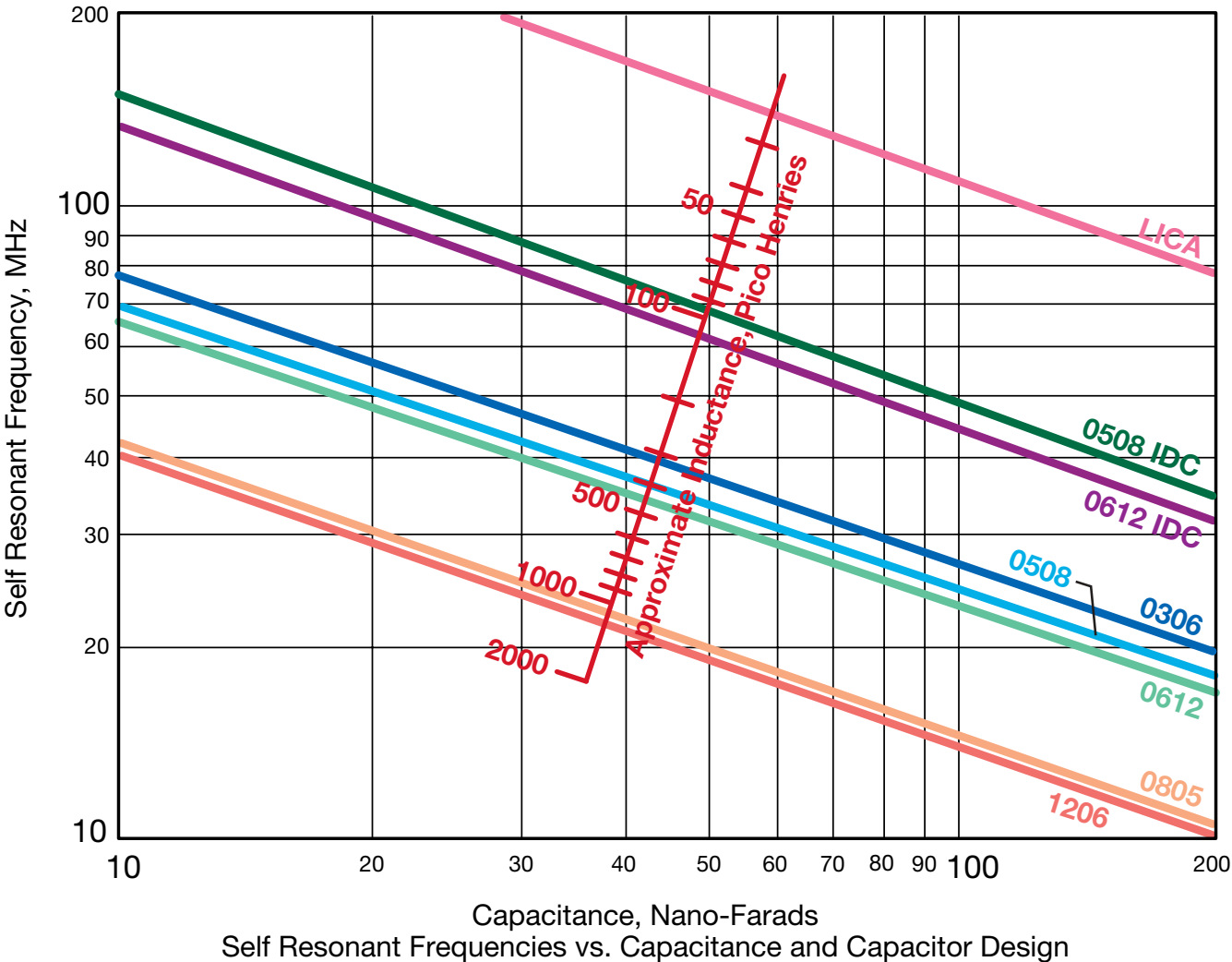

Figure 5



Low Inductance Capacitors



0612/0508/0306 LICC (Low Inductance Chip Capacitors)

GENERAL DESCRIPTION

The total inductance of a chip capacitor is determined both by its length to width ratio and by the mutual inductance coupling between its electrodes.

Thus a 1210 chip size has a lower inductance than a 1206 chip. This design improvement is the basis of AVX's Low Inductance Chip Capacitors (LICC), where the electrodes are terminated on the long side of the chip instead of the short side. The 1206 becomes an 0612, in the same manner, an 0805 becomes an 0508, an 0603 becomes an 0306. This results in a reduction in inductance from the 1nH range found in normal chip capacitors to less than 0.4nH for LICCs. Their low profile is also ideal for surface mounting (both on the PCB and on IC package) or inside cavity mounting on the IC itself.

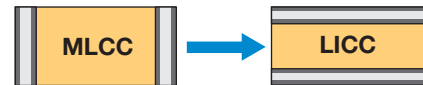
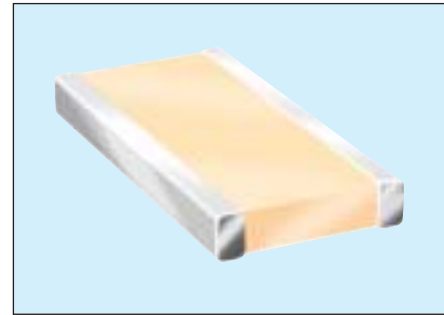

HOW TO ORDER

0612

Size
0306
0508
0612

Z

Voltage
6 = 6.3V
Z = 10V
Y = 16V
3 = 25V

D

Dielectric
C = X7R
D = X5R

105

Capacitance Code (In pF)
2 Sig. Digits + Number of Zeros

M

Capacitance Tolerance
K = $\pm 10\%$
M = $\pm 20\%$

A

Failure Rate
A = N/A

T

Terminations
T = Plated Ni and Sn

2

Packaging Available
2 = 7" Reel
4 = 13" Reel

A*

Thickness
Thickness
mm (in)
0.56 (0.022)
0.61 (0.024)
0.76 (0.030)
1.02 (0.040)
1.27 (0.050)

PERFORMANCE CHARACTERISTICS

Capacitance Tolerances	K = $\pm 10\%$; M = $\pm 20\%$
Operation Temperature Range	X7R = -55°C to +125°C; X5R = -55°C to +85°C
Temperature Coefficient	$\pm 15\%$ (0VDC)
Voltage Ratings	6.3, 10, 16, 25 VDC
Dissipation Factor	6.3V = 6.5% max; 10V = 5.0% max; 16V = 3.5% max; 25V = 3.0% max
Insulation Resistance (@+25°C, RVDC)	100,000M Ω min, or 1,000M Ω per μ F min., whichever is less

TYPICAL INDUCTANCE

Package Style	Measured Inductance (pH)
1206 MLCC	1200
0612 LICC	450
0508 LICC	400
0306 LICC	325

*Note: See Range Chart for Codes

TYPICAL IMPEDANCE CHARACTERISTICS

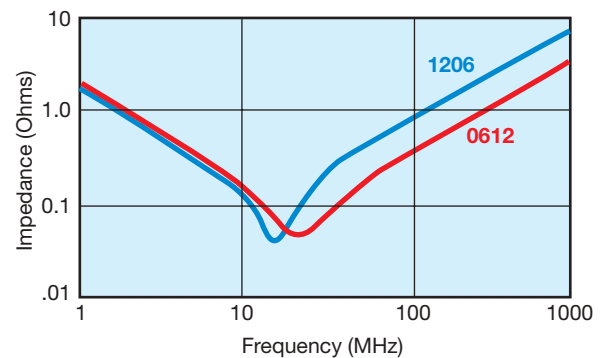
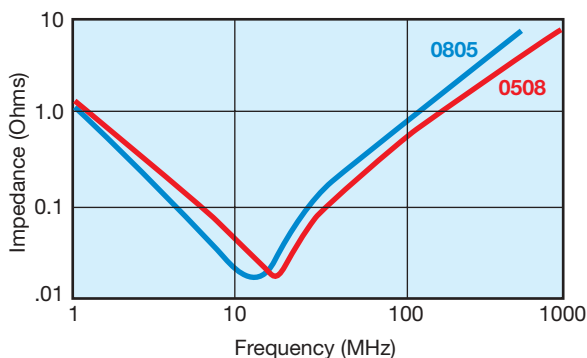

Low Inductance Capacitors

0612/0508 IDC (InterDigitated Capacitors)



GENERAL DESCRIPTION

- Very low equivalent series inductance (ESL), surface mountable, high speed decoupling capacitor in 0612 and 0508 case size.
- Measured inductances of 120 pH (for 0612) and 95 pH (for 0508) are the lowest in the FR4 mountable device family.
- Opposing current flow creates opposing magnetic fields. This causes the fields to cancel, effectively reducing the equivalent series inductance.
- Perfect solution for decoupling high speed microprocessors by allowing the engineers to lower the power delivery inductance of the entire system through the use of eight vias.
- Overall reduction in decoupling components due to very low series inductance and high capacitance.

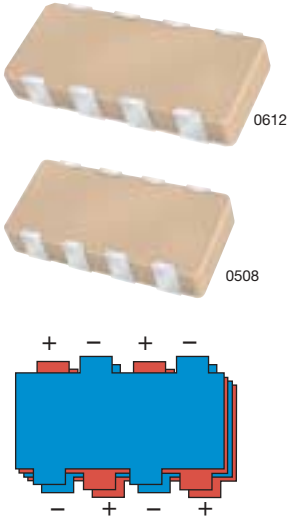

HOW TO ORDER

W	3	L	1	6	D	225	M	A	T	3	A
Style	Case Size	Low Inductance	Number of Caps	Voltage	Dielectric	Capacitance Code (In pF)	Capacitance Tolerance	Failure Rate	Termination	Packaging Available	Thickness
	2 = 0508 3 = 0612	ESL = 95pH ESL = 120pH		4 = 4V 6 = 6.3V Z = 10V Y = 16V	C = X7R D = X5R	2 Sig. Digits + Number of Zeros	M = ±20% (Preferred) K = ±10%	A = N/A	T = Plated Ni and Sn	1=7" Reel 3=13" Reel	Max. Thickness mm (in.) A=0.95 (0.037) S=0.55 (0.022)

PERFORMANCE CHARACTERISTICS

Capacitance Tolerance	±20% Preferred (10% Available)
Operation Temperature Range	X7R = -55°C to +125°C; X5R = -55°C to +85°C
Temperature Coefficient	±15% (0VDC)
Voltage Ratings	4, 6.3, 10, 16 VDC
Dissipation Factor	4V, 6.3V = 6.5% max; 10V = 5.0% max; 16V = 3.5% max
Insulation Resistance (@+25°C, RVDC)	100,000MΩ min, or 1,000MΩ per μF min., whichever is less

Dielectric Strength	No problems observed after 2.5 x RVDC for 5 seconds at 50mA max current
CTE (ppm/C)	12.0
Thermal Conductivity	4-5W/M K
Terminations Available	Plated Nickel and Solder
Max. Thickness	0.037" (0.95mm)

TYPICAL ESL AND IMPEDANCE

Package Style	Measured Inductance (pH)
1206 MLCC	1200
0612 LICC	450
0612 IDC	120
0508 IDC	95

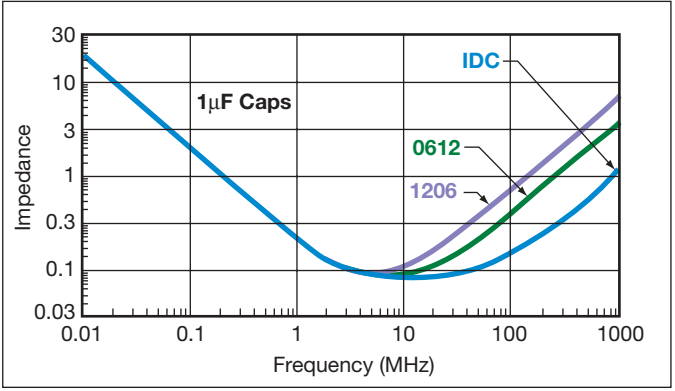

Low Inductance Capacitors

0612/0508 IDC (InterDigitated Capacitors)



SIZE	Thin 0508				0508				Thin 0612				0612																																																																																																																																																																																																										
Length	MM (in.)	2.03 ± 0.20 (0.080 ± 0.008)				2.03 ± 0.20 (0.080 ± 0.008)				3.20 ± 0.20 (0.126 ± 0.008)				3.20 ± 0.20 (0.126 ± 0.008)																																																																																																																																																																																																									
Width	MM (in.)	1.27 ± 0.20 (0.050 ± 0.008)				1.27 ± 0.20 (0.050 ± 0.008)				1.60 ± 0.20 (0.063 ± 0.008)				1.60 ± 0.20 (0.063 ± 0.008)																																																																																																																																																																																																									
Terminal Pitch	MM (in.)	0.508 REF 0.020 REF				0.508 REF 0.020 REF				0.76 REF 0.030 REF				0.76 REF 0.030 REF																																																																																																																																																																																																									
Thickness	MM (in.)	0.55 MAX. (0.022) MAX.				0.95 MAX. (0.037) MAX.				0.55 MAX. (0.022) MAX.				0.95 MAX. (0.037) MAX.																																																																																																																																																																																																									
Inductance (pH)		95				95				120				120																																																																																																																																																																																																									
WVDC		4	6.3	10	16	4	6.3	10	16	4	6.3	10	16	4	6.3	10	16																																																																																																																																																																																																						
CAP (uF) and Thickness		<table border="1"> <tr><td>0.047</td><td></td><td></td><td></td><td></td><td></td><td></td><td></td><td></td><td></td><td></td><td></td><td></td><td></td><td></td><td></td><td></td><td></td></tr> <tr><td>0.068</td><td></td><td></td><td></td><td></td><td></td><td></td><td></td><td></td><td></td><td></td><td></td><td></td><td></td><td></td><td></td><td></td><td></td></tr> <tr><td>0.10</td><td></td><td></td><td></td><td></td><td></td><td></td><td></td><td></td><td></td><td></td><td></td><td></td><td></td><td></td><td></td><td></td><td></td></tr> <tr><td>0.22</td><td></td><td></td><td></td><td></td><td></td><td></td><td></td><td></td><td></td><td></td><td></td><td></td><td></td><td></td><td></td><td></td><td></td></tr> <tr><td>0.33</td><td></td><td></td><td></td><td></td><td></td><td></td><td></td><td></td><td></td><td></td><td></td><td></td><td></td><td></td><td></td><td></td><td></td></tr> <tr><td>0.47</td><td></td><td></td><td></td><td></td><td></td><td></td><td></td><td></td><td></td><td></td><td></td><td></td><td></td><td></td><td></td><td></td><td></td></tr> <tr><td>0.68</td><td></td><td></td><td></td><td></td><td></td><td></td><td></td><td></td><td></td><td></td><td></td><td></td><td></td><td></td><td></td><td></td><td></td></tr> <tr><td>1.0</td><td></td><td></td><td></td><td></td><td></td><td></td><td></td><td></td><td></td><td></td><td></td><td></td><td></td><td></td><td></td><td></td><td></td></tr> <tr><td>1.5</td><td></td><td></td><td></td><td></td><td></td><td></td><td></td><td></td><td></td><td></td><td></td><td></td><td></td><td></td><td></td><td></td><td></td></tr> <tr><td>2.2</td><td></td><td></td><td></td><td></td><td></td><td></td><td></td><td></td><td></td><td></td><td></td><td></td><td></td><td></td><td></td><td></td><td></td></tr> <tr><td>3.3</td><td></td><td></td><td></td><td></td><td></td><td></td><td></td><td></td><td></td><td></td><td></td><td></td><td></td><td></td><td></td><td></td><td></td></tr> </table>																0.047																		0.068																		0.10																		0.22																		0.33																		0.47																		0.68																		1.0																		1.5																		2.2																		3.3																	
0.047																																																																																																																																																																																																																							
0.068																																																																																																																																																																																																																							
0.10																																																																																																																																																																																																																							
0.22																																																																																																																																																																																																																							
0.33																																																																																																																																																																																																																							
0.47																																																																																																																																																																																																																							
0.68																																																																																																																																																																																																																							
1.0																																																																																																																																																																																																																							
1.5																																																																																																																																																																																																																							
2.2																																																																																																																																																																																																																							
3.3																																																																																																																																																																																																																							

Consult factory for additional requirements

- = X7R
- = X5R

PHYSICAL DIMENSIONS AND PAD LAYOUT

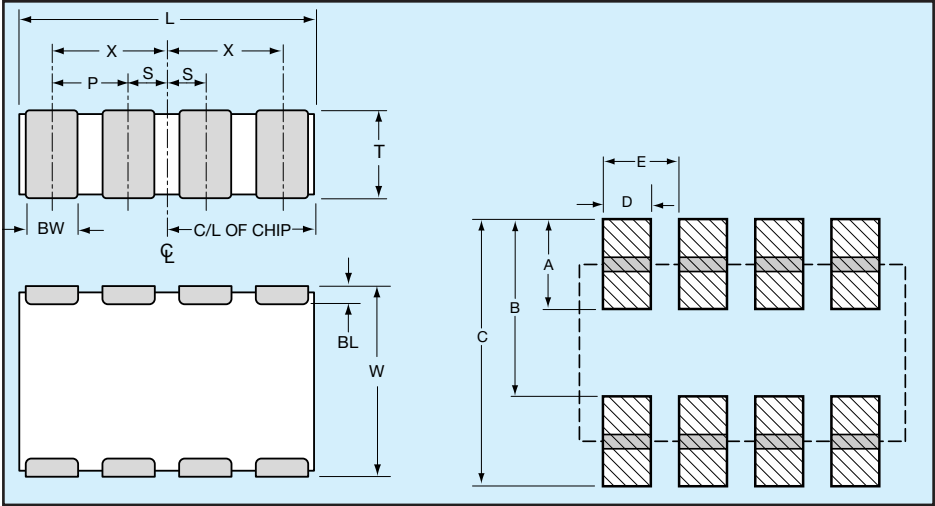

PHYSICAL CHIP DIMENSIONS millimeters (inches)

0612

L	W	BW	BL	P	X	S
3.20 ± 0.20 (0.126 ± 0.008)	1.60 ± 0.20 (0.063 ± 0.008)	0.41 ± 0.10 (0.016 ± 0.004)	0.18 ^{+0.25} _{-0.08} (0.007 ^{+0.010} _{-0.003})	0.76 REF (0.030 REF)	1.14 ± 0.10 (0.045 ± 0.004)	0.38 ± 0.10 (0.015 ± 0.004)

0508

L	W	BW	BL	P	X	S
2.03 ± 0.20 (0.080 ± 0.008)	1.27 ± 0.20 (0.050 ± 0.008)	0.254 ± 0.10 (0.010 ± 0.004)	0.18 ^{+0.25} _{-0.08} (0.007 ^{+0.010} _{-0.003})	0.508 REF (0.020 REF)	0.76 ± 0.10 (0.030 ± 0.004)	0.254 ± 0.10 (0.010 ± 0.004)

PAD LAYOUT DIMENSIONS

0612

A	B	C	D	E
0.89 (0.035)	1.65 (0.065)	2.54 (0.100)	0.46 (0.018)	0.76 (0.030)

0508

A	B	C	D	E
0.64 (0.025)	1.27 (0.050)	1.91 (0.075)	0.28 (0.011)	0.51 (0.020)



Low Inductance Capacitors



LICA® (Low Inductance Decoupling Capacitor Arrays)



LICA® arrays utilize up to four separate capacitor sections in one ceramic body (see Configurations and Capacitance Options). These designs exhibit a number of technical advancements:

Low Inductance features—

- Low resistance platinum electrodes in a low aspect ratio pattern
- Double electrode pickup and perpendicular current paths
- C4 “flip-chip” technology for minimal interconnect inductance

HOW TO ORDER

LICA	3	T	102	M	3	F	C	4	A	A
Style & Size	5V = 9 25V = 3 50V = 5	D = X5R T = T55T S = High K T55T	Cap/Section (EIA Code) 102 = 1000 pF 103 = 10 nF 104 = 100 nF	Capacitance Tolerance M = ±20% P = GMV	Height Code 6 = 0.500mm 3 = 0.650mm 1 = 0.875mm 5 = 1.100mm 7 = 1.600mm	Termination F = C4 Solder Balls- 97Pb/3Sn P = Cr-Cu-Au N = Cr-Ni-Au X = None	Reel Packaging M = 7" Reel R = 13" Reel 6 = 2"x2" Waffle Pack 8 = 2"x2" Black Waffle Pack 7 = 2"x2" Waffle Pack w/ termination facing up A = 2"x2" Black Waffle Pack w/ termination facing up C = 4"x4" Waffle Pack w/ clear lid	# of Caps/Part 1 = one 2 = two 4 = four	Inspection Code A = Standard B = Established Reliability Testing	Code Face A = Bar B = No Bar C = Dot, S55S Dielectrics

TABLE 1

Typical Parameters	T55T	Units
Capacitance, 25°C	Co	Nanofarads
Capacitance, 55°C	1.4 x Co	Nanofarads
Capacitance, 85°C	Co	Nanofarads
Dissipation Factor 25°	12	Percent
DC Resistance	0.2	Ohms
IR (Minimum @25°)	2.0	Megaohms
Dielectric Breakdown, Min	500	Volts
Thermal Coefficient of Expansion	8.5	ppm/°C 25-100°
Inductance: (Design Dependent)	15 to 120	Pico-Henries
Frequency of Operation	DC to 5 Gigahertz	
Ambient Temp Range	-55° to 125°C	

C4 AND PAD DIMENSIONS

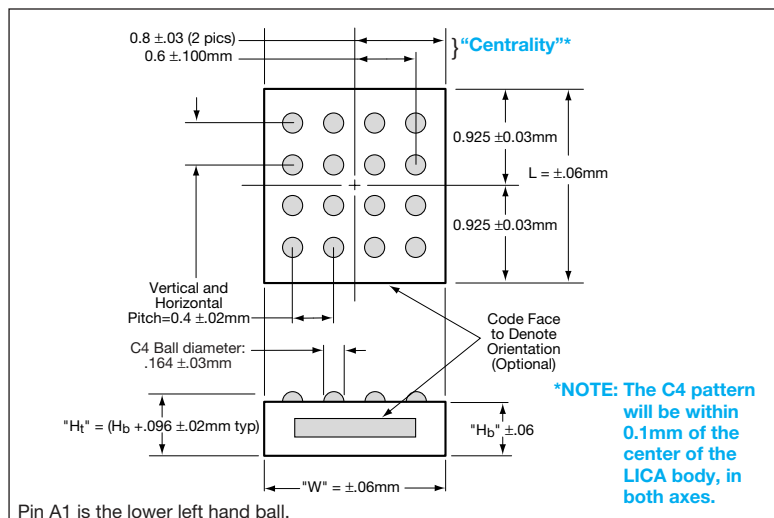

Code (Body Height)	Width (W)	Length (L)	Height Body (H _b)
1	1.600mm	1.850mm	0.875mm
3	1.600mm	1.850mm	0.650mm
5	1.600mm	1.850mm	1.100mm
6	1.600mm	1.850mm	0.500mm
7	1.600mm	1.850mm	1.600mm

TERMINATION OPTIONS

C4 SOLDER (97% Pb/3% Sn) BALLS



TERMINATION OPTION P OR N



Low Inductance Capacitors



LICA® (Low Inductance Decoupling Capacitor Arrays)

LICA® TYPICAL PERFORMANCE CURVES

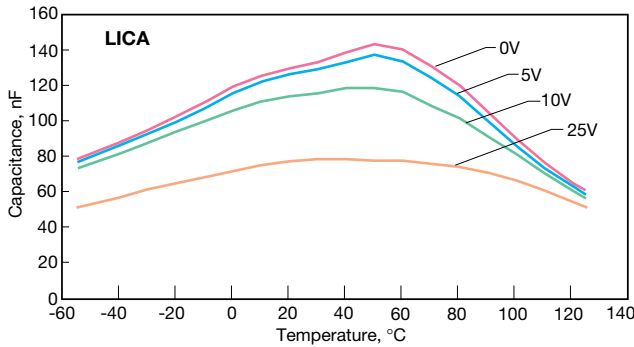

Effect of Bias Voltage and Temperature on a 130 nF LICA® (T55T)

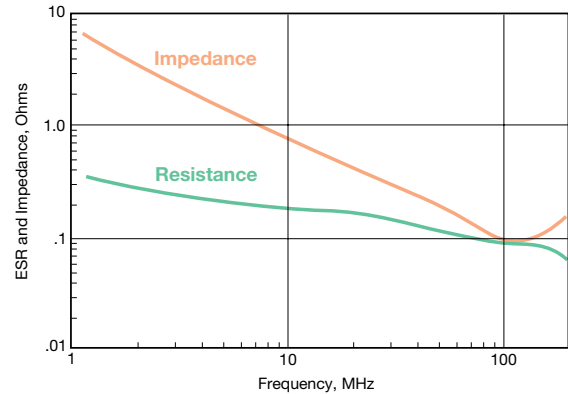

Impedance vs. Frequency

LICA VALID PART NUMBER LIST

Part Number	Voltage	Thickness (mm)	Capacitors per Package
LICA3T183M3FC4AA	25	0.650	4
LICA3T143P3FC4AA	25	0.650	4
LICA3T134M1FC1AA	25	0.875	1
LICA3T104P1FC1AA	25	0.875	1
LICA3T253M1FC4AA	25	0.875	4
LICA3T203P1FC4AA	25	0.875	4
LICA3T204M5FC1AA	25	1.100	1
LICA3T164P5FC1AA	25	1.100	1
LICA3T304M7FC1AB	25	1.600	1
LICA3T244P7FC1AB	25	1.600	1
LICA5T802M1FC4AB	50	0.875	4
LICA5T602P1FC4AB	50	0.875	4
Extended Range			
LICA9D683M6FC4AB	5	0.500	4
LICA3T104M3FC1A	25	0.650	1
LICA3T803P3FC1A	25	0.650	1
LICA3T503M3FC2A	25	0.650	2
LICA3T403P3FC2A	25	0.650	2
LICA3S213M3FC4A	25	0.650	4

CONFIGURATION

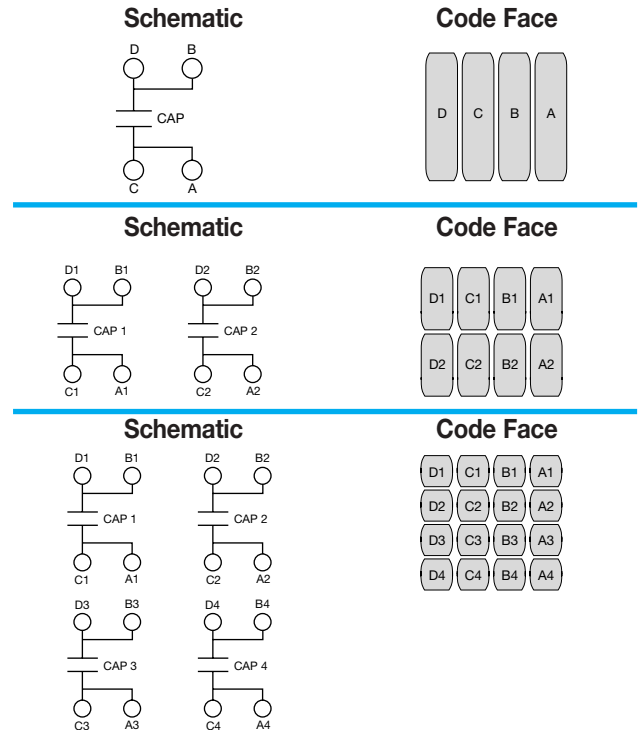

WAFFLE PACK OPTIONS FOR LICA®

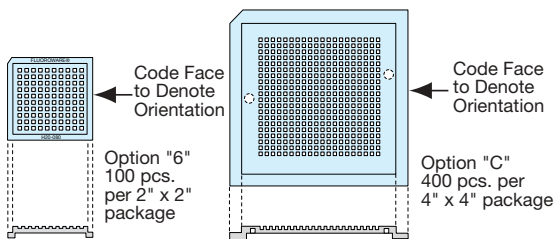

Note: Standard configuration is Termination side down

LICA® PACKAGING SCHEME "M" AND "R"

8mm conductive plastic tape on reel:
 "M"=7" reel max. qty. 3,000, "R"=13" reel max. qty. 8,000

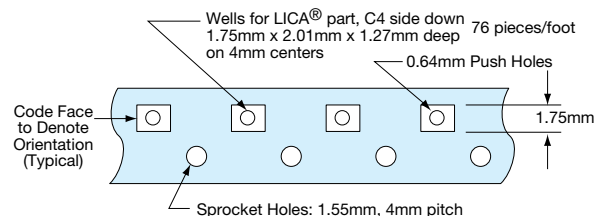

High Voltage Chips



For 500V to 5000V Applications

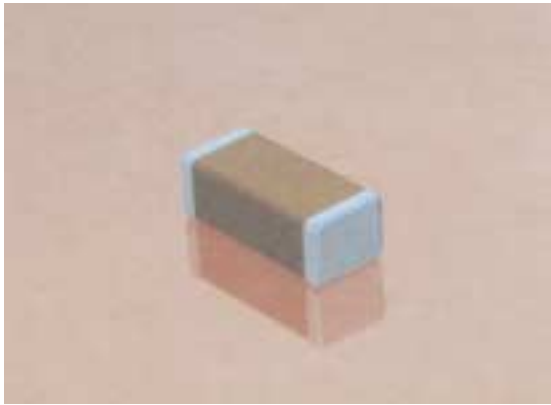

High value, low leakage and small size are difficult parameters to obtain in capacitors for high voltage systems. AVX special high voltage MLC chips capacitors meet these performance characteristics and are designed for applications such as snubbers in high frequency power converters, resonators in SMPS, and high voltage coupling/DC blocking. These high voltage chip designs exhibit low ESRs at high frequencies.

Larger physical sizes than normally encountered chips are used to make high voltage chips. These larger sizes require that special precautions be taken in applying these chips in surface mount assemblies. This is due to differences in the coefficient of thermal expansion (CTE) between the substrate materials and chip capacitors. Apply heat at less than 4°C per second during the preheat. Maximum preheat temperature must be within 50°C of the soldering temperature. The solder temperature should not exceed 230°C. Chips 1808 and larger to use reflow soldering only.

Capacitors with X7R Dielectrics are not intended for AC line filtering applications.

Contact plant for recommendations. Capacitors may require protective surface coating to prevent external arcing.

PART NUMBER (see page 2 for complete information and options)

1808



AVX Style
1206
1210
1808
1812
1825
2220
2225
3640

A



Voltage
7 = 500V
C = 600V
A = 1000V
S = 1500V
G = 2000V
W = 2500V
H = 3000V
J = 4000V
K = 5000V

A



Temperature Coefficient
A = C0G
C = X7R

271



Capacitance Code
(2 significant digits + no. of zeros)
Examples:
10 pF = 100
100 pF = 101
1,000 pF = 102
22,000 pF = 223
220,000 pF = 224
1 μF = 105

K



Capacitance Tolerance
C0G: J = ±5%
K = ±10%
M = ±20%
X7R: K = ±10%
M = ±20%
Z = +80%, -20%

A



Failure Rate
A=Not Applicable

1



Termination
1 = Pd/Ag
T = Plated Ni and Solder

1A



Packaging/Marking
1A = 7" Reel Unmarked
3A = 13" Reel Unmarked
9A = Bulk/Unmarked

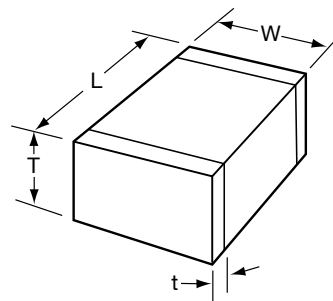

DIMENSIONS

millimeters (inches)

SIZE	1206	1210	1808*	1812*	1825*	2220*	2225*	3640*
(L) Length	3.20 ± 0.2 (0.126 ± 0.008)	3.20 ± 0.2 (0.126 ± 0.008)	4.57 ± 0.25 (0.180 ± 0.010)	4.50 ± 0.3 (0.177 ± 0.012)	4.50 ± 0.3 (0.177 ± 0.012)	5.7 ± 0.4 (0.224 ± 0.016)	5.72 ± 0.25 (0.225 ± 0.010)	9.14 ± 0.25 (0.360 ± 0.010)
(W) Width	1.60 ± 0.2 (0.063 ± 0.008)	2.50 ± 0.2 (0.098 ± 0.008)	2.03 ± 0.25 (0.080 ± 0.010)	3.20 ± 0.2 (0.126 ± 0.008)	6.40 ± 0.3 (0.252 ± 0.012)	5.0 ± 0.4 (0.197 ± 0.016)	6.35 ± 0.25 (0.250 ± 0.010)	10.2 ± 0.25 (0.400 ± 0.010)
(T) Thickness Max.	1.52 (0.060)	1.70 (0.067)	2.03 (0.080)	2.54 (0.100)	2.54 (0.100)	3.3 (0.130)	2.54 (0.100)	2.54 (0.100)
(t) terminal min. max.	0.25 (0.010) 0.75 (0.030)	0.25 (0.010) 0.75 (0.030)	0.25 (0.010) 1.02 (0.040)	0.25 (0.010) 1.02 (0.040)	0.25 (0.010) 1.02 (0.040)	0.25 (0.010) 1.02 (0.040)	0.25 (0.010) 1.02 (0.040)	0.76 (0.030) 1.52 (0.060)

*Reflow Soldering Only



High Voltage Chips



For 500V to 5000V Applications

C0G Dielectric

PERFORMANCE CHARACTERISTICS

Capacitance Range	10 pF to 0.047 μ F (25°C, 1.0 \pm 0.2 Vrms at 1kHz, for \leq 1000 pF use 1 MHz)
Capacitance Tolerances	\pm 5%, \pm 10%, \pm 20%
Dissipation Factor	0.1% max. (+25°C, 1.0 \pm 0.2 Vrms, 1kHz, for \leq 1000 pF use 1 MHz)
Operating Temperature Range	-55°C to +125°C
Temperature Characteristic	0 \pm 30 ppm/°C (0 VDC)
Voltage Ratings	500, 600, 1000, 1500, 2000, 2500, 3000, 4000 & 5000 VDC (+125°C)
Insulation Resistance (+25°C, at 500 VDC)	100K M Ω min. or 1000 M Ω - μ F min., whichever is less
Insulation Resistance (+125°C, at 500 VDC)	10K M Ω min. or 100 M Ω - μ F min., whichever is less
Dielectric Strength	500V, 150% rated voltage for 5 seconds at 50 mA max. current \geq 600V, 120% rated voltage for 5 seconds at 50 mA max. current

HIGH VOLTAGE C0G CAPACITANCE VALUES

VOLTAGE	1206	1210	1808	1812	1825	2220	2225	3640
500 min.	—	—	—	—	—	—	—	—
500 max.	680 pF	1500 pF	3300 pF	5600 pF	0.012 μ F	—	0.018 μ F	—
600 min.	100 pF	100 pF	100 pF	100 pF	1000 pF	1000 pF	1000 pF	1000 pF
600 max.	680 pF	1500 pF	2700 pF	5600 pF	0.012 μ F	0.012 μ F	0.015 μ F	0.047 μ F
1000 min.	10 pF	100 pF	100 pF	100 pF	100 pF	1000 pF	1000 pF	1000 pF
1000 max.	470 pF	820 pF	1500 pF	2700 pF	6800 pF	0.010 μ F	0.010 μ F	0.018 μ F
1500 min.	10 pF	100 pF	10 pF	10 pF	100 pF	1000 pF	1000 pF	100 pF
1500 max.	150 pF	330 pF	470 pF	1000 pF	2700 pF	2700 pF	3300 pF	8200 pF
2000 min.	10 pF	10 pF	10 pF	10 pF	100 pF	1000 pF	1000 pF	100 pF
2000 max.	68 pF	150 pF	270 pF	680 pF	1800 pF	2200 pF	2200 pF	5600 pF
2500 min.	—	—	10 pF	10 pF	10 pF	100 pF	100 pF	100 pF
2500 max.	—	—	150 pF	390 pF	1000 pF	1000 pF	1200 pF	3900 pF
3000 min.	—	—	10 pF	10 pF	10 pF	10 pF	10 pF	100 pF
3000 max.	—	—	100 pF	330 pF	680 pF	680 pF	820 pF	2200 pF
4000 min.	—	—	10 pF	10 pF	10 pF	10 pF	10 pF	100 pF
4000 max.	—	—	39 pF	100 pF	220 pF	220 pF	330 pF	1000 pF
5000 min.	—	—	—	—	—	—	—	10 pF
5000 max.	—	—	—	—	—	—	—	680 pF

X7R Dielectric

PERFORMANCE CHARACTERISTICS

Capacitance Range	10 pF to 0.56 μ F (25°C, 1.0 \pm 0.2 Vrms at 1kHz)
Capacitance Tolerances	\pm 10%; \pm 20%; +80%, -20%
Dissipation Factor	2.5% max. (+25°C, 1.0 \pm 0.2 Vrms, 1kHz)
Operating Temperature Range	-55°C to +125°C
Temperature Characteristic	\pm 15% (0 VDC)
Voltage Ratings	500,600, 1000, 1500, 2000, 2500, 3000, 4000 & 5000 VDC (+125°C)
Insulation Resistance (+25°C, at 500 VDC)	100K M Ω min. or 1000 M Ω - μ F min., whichever is less
Insulation Resistance (+125°C, at 500 VDC)	10K M Ω min. or 100 M Ω - μ F min., whichever is less
Dielectric Strength	500V, 150% rated voltage for 5 seconds at 50 mA max. current \geq 600V, 120% rated voltage for 5 seconds at 50 mA max. current

HIGH VOLTAGE X7R MAXIMUM CAPACITANCE VALUES

VOLTAGE	1206	1210	1808	1812	1825	2220	2225	3640
500 min.	—	—	—	—	—	—	—	—
500 max.	0.010 μ F	0.027 μ F	—	0.056 μ F	—	—	—	—
600 min.	1000 pF	1000 pF	.01 μ F	.01 μ F	.01 μ F	.01 μ F	.01 μ F	.01 μ F
600 max.	0.015 μ F	0.027 μ F	0.033 μ F	0.068 μ F	0.15 μ F	0.15 μ F	0.22 μ F	0.56 μ F
1000 min.	1000 pF	1000 pF	1000 pF	1000 pF	1000 pF	.01 μ F	.01 μ F	.01 μ F
1000 max.	4700 pF	0.010 μ F	0.015 μ F	0.027 μ F	0.068 μ F	0.068 μ F	0.082 μ F	0.22 μ F
1500 min.	100 pF	100 pF	100 pF	100 pF	1000 pF	1000 pF	1000 pF	.01 μ F
1500 max.	1200 pF	2700 pF	3900 pF	8200 pF	0.018 μ F	0.022 μ F	0.027 μ F	0.068 μ F
2000 min.	10 pF	100 pF	100 pF	100 pF	100 pF	1000 pF	1000 pF	1000 pF
2000 max.	470 pF	1000 pF	1800 pF	4700 pF	8200 pF	0.010 μ F	0.012 μ F	0.027 μ F
2500 min.	—	—	10 pF	10 pF	100 pF	1000 pF	1000 pF	1000 pF
2500 max.	—	—	1200 pF	2200 pF	5600 pF	6800 pF	8200 pF	0.022 μ F
3000 min.	—	—	10 pF	10 pF	100 pF	1000 pF	1000 pF	1000 pF
3000 max.	—	—	560 pF	1200 pF	2700 pF	3300 pF	4700 pF	0.018 μ F
4000 min.	—	—	—	—	—	—	—	100 pF
4000 max.	—	—	—	—	—	—	—	6800 pF
5000 min.	—	—	—	—	—	—	—	100 pF
5000 max.	—	—	—	—	—	—	—	3300 pF



MIL-PRF-55681/Chips

Part Number Example
CDR01 thru CDR06

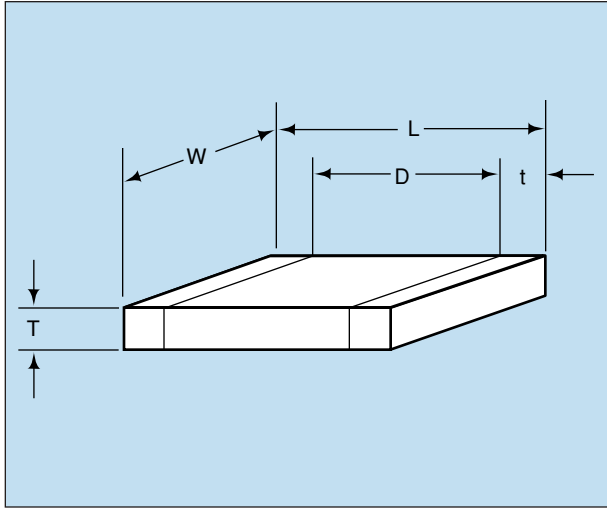

MILITARY DESIGNATION PER MIL-PRF-55681

Part Number Example

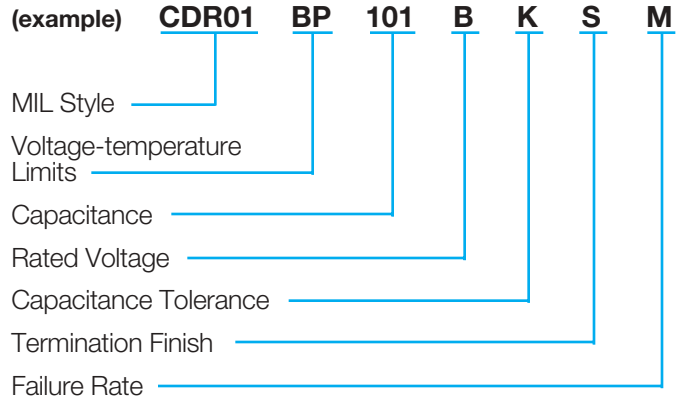

MIL Style: CDR01, CDR02, CDR03, CDR04, CDR05, CDR06

Voltage Temperature Limits:

BP = 0 ± 30 ppm/°C without voltage; 0 ± 30 ppm/°C with rated voltage from -55°C to +125°C

BX = $\pm 15\%$ without voltage; +15 -25% with rated voltage from -55°C to +125°C

Capacitance: Two digit figures followed by multiplier (number of zeros to be added) e.g., 101 = 100 pF

Rated Voltage: A = 50V, B = 100V

Capacitance Tolerance: J $\pm 5\%$, K $\pm 10\%$, M $\pm 20\%$

Termination Finish:

M = Palladium Silver
 N = Silver Nickel Gold
 S = Solder-coated

U = Base Metallization/Barrier Metal/Solder Coated*
 W = Base Metallization/Barrier Metal/Tinned (Tin or Tin/Lead Alloy)

*Solder shall have a melting point of 200°C or less.

Failure Rate Level: M = 1.0%, P = .1%, R = .01%, S = .001%

Packaging: Bulk is standard packaging. Tape and reel per RS481 is available upon request.

CROSS REFERENCE: AVX/MIL-PRF-55681/CDR01 THRU CDR06*

Per MIL-PRF-55681	AVX Style	Length (L)	Width (W)	Thickness (T)		D		Termination Band (t)	
				Max.	Min.	Max.	Min.	Max.	Min.
CDR01	0805	.080 ± .015	.050 ± .015	.055	.020	—	.030	—	.010
CDR02	1805	.180 ± .015	.050 ± .015	.055	.020	—	—	.030	.010
CDR03	1808	.180 ± .015	.080 ± .018	.080	.020	—	—	.030	.010
CDR04	1812	.180 ± .015	.125 ± .015	.080	.020	—	—	.030	.010
CDR05	1825	.180 ^{+.020} _{-.015}	.250 ^{+.020} _{-.015}	.080	.020	—	—	.030	.010
CDR06	2225	.225 ± .020	.250 ± .020	.080	.020	—	—	.030	.010

*For CDR11, 12, 13, and 14 see AVX Microwave Chip Capacitor Catalog

MIL-PRF-55681/Chips

Military Part Number Identification

CDR01 thru CDR06



CDR01 thru CDR06 to MIL-PRF-55681

Military Type Designation	Capacitance in pF	Capacitance tolerance	Rated temperature and voltage-temperature limits	WVDC
AVX Style 0805/CDR01				
CDR01BP100B---	10	J,K	BP	100
CDR01BP120B---	12	J	BP	100
CDR01BP150B---	15	J,K	BP	100
CDR01BP180B---	18	J	BP	100
CDR01BP220B---	22	J,K	BP	100
CDR01BP270B---	27	J	BP	100
CDR01BP330B---	33	J,K	BP	100
CDR01BP390B---	39	J	BP	100
CDR01BP470B---	47	J,K	BP	100
CDR01BP560B---	56	J	BP	100
CDR01BP680B---	68	J,K	BP	100
CDR01BP820B---	82	J	BP	100
CDR01BP101B---	100	J,K	BP	100
CDR01B--121B---	120	J,K	BP,BX	100
CDR01B--151B---	150	J,K	BP,BX	100
CDR01B--181B---	180	J,K	BP,BX	100
CDR01BX221B---	220	K,M	BX	100
CDR01BX271B---	270	K	BX	100
CDR01BX331B---	330	K,M	BX	100
CDR01BX391B---	390	K	BX	100
CDR01BX471B---	470	K,M	BX	100
CDR01BX561B---	560	K	BX	100
CDR01BX681B---	680	K,M	BX	100
CDR01BX821B---	820	K	BX	100
CDR01BX102B---	1000	K,M	BX	100
CDR01BX122B---	1200	K	BX	100
CDR01BX152B---	1500	K,M	BX	100
CDR01BX182B---	1800	K	BX	100
CDR01BX222B---	2200	K,M	BX	100
CDR01BX272B---	2700	K	BX	100
CDR01BX332B---	3300	K,M	BX	100
CDR01BX392A---	3900	K	BX	50
CDR01BX472A---	4700	K,M	BX	50
AVX Style 1805/CDR02				
CDR02BP221B---	220	J,K	BP	100
CDR02BP271B---	270	J	BP	100
CDR02BX392B---	3900	K	BX	100
CDR02BX472B---	4700	K,M	BX	100
CDR02BX562B---	5600	K	BX	100
CDR02BX682B---	6800	K,M	BX	100
CDR02BX822B---	8200	K	BX	100
CDR02BX103B---	10,000	K,M	BX	100
CDR02BX123A---	12,000	K	BX	50
CDR02BX153A---	15,000	K,M	BX	50
CDR02BX183A---	18,000	K	BX	50
CDR02BX223A---	22,000	K,M	BX	50

- Add appropriate failure rate
- Add appropriate termination finish
- Capacitance Tolerance

Military Type Designation	Capacitance in pF	Capacitance tolerance	Rated temperature and voltage-temperature limits	WVDC
AVX Style 1808/CDR03				
CDR03BP331B---	330	J,K	BP	100
CDR03BP391B---	390	J	BP	100
CDR03BP471B---	470	J,K	BP	100
CDR03BP561B---	560	J	BP	100
CDR03BP681B---	680	J,K	BP	100
CDR03BP821B---	820	J	BP	100
CDR03BP102B---	1000	J,K	BP	100
CDR03BX123B---	12,000	K	BX	100
CDR03BX153B---	15,000	K,M	BX	100
CDR03BX183B---	18,000	K	BX	100
CDR03BX223B---	22,000	K,M	BX	100
CDR03BX273B---	27,000	K	BX	100
CDR03BX333B---	33,000	K,M	BX	100
CDR03BX393A---	39,000	K	BX	50
CDR03BX473A---	47,000	K,M	BX	50
CDR03BX563A---	56,000	K	BX	50
CDR03BX683A---	68,000	K,M	BX	50
AVX Style 1812/CDR04				
CDR04BP122B---	1200	J	BP	100
CDR04BP152B---	1500	J,K	BP	100
CDR04BP182B---	1800	J	BP	100
CDR04BP222B---	2200	J,K	BP	100
CDR04BP272B---	2700	J	BP	100
CDR04BP332B---	3300	J,K	BP	100
CDR04BX393B---	39,000	K	BX	100
CDR04BX473B---	47,000	K,M	BX	100
CDR04BX563B---	56,000	K	BX	100
CDR04BX823A---	82,000	K	BX	50
CDR04BX104A---	100,000	K,M	BX	50
CDR04BX124A---	120,000	K	BX	50
CDR04BX154A---	150,000	K,M	BX	50
CDR04BX184A---	180,000	K	BX	50
AVX Style 1825/CDR05				
CDR05BP392B---	3900	J,K	BP	100
CDR05BP472B---	4700	J,K	BP	100
CDR05BP562B---	5600	J,K	BP	100
CDR05BX683B---	68,000	K,M	BX	100
CDR05BX823B---	82,000	K	BX	100
CDR05BX104B---	100,000	K,M	BX	100
CDR05BX124B---	120,000	K	BX	100
CDR05BX154B---	150,000	K,M	BX	100
CDR05BX224A---	220,000	K,M	BX	50
CDR05BX274A---	270,000	K	BX	50
CDR05BX334A---	330,000	K,M	BX	50
AVX Style 2225/CDR06				
CDR06BP682B---	6800	J,K	BP	100
CDR06BP822B---	8200	J,K	BP	100
CDR06BP103B---	10,000	J,K	BP	100
CDR06BX394A---	390,000	K	BX	50
CDR06BX474A---	470,000	K,M	BX	50

- Add appropriate failure rate
- Add appropriate termination finish
- Capacitance Tolerance



MIL-PRF-55681/Chips



Part Number Example CDR31 thru CDR35

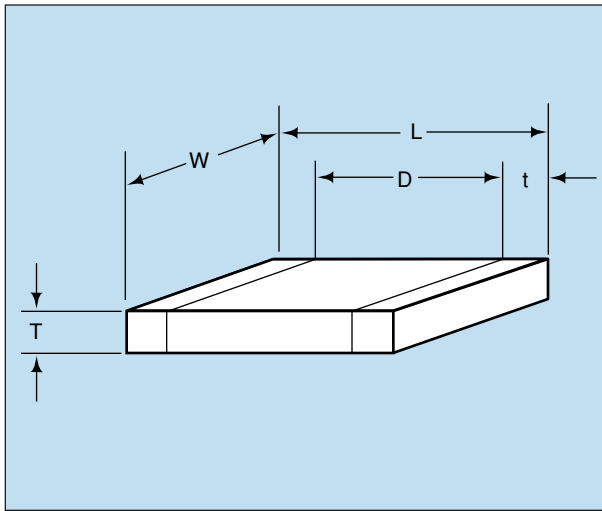

MILITARY DESIGNATION PER MIL-PRF-55681

Part Number Example

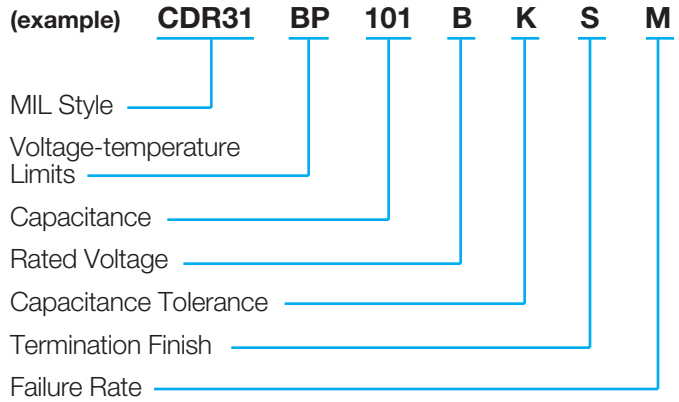

MIL Style: CDR31, CDR32, CDR33, CDR34, CDR35

Voltage Temperature Limits:

BP = 0 ± 30 ppm/°C without voltage; 0 ± 30 ppm/°C with rated voltage from -55°C to +125°C

BX = $\pm 15\%$ without voltage; +15 -25% with rated voltage from -55°C to +125°C

Capacitance: Two digit figures followed by multiplier (number of zeros to be added) e.g., 101 = 100 pF

Rated Voltage: A = 50V, B = 100V

Capacitance Tolerance: C $\pm .25$ pF, D $\pm .5$ pF, F $\pm 1\%$
J $\pm 5\%$, K $\pm 10\%$, M $\pm 20\%$

Termination Finish:

M = Palladium Silver
N = Silver Nickel Gold
S = Solder-coated

U = Base Metallization/Barrier Metal/Solder Coated*
W = Base Metallization/Barrier Metal/Tinned (Tin or Tin/Lead Alloy)

*Solder shall have a melting point of 200°C or less.

Failure Rate Level: M = 1.0%, P = .1%, R = .01%,
S = .001%

Packaging: Bulk is standard packaging. Tape and reel per RS481 is available upon request.

CROSS REFERENCE: AVX/MIL-PRF-55681/CDR31 THRU CDR35

Per MIL-PRF-55681 (Metric Sizes)	AVX Style	Length (L) (mm)	Width (W) (mm)	Thickness (T)	D	Termination Band (t)	
				Max. (mm)		Min. (mm)	Max. (mm)
CDR31	0805	2.00	1.25	1.3	.50	.70	.30
CDR32	1206	3.20	1.60	1.3	—	.70	.30
CDR33	1210	3.20	2.50	1.5	—	.70	.30
CDR34	1812	4.50	3.20	1.5	—	.70	.30
CDR35	1825	4.50	6.40	1.5	—	.70	.30

MIL-PRF-55681/Chips



Military Part Number Identification CDR31

CDR31 to MIL-PRF-55681/7

Military Type Designation 1/	Capacitance in pF	Capacitance tolerance	Rated temperature and voltage-temperature limits	WVDC
AVX Style 0805/CDR31 (BP)				
CDR31BP1R0B---	1.0	B,C	BP	100
CDR31BP1R1B---	1.1	B,C	BP	100
CDR31BP1R2B---	1.2	B,C	BP	100
CDR31BP1R3B---	1.3	B,C	BP	100
CDR31BP1R5B---	1.5	B,C	BP	100
CDR31BP1R6B---	1.6	B,C	BP	100
CDR31BP1R8B---	1.8	B,C	BP	100
CDR31BP2R0B---	2.0	B,C	BP	100
CDR31BP2R2B---	2.2	B,C	BP	100
CDR31BP2R4B---	2.4	B,C	BP	100
CDR31BP2R7B---	2.7	B,C,D	BP	100
CDR31BP3R0B---	3.0	B,C,D	BP	100
CDR31BP3R3B---	3.3	B,C,D	BP	100
CDR31BP3R6B---	3.6	B,C,D	BP	100
CDR31BP3R9B---	3.9	B,C,D	BP	100
CDR31BP4R3B---	4.3	B,C,D	BP	100
CDR31BP4R7B---	4.7	B,C,D	BP	100
CDR31BP5R1B---	5.1	B,C,D	BP	100
CDR31BP5R6B---	5.6	B,C,D	BP	100
CDR31BP6R2B---	6.2	B,C,D	BP	100
CDR31BP6R8B---	6.8	B,C,D	BP	100
CDR31BP7R5B---	7.5	B,C,D	BP	100
CDR31BP8R2B---	8.2	B,C,D	BP	100
CDR31BP9R1B---	9.1	B,C,D	BP	100
CDR31BP100B---	10	F,J,K	BP	100
CDR31BP110B---	11	F,J,K	BP	100
CDR31BP120B---	12	F,J,K	BP	100
CDR31BP130B---	13	F,J,K	BP	100
CDR31BP150B---	15	F,J,K	BP	100
CDR31BP160B---	16	F,J,K	BP	100
CDR31BP180B---	18	F,J,K	BP	100
CDR31BP200B---	20	F,J,K	BP	100
CDR31BP220B---	22	F,J,K	BP	100
CDR31BP240B---	24	F,J,K	BP	100
CDR31BP270B---	27	F,J,K	BP	100
CDR31BP300B---	30	F,J,K	BP	100
CDR31BP330B---	33	F,J,K	BP	100
CDR31BP360B---	36	F,J,K	BP	100
CDR31BP390B---	39	F,J,K	BP	100
CDR31BP430B---	43	F,J,K	BP	100
CDR31BP470B---	47	F,J,K	BP	100
CDR31BP510B---	51	F,J,K	BP	100
CDR31BP560B---	56	F,J,K	BP	100
CDR31BP620B---	62	F,J,K	BP	100
CDR31BP680B---	68	F,J,K	BP	100
CDR31BP750B---	75	F,J,K	BP	100
CDR31BP820B---	82	F,J,K	BP	100
CDR31BP910B---	91	F,J,K	BP	100

- Add appropriate failure rate
- Add appropriate termination finish
- Capacitance Tolerance

Military Type Designation 1/	Capacitance in pF	Capacitance tolerance	Rated temperature and voltage-temperature limits	WVDC
AVX Style 0805/CDR31 (BP) cont'd				
CDR31BP101B---	100	F,J,K	BP	100
CDR31BP111B---	110	F,J,K	BP	100
CDR31BP121B---	120	F,J,K	BP	100
CDR31BP131B---	130	F,J,K	BP	100
CDR31BP151B---	150	F,J,K	BP	100
CDR31BP161B---	160	F,J,K	BP	100
CDR31BP181B---	180	F,J,K	BP	100
CDR31BP201B---	200	F,J,K	BP	100
CDR31BP221B---	220	F,J,K	BP	100
CDR31BP241B---	240	F,J,K	BP	100
CDR31BP271B---	270	F,J,K	BP	100
CDR31BP301B---	300	F,J,K	BP	100
CDR31BP331B---	330	F,J,K	BP	100
CDR31BP361B---	360	F,J,K	BP	100
CDR31BP391B---	390	F,J,K	BP	100
CDR31BP431B---	430	F,J,K	BP	100
CDR31BP471B---	470	F,J,K	BP	100
CDR31BP511A---	510	F,J,K	BP	50
CDR31BP561A---	560	F,J,K	BP	50
CDR31BP621A---	620	F,J,K	BP	50
CDR31BP681A---	680	F,J,K	BP	50
AVX Style 0805/CDR31 (BX)				
CDR31BX471B---	470	K,M	BX	100
CDR31BX561B---	560	K,M	BX	100
CDR31BX681B---	680	K,M	BX	100
CDR31BX821B---	820	K,M	BX	100
CDR31BX102B---	1,000	K,M	BX	100
CDR31BX122B---	1,200	K,M	BX	100
CDR31BX152B---	1,500	K,M	BX	100
CDR31BX182B---	1,800	K,M	BX	100
CDR31BX222B---	2,200	K,M	BX	100
CDR31BX272B---	2,700	K,M	BX	100
CDR31BX332B---	3,300	K,M	BX	100
CDR31BX392B---	3,900	K,M	BX	100
CDR31BX472B---	4,700	K,M	BX	100
CDR31BX562A---	5,600	K,M	BX	50
CDR31BX682A---	6,800	K,M	BX	50
CDR31BX822A---	8,200	K,M	BX	50
CDR31BX103A---	10,000	K,M	BX	50
CDR31BX123A---	12,000	K,M	BX	50
CDR31BX153A---	15,000	K,M	BX	50
CDR31BX183A---	18,000	K,M	BX	50

- Add appropriate failure rate
- Add appropriate termination finish
- Capacitance Tolerance

1/ The complete part number will include additional symbols to indicate capacitance tolerance, termination and failure rate level.



MIL-PRF-55681/Chips



Military Part Number Identification CDR32

CDR32 to MIL-PRF-55681/8

Military Type Designation 1/	Capacitance in pF	Capacitance tolerance	Rated temperature and voltage-temperature limits	WVDC
AVX Style 1206/CDR32 (BP)				
CDR32BP1R0B---	1.0	B,C	BP	100
CDR32BP1R1B---	1.1	B,C	BP	100
CDR32BP1R2B---	1.2	B,C	BP	100
CDR32BP1R3B---	1.3	B,C	BP	100
CDR32BP1R5B---	1.5	B,C	BP	100
CDR32BP1R6B---	1.6	B,C	BP	100
CDR32BP1R8B---	1.8	B,C	BP	100
CDR32BP2R0B---	2.0	B,C	BP	100
CDR32BP2R2B---	2.2	B,C	BP	100
CDR32BP2R4B---	2.4	B,C	BP	100
CDR32BP2R7B---	2.7	B,C,D	BP	100
CDR32BP3R0B---	3.0	B,C,D	BP	100
CDR32BP3R3B---	3.3	B,C,D	BP	100
CDR32BP3R6B---	3.6	B,C,D	BP	100
CDR32BP3R9B---	3.9	B,C,D	BP	100
CDR32BP4R3B---	4.3	B,C,D	BP	100
CDR32BP4R7B---	4.7	B,C,D	BP	100
CDR32BP5R1B---	5.1	B,C,D	BP	100
CDR32BP5R6B---	5.6	B,C,D	BP	100
CDR32BP6R2B---	6.2	B,C,D	BP	100
CDR32BP6R8B---	6.8	B,C,D	BP	100
CDR32BP7R5B---	7.5	B,C,D	BP	100
CDR32BP8R2B---	8.2	B,C,D	BP	100
CDR32BP9R1B---	9.1	B,C,D	BP	100
CDR32BP100B---	10	F,J,K	BP	100
CDR32BP110B---	11	F,J,K	BP	100
CDR32BP120B---	12	F,J,K	BP	100
CDR32BP130B---	13	F,J,K	BP	100
CDR32BP150B---	15	F,J,K	BP	100
CDR32BP160B---	16	F,J,K	BP	100
CDR32BP180B---	18	F,J,K	BP	100
CDR32BP200B---	20	F,J,K	BP	100
CDR32BP220B---	22	F,J,K	BP	100
CDR32BP240B---	24	F,J,K	BP	100
CDR32BP270B---	27	F,J,K	BP	100
CDR32BP300B---	30	F,J,K	BP	100
CDR32BP330B---	33	F,J,K	BP	100
CDR32BP360B---	36	F,J,K	BP	100
CDR32BP390B---	39	F,J,K	BP	100
CDR32BP430B---	43	F,J,K	BP	100
CDR32BP470B---	47	F,J,K	BP	100
CDR32BP510B---	51	F,J,K	BP	100
CDR32BP560B---	56	F,J,K	BP	100
CDR32BP620B---	62	F,J,K	BP	100
CDR32BP680B---	68	F,J,K	BP	100
CDR32BP750B---	75	F,J,K	BP	100
CDR32BP820B---	82	F,J,K	BP	100
CDR32BP910B---	91	F,J,K	BP	100

- Add appropriate failure rate
- Add appropriate termination finish
- Capacitance Tolerance

Military Type Designation 1/	Capacitance in pF	Capacitance tolerance	Rated temperature and voltage-temperature limits	WVDC
AVX Style 1206/CDR32 (BP) cont'd				
CDR32BP101B---	100	F,J,K	BP	100
CDR32BP111B---	110	F,J,K	BP	100
CDR32BP121B---	120	F,J,K	BP	100
CDR32BP131B---	130	F,J,K	BP	100
CDR32BP151B---	150	F,J,K	BP	100
CDR32BP161B---	160	F,J,K	BP	100
CDR32BP181B---	180	F,J,K	BP	100
CDR32BP201B---	200	F,J,K	BP	100
CDR32BP221B---	220	F,J,K	BP	100
CDR32BP241B---	240	F,J,K	BP	100
CDR32BP271B---	270	F,J,K	BP	100
CDR32BP301B---	300	F,J,K	BP	100
CDR32BP331B---	330	F,J,K	BP	100
CDR32BP361B---	360	F,J,K	BP	100
CDR32BP391B---	390	F,J,K	BP	100
CDR32BP431B---	430	F,J,K	BP	100
CDR32BP471B---	470	F,J,K	BP	100
CDR32BP511B---	510	F,J,K	BP	100
CDR32BP561B---	560	F,J,K	BP	100
CDR32BP621B---	620	F,J,K	BP	100
CDR32BP681B---	680	F,J,K	BP	100
CDR32BP751B---	750	F,J,K	BP	100
CDR32BP821B---	820	F,J,K	BP	100
CDR32BP911B---	910	F,J,K	BP	100
CDR32BP102B---	1,000	F,J,K	BP	100
CDR32BP112A---	1,100	F,J,K	BP	50
CDR32BP122A---	1,200	F,J,K	BP	50
CDR32BP132A---	1,300	F,J,K	BP	50
CDR32BP152A---	1,500	F,J,K	BP	50
CDR32BP162A---	1,600	F,J,K	BP	50
CDR32BP182A---	1,800	F,J,K	BP	50
CDR32BP202A---	2,000	F,J,K	BP	50
CDR32BP222A---	2,200	F,J,K	BP	50
AVX Style 1206/CDR32 (BX)				
CDR32BX472B---	4,700	K,M	BX	100
CDR32BX562B---	5,600	K,M	BX	100
CDR32BX682B---	6,800	K,M	BX	100
CDR32BX822B---	8,200	K,M	BX	100
CDR32BX103B---	10,000	K,M	BX	100
CDR32BX123B---	12,000	K,M	BX	100
CDR32BX153B---	15,000	K,M	BX	100
CDR32BX183A---	18,000	K,M	BX	50
CDR32BX223A---	22,000	K,M	BX	50
CDR32BX273A---	27,000	K,M	BX	50
CDR32BX333A---	33,000	K,M	BX	50
CDR32BX393A---	39,000	K,M	BX	50

- Add appropriate failure rate
- Add appropriate termination finish
- Capacitance Tolerance

1/ The complete part number will include additional symbols to indicate capacitance tolerance, termination and failure rate level.

CDR33/34/35 to MIL-PRF-55681/9/10/11

Military Type Designation 1/	Capacitance in pF	Capacitance tolerance	Rated temperature and voltage-temperature limits	WVDC
AVX Style 1210/CDR33 (BP)				
CDR33BP102B---	1,000	F,J,K	BP	100
CDR33BP112B---	1,100	F,J,K	BP	100
CDR33BP122B---	1,200	F,J,K	BP	100
CDR33BP132B---	1,300	F,J,K	BP	100
CDR33BP152B---	1,500	F,J,K	BP	100
CDR33BP162B---	1,600	F,J,K	BP	100
CDR33BP182B---	1,800	F,J,K	BP	100
CDR33BP202B---	2,000	F,J,K	BP	100
CDR33BP222B---	2,200	F,J,K	BP	100
CDR33BP242A---	2,400	F,J,K	BP	50
CDR33BP272A---	2,700	F,J,K	BP	50
CDR33BP302A---	3,000	F,J,K	BP	50
CDR33BP332A---	3,300	F,J,K	BP	50
AVX Style 1210/CDR33 (BX)				
CDR33BX153B---	15,000	K,M	BX	100
CDR33BX183B---	18,000	K,M	BX	100
CDR33BX223B---	22,000	K,M	BX	100
CDR33BX273B---	27,000	K,M	BX	100
CDR33BX393A---	39,000	K,M	BX	50
CDR33BX473A---	47,000	K,M	BX	50
CDR33BX563A---	56,000	K,M	BX	50
CDR33BX683A---	68,000	K,M	BX	50
CDR33BX823A---	82,000	K,M	BX	50
CDR33BX104A---	100,000	K,M	BX	50
AVX Style 1812/CDR34 (BP)				
CDR34BP222B---	2,200	F,J,K	BP	100
CDR34BP242B---	2,400	F,J,K	BP	100
CDR34BP272B---	2,700	F,J,K	BP	100
CDR34BP302B---	3,000	F,J,K	BP	100
CDR34BP332B---	3,300	F,J,K	BP	100
CDR34BP362B---	3,600	F,J,K	BP	100
CDR34BP392B---	3,900	F,J,K	BP	100
CDR34BP432B---	4,300	F,J,K	BP	100
CDR34BP472B---	4,700	F,J,K	BP	100
CDR34BP512A---	5,100	F,J,K	BP	50
CDR34BP562A---	5,600	F,J,K	BP	50
CDR34BP622A---	6,200	F,J,K	BP	50
CDR34BP682A---	6,800	F,J,K	BP	50
CDR34BP752A---	7,500	F,J,K	BP	50
CDR34BP822A---	8,200	F,J,K	BP	50
CDR34BP912A---	9,100	F,J,K	BP	50
CDR34BP103A---	10,000	F,J,K	BP	50

- Add appropriate failure rate
- Add appropriate termination finish
- Capacitance Tolerance

Military Type Designation 1/	Capacitance in pF	Capacitance tolerance	Rated temperature and voltage-temperature limits	WVDC
AVX Style 1812/CDR34 (BX)				
CDR34BX273B---	27,000	K,M	BX	100
CDR34BX333B---	33,000	K,M	BX	100
CDR34BX393B---	39,000	K,M	BX	100
CDR34BX473B---	47,000	K,M	BX	100
CDR34BX563B---	56,000	K,M	BX	100
CDR34BX104A---	100,000	K,M	BX	50
CDR34BX124A---	120,000	K,M	BX	50
CDR34BX154A---	150,000	K,M	BX	50
CDR34BX184A---	180,000	K,M	BX	50
AVX Style 1825/CDR35 (BP)				
CDR35BP472B---	4,700	F,J,K	BP	100
CDR35BP512B---	5,100	F,J,K	BP	100
CDR35BP562B---	5,600	F,J,K	BP	100
CDR35BP622B---	6,200	F,J,K	BP	100
CDR35BP682B---	6,800	F,J,K	BP	100
CDR35BP752B---	7,500	F,J,K	BP	100
CDR35BP822B---	8,200	F,J,K	BP	100
CDR35BP912B---	9,100	F,J,K	BP	100
CDR35BP103B---	10,000	F,J,K	BP	100
CDR35BP113A---	11,000	F,J,K	BP	50
CDR35BP123A---	12,000	F,J,K	BP	50
CDR35BP133A---	13,000	F,J,K	BP	50
CDR35BP153A---	15,000	F,J,K	BP	50
CDR35BP163A---	16,000	F,J,K	BP	50
CDR35BP183A---	18,000	F,J,K	BP	50
CDR35BP203A---	20,000	F,J,K	BP	50
CDR35BP223A---	22,000	F,J,K	BP	50
AVX Style 1825/CDR35 (BX)				
CDR35BX563B---	56,000	K,M	BX	100
CDR35BX683B---	68,000	K,M	BX	100
CDR35BX823B---	82,000	K,M	BX	100
CDR35BX104B---	100,000	K,M	BX	100
CDR35BX124B---	120,000	K,M	BX	100
CDR35BX154B---	150,000	K,M	BX	100
CDR35BX184A---	180,000	K,M	BX	50
CDR35BX224A---	220,000	K,M	BX	50
CDR35BX274A---	270,000	K,M	BX	50
CDR35BX334A---	330,000	K,M	BX	50
CDR35BX394A---	390,000	K,M	BX	50
CDR35BX474A---	470,000	K,M	BX	50

- Add appropriate failure rate
- Add appropriate termination finish
- Capacitance Tolerance

1/ The complete part number will include additional symbols to indicate capacitance tolerance, termination and failure rate level.

Packaging of Chip Components



Automatic Insertion Packaging

TAPE & REEL QUANTITIES

All tape and reel specifications are in compliance with RS481.

	8mm	12mm	
Paper or Embossed Carrier	0612, 0508, 0805, 1206, 1210		
Embossed Only	0306	1808	1812, 1825 2220, 2225
Paper Only	0201, 0402, 0603		
Qty. per Reel/7" Reel	2,000, 3,000 or 4,000, 10,000, 15,000 Contact factory for exact quantity	3,000	500, 1,000 Contact factory for exact quantity
Qty. per Reel/13" Reel	5,000, 10,000, 50,000 Contact factory for exact quantity	10,000	4,000

REEL DIMENSIONS

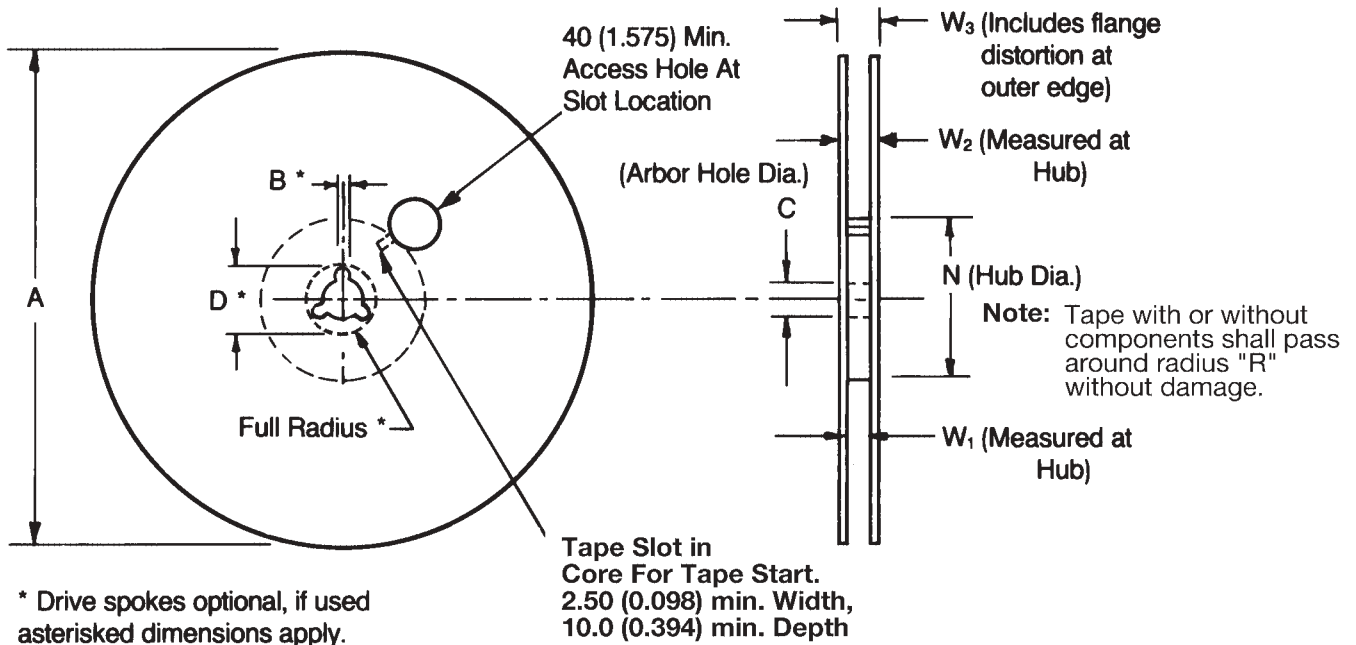

Tape Size ⁽¹⁾	A Max.	B* Min.	C	D* Min.	N Min.	W ₁	W ₂ Max.	W ₃
8mm	330 (12.992)	1.5 (0.059)	13.0 ^{+0.50} _{-0.20} (0.512 ^{+0.020} _{-0.008})	20.2 (0.795)	50.0 (1.969)	8.40 ^{+1.5} _{-0.8} (0.331 ^{+0.059} _{-0.0})	14.4 (0.567)	7.90 Min. (0.311)
12mm						12.4 ^{+2.0} _{-0.0} (0.488 ^{+0.079} _{-0.0})		11.9 Min. (0.469)

Metric dimensions will govern.

English measurements rounded and for reference only.

(1) For tape sizes 16mm and 24mm (used with chip size 3640) consult EIA RS-481 latest revision.



Embossed Carrier Configuration



8 & 12mm Tape Only

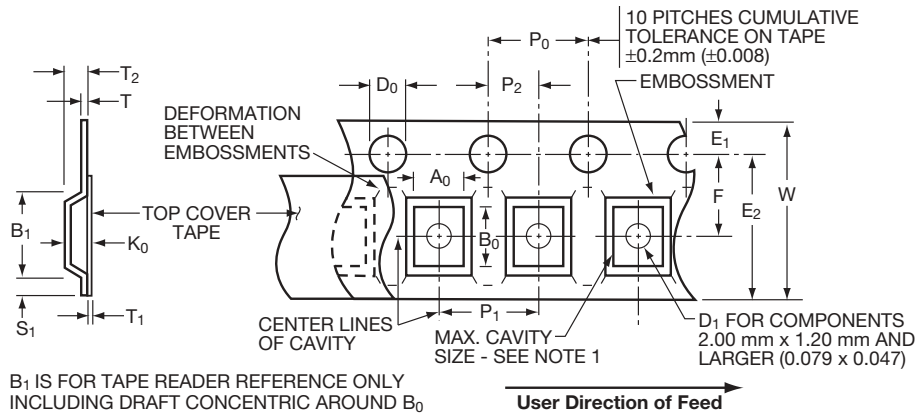

8 & 12mm Embossed Tape Metric Dimensions Will Govern

CONSTANT DIMENSIONS

Tape Size	D_0	E	P_0	P_2	S_1 Min.	T Max.	T_1
8mm and 12mm	$1.50^{+0.10}_{-0.0}$ ($0.059^{+0.004}_{-0.0}$)	1.75 ± 0.10 (0.069 ± 0.004)	4.0 ± 0.10 (0.157 ± 0.004)	2.0 ± 0.05 (0.079 ± 0.002)	0.60 (0.024)	0.60 (0.024)	0.10 (0.004) Max.

VARIABLE DIMENSIONS

Tape Size	B_1 Max.	D_1 Min.	E_2 Min.	F	P_1 See Note 5	R Min. See Note 2	T_2	W Max.	$A_0 B_0 K_0$
8mm	4.35 (0.171)	1.00 (0.039)	6.25 (0.246)	3.50 ± 0.05 (0.138 ± 0.002)	4.00 ± 0.10 (0.157 ± 0.004)	25.0 (0.984)	2.50 Max. (0.098)	8.30 (0.327)	See Note 1
12mm	8.20 (0.323)	1.50 (0.059)	10.25 (0.404)	5.50 ± 0.05 (0.217 ± 0.002)	4.00 ± 0.10 (0.157 ± 0.004)	30.0 (1.181)	6.50 Max. (0.256)	12.3 (0.484)	See Note 1
8mm 1/2 Pitch	4.35 (0.171)	1.00 (0.039)	6.25 (0.246)	3.50 ± 0.05 (0.138 ± 0.002)	2.00 ± 0.10 (0.079 ± 0.004)	25.0 (0.984)	2.50 Max. (0.098)	8.30 (0.327)	See Note 1
12mm Double Pitch	8.20 (0.323)	1.50 (0.059)	10.25 (0.404)	5.50 ± 0.05 (0.217 ± 0.002)	8.00 ± 0.10 (0.315 ± 0.004)	30.0 (1.181)	6.50 Max. (0.256)	12.3 (0.484)	See Note 1

NOTES:

1. The cavity defined by A_0 , B_0 , and K_0 shall be configured to provide the following:

Surround the component with sufficient clearance such that:

- the component does not protrude beyond the sealing plane of the cover tape.
- the component can be removed from the cavity in a vertical direction without mechanical restriction, after the cover tape has been removed.
- rotation of the component is limited to 20° maximum (see Sketches D & E).
- lateral movement of the component is restricted to 0.5mm maximum (see Sketch F).

2. Tape with or without components shall pass around radius "R" without damage.

3. Bar code labeling (if required) shall be on the side of the reel opposite the round sprocket holes. Refer to EIA-556.

4. B_1 dimension is a reference dimension for tape feeder clearance only.

5. If $P_1 = 2.0\text{mm}$, the tape may not properly index in all tape feeders.

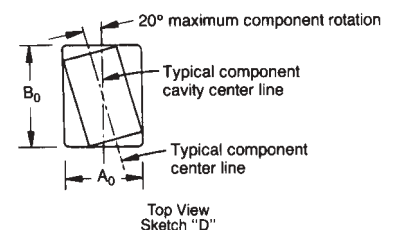
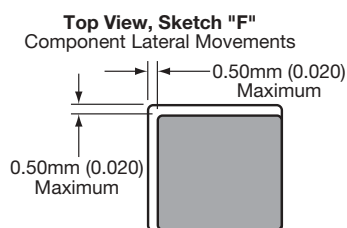
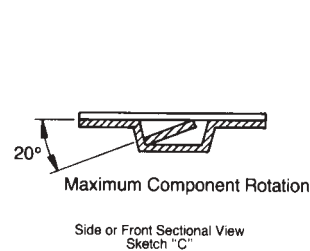

Paper Carrier Configuration



8 & 12mm Tape Only

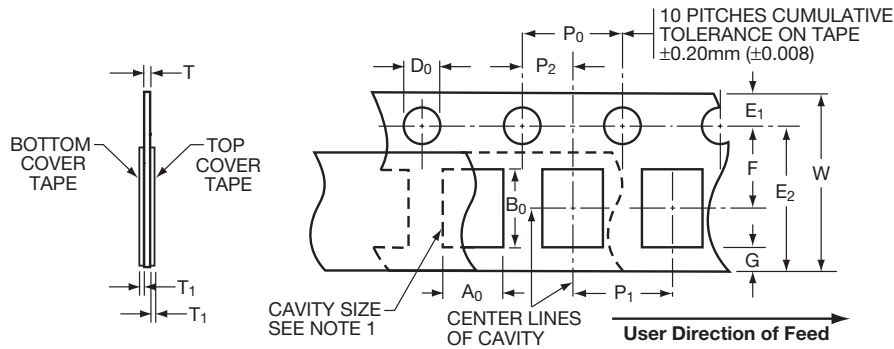

8 & 12mm Paper Tape Metric Dimensions Will Govern

CONSTANT DIMENSIONS

Tape Size	D ₀	E	P ₀	P ₂	T ₁	G. Min.	R Min.
8mm and 12mm	1.50 ^{+0.10} _{-0.004} (0.059 ^{+0.004} _{-0.004})	1.75 ± 0.10 (0.069 ± 0.004)	4.00 ± 0.10 (0.157 ± 0.004)	2.00 ± 0.05 (0.079 ± 0.002)	0.10 (0.004) Max.	0.75 (0.030) Min.	25.0 (0.984) See Note 2 Min.

VARIABLE DIMENSIONS

Tape Size	P ₁ See Note 4	E ₂ Min.	F	W	A ₀ B ₀	T
8mm	4.00 ± 0.10 (0.157 ± 0.004)	6.25 (0.246)	3.50 ± 0.05 (0.138 ± 0.002)	8.00 ^{+0.30} _{-0.10} (0.315 ^{+0.012} _{-0.004})	See Note 1	1.10mm (0.043) Max. for Paper Base Tape and 1.60mm (0.063) Max. for Non-Paper Base Compositions
12mm	4.00 ± 0.010 (0.157 ± 0.004)	10.25 (0.404)	5.50 ± 0.05 (0.217 ± 0.002)	12.0 ± 0.30 (0.472 ± 0.012)		
8mm 1/2 Pitch	2.00 ± 0.05 (0.079 ± 0.002)	6.25 (0.246)	3.50 ± 0.05 (0.138 ± 0.002)	8.00 ^{+0.30} _{-0.10} (0.315 ^{+0.012} _{-0.004})		
12mm Double Pitch	8.00 ± 0.10 (0.315 ± 0.004)	10.25 (0.404)	5.50 ± 0.05 (0.217 ± 0.002)	12.0 ± 0.30 (0.472 ± 0.012)		

NOTES:

- The cavity defined by A₀, B₀, and T shall be configured to provide sufficient clearance surrounding the component so that:
 - the component does not protrude beyond either surface of the carrier tape;
 - the component can be removed from the cavity in a vertical direction without mechanical restriction after the top cover tape has been removed;
 - rotation of the component is limited to 20° maximum (see Sketches A & B);
 - lateral movement of the component is restricted to 0.5mm maximum (see Sketch C).
- Tape with or without components shall pass around radius "R" without damage.
- Bar code labeling (if required) shall be on the side of the reel opposite the sprocket holes. Refer to EIA-556.
- If P₁ = 2.0mm, the tape may not properly index in all tape feeders.

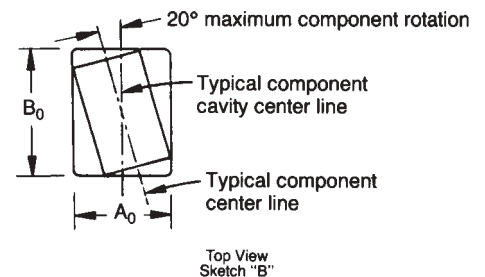
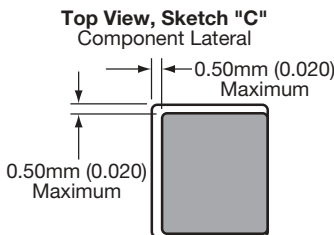
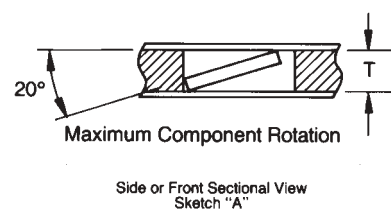

Bar Code Labeling Standard

AVX bar code labeling is available and follows latest version of EIA-556



BENEFITS

- Easier handling
- Smaller packaging volume
(1/20 of T/R packaging)
- Easier inventory control
- Flexibility
- Recyclable

CASE DIMENSIONS

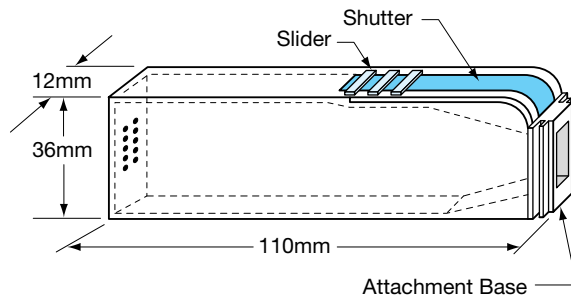

BULK FEEDER

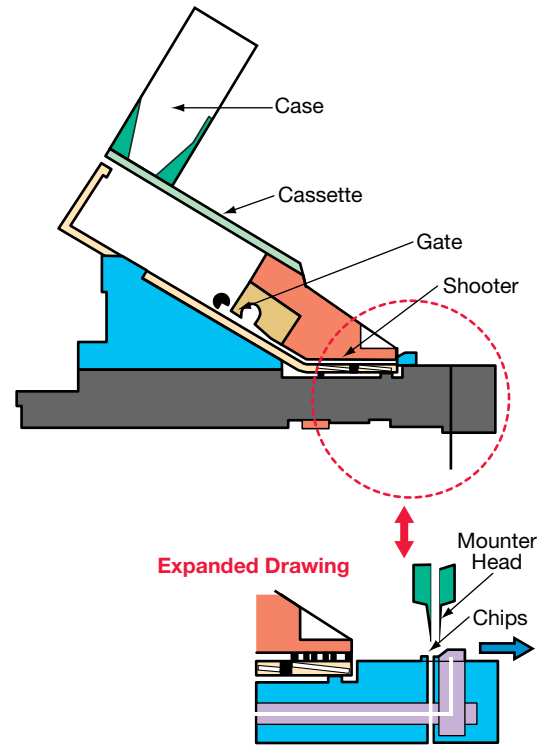

CASE QUANTITIES

Part Size	0402	0603	0805	1206
Qty. (pcs / cassette)	80,000	15,000	10,000 (T=.023") 8,000 (T=.031") 6,000 (T=.043")	5,000 (T=.023") 4,000 (T=.032") 3,000 (T=.044")

I. Capacitance (farads)

English: $C = \frac{.224 \text{ K A}}{T_D}$

Metric: $C = \frac{.0884 \text{ K A}}{T_D}$

II. Energy stored in capacitors (Joules, watt - sec)

$$E = \frac{1}{2} CV^2$$

III. Linear charge of a capacitor (Amperes)

$$I = C \frac{dV}{dt}$$

IV. Total Impedance of a capacitor (ohms)

$$Z = \sqrt{R_s^2 + (X_C - X_L)^2}$$

V. Capacitive Reactance (ohms)

$$X_C = \frac{1}{2 \pi fC}$$

VI. Inductive Reactance (ohms)

$$X_L = 2 \pi fL$$

VII. Phase Angles:

Ideal Capacitors: Current leads voltage 90°

Ideal Inductors: Current lags voltage 90°

Ideal Resistors: Current in phase with voltage

VIII. Dissipation Factor (%)

$$\text{D.F.} = \tan \delta \text{ (loss angle)} = \frac{\text{E.S.R.}}{X_C} = (2 \pi fC) \text{ (E.S.R.)}$$

IX. Power Factor (%)

P.F. = Sine δ (loss angle) = Cos ϕ (phase angle)

P.F. = (when less than 10%) = DF

X. Quality Factor (dimensionless)

$$Q = \text{Cotan } \delta \text{ (loss angle)} = \frac{1}{\text{D.F.}}$$

XI. Equivalent Series Resistance (ohms)

$$\text{E.S.R.} = (\text{D.F.}) (X_C) = (\text{D.F.}) / (2 \pi fC)$$

XII. Power Loss (watts)

$$\text{Power Loss} = (2 \pi fCV^2) \text{ (D.F.)}$$

XIII. KVA (Kilowatts)

$$\text{KVA} = 2 \pi fCV^2 \times 10^{-3}$$

XIV. Temperature Characteristic (ppm/°C)

$$\text{T.C.} = \frac{C_t - C_{25}}{C_{25} (T_t - 25)} \times 10^6$$

XV. Cap Drift (%)

$$\text{C.D.} = \frac{C_1 - C_2}{C_1} \times 100$$

XVI. Reliability of Ceramic Capacitors

$$\frac{L_o}{L_t} = \left(\frac{V_t}{V_o} \right)^X \left(\frac{T_t}{T_o} \right)^Y$$

XVII. Capacitors in Series (current the same)

$$\text{Any Number: } \frac{1}{C_T} = \frac{1}{C_1} + \frac{1}{C_2} \dots \frac{1}{C_N}$$

$$\text{Two: } C_T = \frac{C_1 C_2}{C_1 + C_2}$$

XVIII. Capacitors in Parallel (voltage the same)

$$C_T = C_1 + C_2 \dots + C_N$$

XIX. Aging Rate

A.R. = % Δ C/decade of time

XX. Decibels

$$\text{db} = 20 \log \frac{V_1}{V_2}$$

METRIC PREFIXES

SYMBOLS

Pico	$\times 10^{-12}$	K	= Dielectric Constant	f	= frequency	L_t	= Test life
Nano	$\times 10^{-9}$	A	= Area	L	= Inductance	V_t	= Test voltage
Micro	$\times 10^{-6}$	T_D	= Dielectric thickness	δ	= Loss angle	V_o	= Operating voltage
Milli	$\times 10^{-3}$	V	= Voltage	ϕ	= Phase angle	T_t	= Test temperature
Deci	$\times 10^{-1}$	t	= time	X & Y	= exponent effect of voltage and temp.	T_o	= Operating temperature
Deca	$\times 10^{+1}$	R_s	= Series Resistance	L_o	= Operating life		
Kilo	$\times 10^{+3}$						
Mega	$\times 10^{+6}$						
Giga	$\times 10^{+9}$						
Tera	$\times 10^{+12}$						

Basic Construction – A multilayer ceramic (MLC) capacitor is a monolithic block of ceramic containing two sets of offset, interleaved planar electrodes that extend to two opposite surfaces of the ceramic dielectric. This simple

structure requires a considerable amount of sophistication, both in material and manufacture, to produce it in the quality and quantities needed in today's electronic equipment.

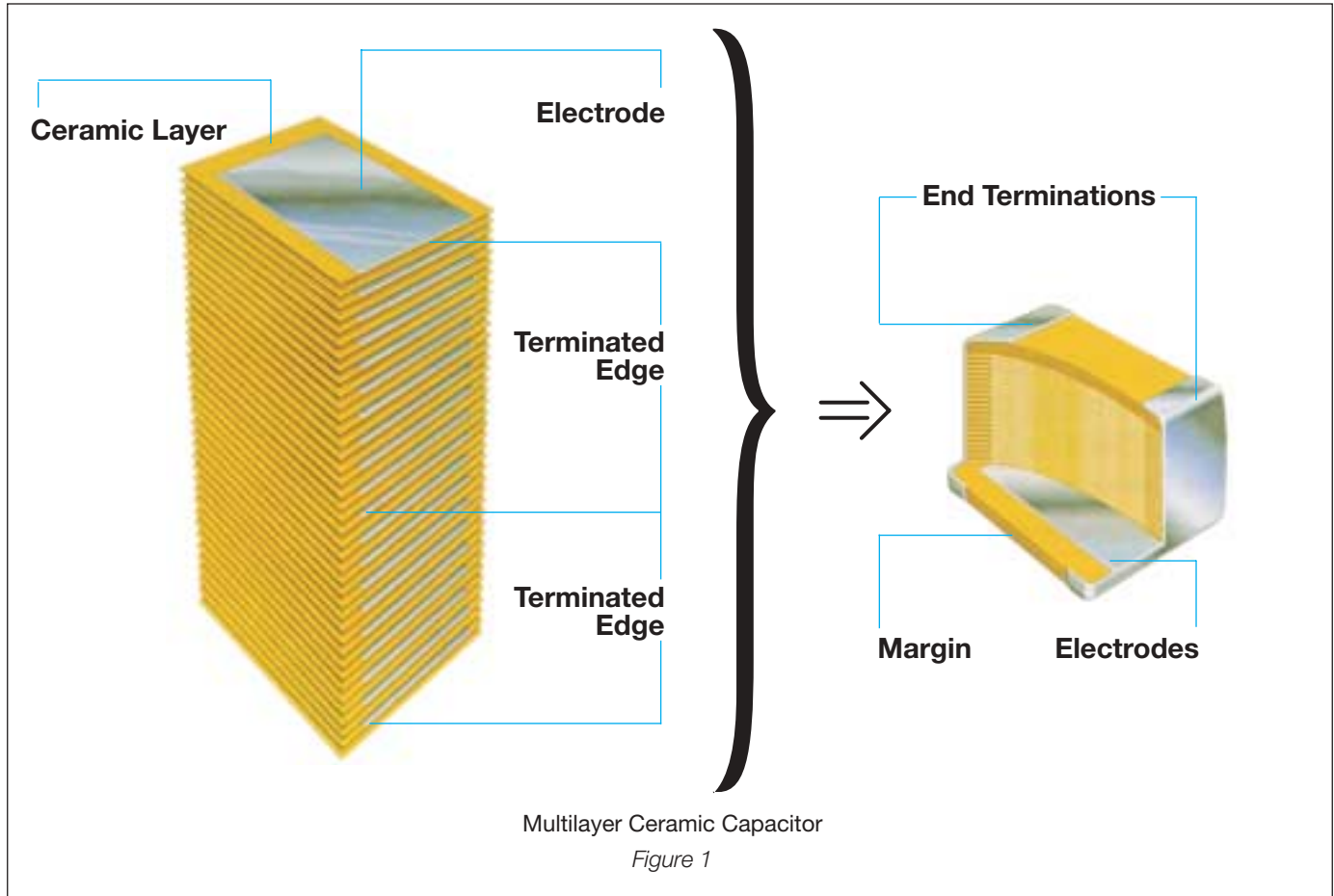

Formulations – Multilayer ceramic capacitors are available in both Class 1 and Class 2 formulations. Temperature compensating formulations are Class 1 and temperature stable and general application formulations are classified as Class 2.

Class 1 – Class 1 capacitors or temperature compensating capacitors are usually made from mixtures of titanates where barium titanate is normally not a major part of the mix. They have predictable temperature coefficients and in general, do not have an aging characteristic. Thus they are the most stable capacitor available. The most popular Class 1 multilayer ceramic capacitors are C0G (NP0) temperature compensating capacitors (negative-positive 0 ppm/°C).

Class 2 – EIA Class 2 capacitors typically are based on the chemistry of barium titanate and provide a wide range of capacitance values and temperature stability. The most commonly used Class 2 dielectrics are X7R and Y5V. The X7R provides intermediate capacitance values which vary only $\pm 15\%$ over the temperature range of -55°C to 125°C . It finds applications where stability over a wide temperature range is required.

The Y5V provides the highest capacitance values and is used in applications where limited temperature changes are expected. The capacitance value for Y5V can vary from 22% to -82% over the -30°C to 85°C temperature range. The Z5U dielectric is between X7R and Y5V in both stability and capacitance range.

All Class 2 capacitors vary in capacitance value under the influence of temperature, operating voltage (both AC and DC), and frequency. For additional information on performance changes with operating conditions, consult AVX's software, SpiCap.

Table 1: EIA and MIL Temperature Stable and General Application Codes

EIA CODE	
Percent Capacity Change Over Temperature Range	
RS198	Temperature Range
X7	-55°C to +125°C
X5	-55°C to +85°C
Y5	-30°C to +85°C
Z5	+10°C to +85°C
Code	Percent Capacity Change
D	±3.3%
E	±4.7%
F	±7.5%
P	±10%
R	±15%
S	±22%
T	+22%, -33%
U	+22%, -56%
V	+22%, -82%

EXAMPLE – A capacitor is desired with the capacitance value at 25°C to increase no more than 7.5% or decrease no more than 7.5% from -30°C to +85°C. EIA Code will be Y5F.

MIL CODE		
Symbol	Temperature Range	
A	-55°C to +85°C	
B	-55°C to +125°C	
C	-55°C to +150°C	
Symbol	Cap. Change Zero Volts	Cap. Change Rated Volts
R	+15%, -15%	+15%, -40%
W	+22%, -56%	+22%, -66%
X	+15%, -15%	+15%, -25%
Y	+30%, -70%	+30%, -80%
Z	+20%, -20%	+20%, -30%

Temperature characteristic is specified by combining range and change symbols, for example BR or AW. Specification slash sheets indicate the characteristic applicable to a given style of capacitor.

In specifying capacitance change with temperature for Class 2 materials, EIA expresses the capacitance change over an operating temperature range by a 3 symbol code. The first symbol represents the cold temperature end of the temperature range, the second represents the upper limit of the operating temperature range and the third symbol represents the capacitance change allowed over the operating temperature range. Table 1 provides a detailed explanation of the EIA system.

Effects of Voltage – Variations in voltage have little effect on Class 1 dielectric but does affect the capacitance and dissipation factor of Class 2 dielectrics. The application of DC voltage reduces both the capacitance and dissipation factor while the application of an AC voltage within a reasonable range tends to increase both capacitance and dissipation factor readings. If a high enough AC voltage is applied, eventually it will reduce capacitance just as a DC voltage will. Figure 2 shows the effects of AC voltage.

Cap. Change vs. A.C. Volts
X7R

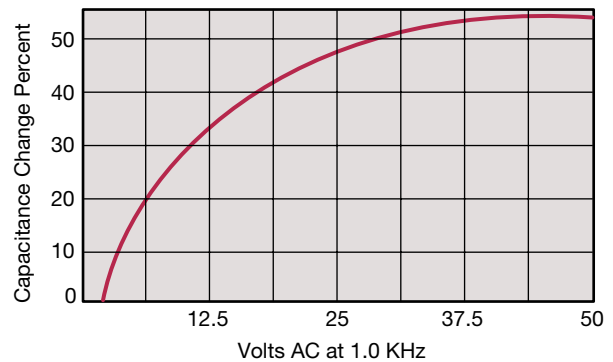

Figure 2

Capacitor specifications specify the AC voltage at which to measure (normally 0.5 or 1 VAC) and application of the wrong voltage can cause spurious readings. Figure 3 gives the voltage coefficient of dissipation factor for various AC voltages at 1 kilohertz. Applications of different frequencies will affect the percentage changes versus voltages.

D.F. vs. A.C. Measurement Volts
X7R

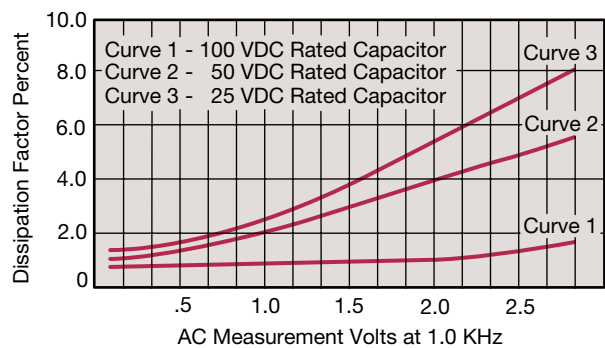

Figure 3

Typical effect of the application of DC voltage is shown in Figure 4. The voltage coefficient is more pronounced for higher K dielectrics. These figures are shown for room temperature conditions. The combination characteristic known as voltage temperature limits which shows the effects of rated voltage over the operating temperature range is shown in Figure 5 for the military BX characteristic.

**Typical Cap. Change vs. D.C. Volts
X7R**

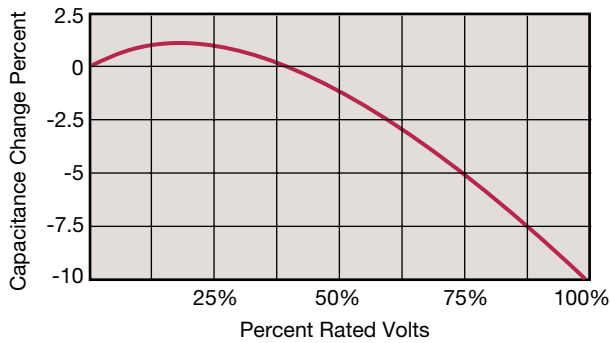

Figure 4

**Typical Cap. Change vs. Temperature
X7R**

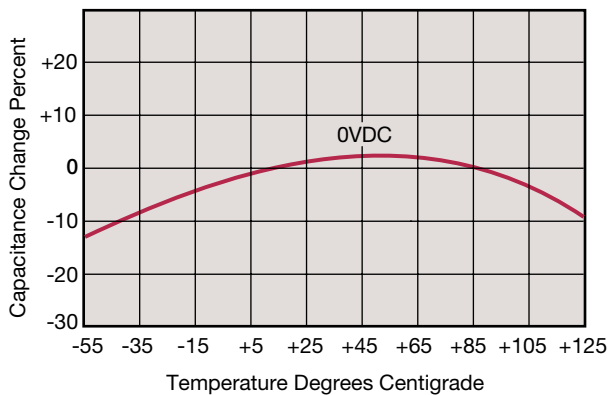

Figure 5

Effects of Time – Class 2 ceramic capacitors change capacitance and dissipation factor with time as well as temperature, voltage and frequency. This change with time is known as aging. Aging is caused by a gradual re-alignment of the crystalline structure of the ceramic and produces an exponential loss in capacitance and decrease in dissipation factor versus time. A typical curve of aging rate for semi-stable ceramics is shown in Figure 6.

If a Class 2 ceramic capacitor that has been sitting on the shelf for a period of time, is heated above its curie point, (125°C for 4 hours or 150°C for ½ hour will suffice) the part will de-age and return to its initial capacitance and dissipation factor readings. Because the capacitance changes rapidly, immediately after de-aging, the basic capacitance measurements are normally referred to a time period sometime after the de-aging process. Various manufacturers use different time bases but the most popular one is one day or twenty-four hours after “last heat.” Change in the aging curve can be caused by the application of voltage and other stresses. The possible changes in capacitance due to de-aging by heating the unit explain why capacitance changes are allowed after test, such as temperature cycling, moisture resistance, etc., in MIL specs. The application of high voltages such as dielectric withstanding voltages also

tends to de-age capacitors and is why re-reading of capacitance after 12 or 24 hours is allowed in military specifications after dielectric strength tests have been performed.

**Typical Curve of Aging Rate
X7R**

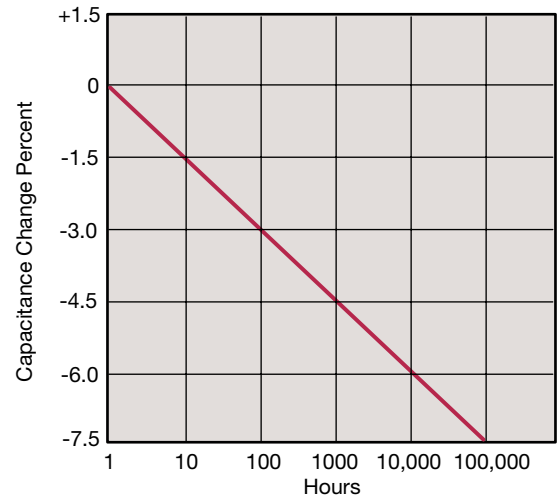

Characteristic	Max. Aging Rate %/Decade
COG (NP0)	None
X7R, X5R	2
Y5V	7

Figure 6

Effects of Frequency – Frequency affects capacitance and impedance characteristics of capacitors. This effect is much more pronounced in high dielectric constant ceramic formulation that is low K formulations. AVX’s SpiCap software generates impedance, ESR, series inductance, series resonant frequency and capacitance all as functions of frequency, temperature and DC bias for standard chip sizes and styles. It is available free from AVX and can be downloaded for free from AVX website: www.avxcorp.com.



Effects of Mechanical Stress – High “K” dielectric ceramic capacitors exhibit some low level piezoelectric reactions under mechanical stress. As a general statement, the piezoelectric output is higher, the higher the dielectric constant of the ceramic. It is desirable to investigate this effect before using high “K” dielectrics as coupling capacitors in extremely low level applications.

Reliability – Historically ceramic capacitors have been one of the most reliable types of capacitors in use today. The approximate formula for the reliability of a ceramic capacitor is:

$$\frac{L_o}{L_t} = \left(\frac{V_t}{V_o}\right)^X \left(\frac{T_t}{T_o}\right)^Y$$

where

L_o = operating life T_t = test temperature and
 L_t = test life T_o = operating temperature
 V_t = test voltage in °C
 V_o = operating voltage X, Y = see text

Historically for ceramic capacitors exponent X has been considered as 3. The exponent Y for temperature effects typically tends to run about 8.

A capacitor is a component which is capable of storing electrical energy. It consists of two conductive plates (electrodes) separated by insulating material which is called the dielectric. A typical formula for determining capacitance is:

$$C = \frac{.224 KA}{t}$$

C = capacitance (picofarads)
 K = dielectric constant (Vacuum = 1)
 A = area in square inches
 t = separation between the plates in inches
 (thickness of dielectric)
 $.224$ = conversion constant
 (.0884 for metric system in cm)

Capacitance – The standard unit of capacitance is the farad. A capacitor has a capacitance of 1 farad when 1 coulomb charges it to 1 volt. One farad is a very large unit and most capacitors have values in the micro (10^{-6}), nano (10^{-9}) or pico (10^{-12}) farad level.

Dielectric Constant – In the formula for capacitance given above the dielectric constant of a vacuum is arbitrarily chosen as the number 1. Dielectric constants of other materials are then compared to the dielectric constant of a vacuum.

Dielectric Thickness – Capacitance is indirectly proportional to the separation between electrodes. Lower voltage requirements mean thinner dielectrics and greater capacitance per volume.

Area – Capacitance is directly proportional to the area of the electrodes. Since the other variables in the equation are usually set by the performance desired, area is the easiest parameter to modify to obtain a specific capacitance within a material group.

Energy Stored – The energy which can be stored in a capacitor is given by the formula:

$$E = \frac{1}{2}CV^2$$

E = energy in joules (watts-sec)
 V = applied voltage
 C = capacitance in farads

Potential Change – A capacitor is a reactive component which reacts against a change in potential across it. This is shown by the equation for the linear charge of a capacitor:

$$I_{ideal} = C \frac{dV}{dt}$$

where

I = Current
 C = Capacitance
 dV/dt = Slope of voltage transition across capacitor

Thus an infinite current would be required to instantly change the potential across a capacitor. The amount of current a capacitor can “sink” is determined by the above equation.

Equivalent Circuit – A capacitor, as a practical device, exhibits not only capacitance but also resistance and inductance. A simplified schematic for the equivalent circuit is:

C = Capacitance L = Inductance
 R_s = Series Resistance R_p = Parallel Resistance

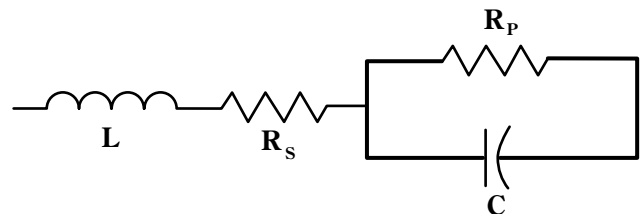

Reactance – Since the insulation resistance (R_p) is normally very high, the total impedance of a capacitor is:

$$Z = \sqrt{R_s^2 + (X_c - X_L)^2}$$

where

Z = Total Impedance
 R_s = Series Resistance
 X_c = Capacitive Reactance = $\frac{1}{2\pi fC}$
 X_L = Inductive Reactance = $2\pi fL$

The variation of a capacitor’s impedance with frequency determines its effectiveness in many applications.

Phase Angle – Power Factor and Dissipation Factor are often confused since they are both measures of the loss in a capacitor under AC application and are often almost identical in value. In a “perfect” capacitor the current in the capacitor will lead the voltage by 90°.

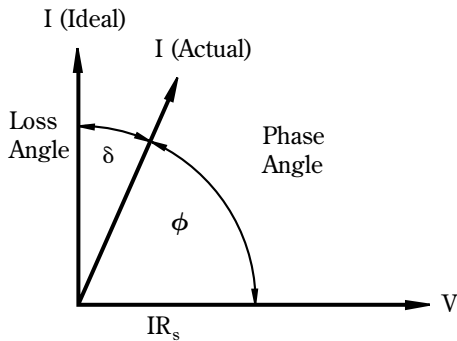

In practice the current leads the voltage by some other phase angle due to the series resistance R_s . The complement of this angle is called the loss angle and:

$$\text{Power Factor (P.F.)} = \cos \phi \text{ or } \sin \delta$$

$$\text{Dissipation Factor (D.F.)} = \tan \delta$$

for small values of δ the tan and sine are essentially equal which has led to the common interchangeability of the two terms in the industry.

Equivalent Series Resistance – The term E.S.R. or Equivalent Series Resistance combines all losses both series and parallel in a capacitor at a given frequency so that the equivalent circuit is reduced to a simple R-C series connection.

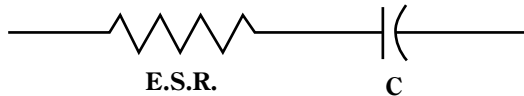

Dissipation Factor – The DF/PF of a capacitor tells what percent of the apparent power input will turn to heat in the capacitor.

$$\text{Dissipation Factor} = \frac{\text{E.S.R.}}{X_c} = (2 \pi fC) (\text{E.S.R.})$$

The watts loss are:

$$\text{Watts loss} = (2 \pi fCV^2) (\text{D.F.})$$

Very low values of dissipation factor are expressed as their reciprocal for convenience. These are called the “Q” or Quality factor of capacitors.

Parasitic Inductance – The parasitic inductance of capacitors is becoming more and more important in the decoupling of today’s high speed digital systems. The relationship between the inductance and the ripple voltage induced on the DC voltage line can be seen from the simple inductance equation:

$$V = L \frac{di}{dt}$$

The $\frac{di}{dt}$ seen in current microprocessors can be as high as 0.3 A/ns, and up to 10A/ns. At 0.3 A/ns, 100pH of parasitic inductance can cause a voltage spike of 30mV. While this does not sound very drastic, with the V_{cc} for microprocessors decreasing at the current rate, this can be a fairly large percentage.

Another important, often overlooked, reason for knowing the parasitic inductance is the calculation of the resonant frequency. This can be important for high frequency, bypass capacitors, as the resonant point will give the most signal attenuation. The resonant frequency is calculated from the simple equation:

$$f_{res} = \frac{1}{2\pi\sqrt{LC}}$$

Insulation Resistance – Insulation Resistance is the resistance measured across the terminals of a capacitor and consists principally of the parallel resistance R_P shown in the equivalent circuit. As capacitance values and hence the area of dielectric increases, the I.R. decreases and hence the product ($C \times IR$ or RC) is often specified in ohm farads or more commonly megohm-microfarads. Leakage current is determined by dividing the rated voltage by IR (Ohm’s Law).

Dielectric Strength – Dielectric Strength is an expression of the ability of a material to withstand an electrical stress. Although dielectric strength is ordinarily expressed in volts, it is actually dependent on the thickness of the dielectric and thus is also more generically a function of volts/mil.

Dielectric Absorption – A capacitor does not discharge instantaneously upon application of a short circuit, but drains gradually after the capacitance proper has been discharged. It is common practice to measure the dielectric absorption by determining the “reappearing voltage” which appears across a capacitor at some point in time after it has been fully discharged under short circuit conditions.

Corona – Corona is the ionization of air or other vapors which causes them to conduct current. It is especially prevalent in high voltage units but can occur with low voltages as well where high voltage gradients occur. The energy discharged degrades the performance of the capacitor and can in time cause catastrophic failures.

REFLOW SOLDERING

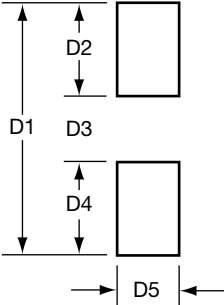

Case Size	D1	D2	D3	D4	D5
0402	1.70 (0.07)	0.60 (0.02)	0.50 (0.02)	0.60 (0.02)	0.50 (0.02)
0603	2.30 (0.09)	0.80 (0.03)	0.70 (0.03)	0.80 (0.03)	0.75 (0.03)
0805	3.00 (0.12)	1.00 (0.04)	1.00 (0.04)	1.00 (0.04)	1.25 (0.05)
1206	4.00 (0.16)	1.00 (0.04)	2.00 (0.09)	1.00 (0.04)	1.60 (0.06)
1210	4.00 (0.16)	1.00 (0.04)	2.00 (0.09)	1.00 (0.04)	2.50 (0.10)
1808	5.60 (0.22)	1.00 (0.04)	3.60 (0.14)	1.00 (0.04)	2.00 (0.08)
1812	5.60 (0.22)	1.00 (0.04)	3.60 (0.14)	1.00 (0.04)	3.00 (0.12)
1825	5.60 (0.22)	1.00 (0.04)	3.60 (0.14)	1.00 (0.04)	6.35 (0.25)
2220	6.60 (0.26)	1.00 (0.04)	4.60 (0.18)	1.00 (0.04)	5.00 (0.20)
2225	6.60 (0.26)	1.00 (0.04)	4.60 (0.18)	1.00 (0.04)	6.35 (0.25)

Dimensions in millimeters (inches)

Component Pad Design

Component pads should be designed to achieve good solder fillets and minimize component movement during reflow soldering. Pad designs are given below for the most common sizes of multilayer ceramic capacitors for both wave and reflow soldering. The basis of these designs is:

- Pad width equal to component width. It is permissible to decrease this to as low as 85% of component width but it is not advisable to go below this.
- Pad overlap 0.5mm beneath component.
- Pad extension 0.5mm beyond components for reflow and 1.0mm for wave soldering.

WAVE SOLDERING

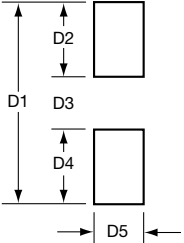

Case Size	D1	D2	D3	D4	D5
0603	3.10 (0.12)	1.20 (0.05)	0.70 (0.03)	1.20 (0.05)	0.75 (0.03)
0805	4.00 (0.15)	1.50 (0.06)	1.00 (0.04)	1.50 (0.06)	1.25 (0.05)
1206	5.00 (0.19)	1.50 (0.06)	2.00 (0.09)	1.50 (0.06)	1.60 (0.06)
1210	5.00 (0.19)	1.50 (0.06)	2.00 (0.09)	1.50 (0.06)	2.50 (0.10)

Dimensions in millimeters (inches)

Component Spacing

For wave soldering components, must be spaced sufficiently far apart to avoid bridging or shadowing (inability of solder to penetrate properly into small spaces). This is less important for reflow soldering but sufficient space must be allowed to enable rework should it be required.

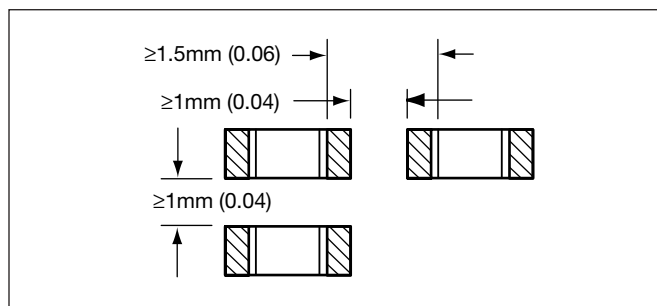

Preheat & Soldering

The rate of preheat should not exceed 4°C/second to prevent thermal shock. A better maximum figure is about 2°C/second.

For capacitors size 1206 and below, with a maximum thickness of 1.25mm, it is generally permissible to allow a temperature differential from preheat to soldering of 150°C. In all other cases this differential should not exceed 100°C.

For further specific application or process advice, please consult AVX.

Cleaning

Care should be taken to ensure that the capacitors are thoroughly cleaned of flux residues especially the space beneath the capacitor. Such residues may otherwise become conductive and effectively offer a low resistance bypass to the capacitor.

Ultrasonic cleaning is permissible, the recommended conditions being 8 Watts/litre at 20-45 kHz, with a process cycle of 2 minutes vapor rinse, 2 minutes immersion in the ultrasonic solvent bath and finally 2 minutes vapor rinse.

Surface Mounting Guide



MLC Chip Capacitors

APPLICATION NOTES

Storage

Good solderability is maintained for at least twelve months, provided the components are stored in their “as received” packaging at less than 40°C and 70% RH.

Solderability

Terminations to be well soldered after immersion in a 60/40 tin/lead solder bath at $235 \pm 5^\circ\text{C}$ for 2 ± 1 seconds.

Leaching

Terminations will resist leaching for at least the immersion times and conditions shown below.

Termination Type	Solder Tin/Lead/Silver	Solder Temp. °C	Immersion Time Seconds
Nickel Barrier	60/40/0	260 ± 5	30 ± 1

Recommended Soldering Profiles

Reflow

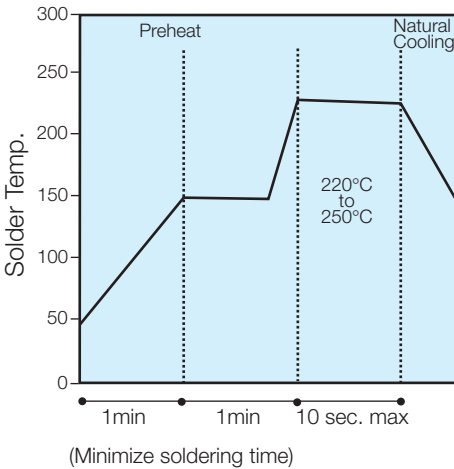

Wave

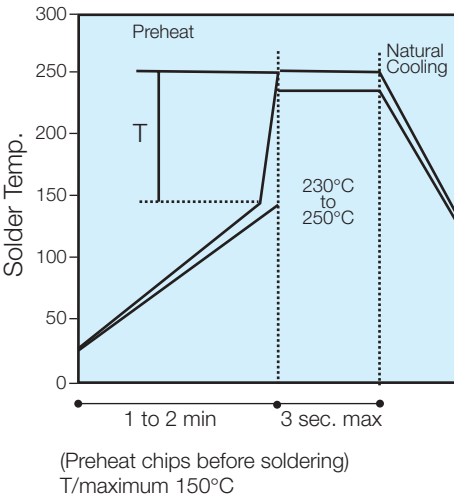

General

Surface mounting chip multilayer ceramic capacitors are designed for soldering to printed circuit boards or other substrates. The construction of the components is such that they will withstand the time/temperature profiles used in both wave and reflow soldering methods.

Handling

Chip multilayer ceramic capacitors should be handled with care to avoid damage or contamination from perspiration and skin oils. The use of tweezers or vacuum pick ups is strongly recommended for individual components. Bulk handling should ensure that abrasion and mechanical shock are minimized. Taped and reeled components provides the ideal medium for direct presentation to the placement machine. Any mechanical shock should be minimized during handling chip multilayer ceramic capacitors.

Preheat

It is important to avoid the possibility of thermal shock during soldering and carefully controlled preheat is therefore required. The rate of preheat should not exceed $4^\circ\text{C}/\text{second}$ and a target figure $2^\circ\text{C}/\text{second}$ is recommended. Although an 80°C to 120°C temperature differential is preferred, recent developments allow a temperature differential between the component surface and the soldering temperature of 150°C (Maximum) for capacitors of 1210 size and below with a maximum thickness of 1.25mm. The user is cautioned that the risk of thermal shock increases as chip size or temperature differential increases.

Soldering

Mildly activated rosin fluxes are preferred. The minimum amount of solder to give a good joint should be used. Excessive solder can lead to damage from the stresses caused by the difference in coefficients of expansion between solder, chip and substrate. AVX terminations are suitable for all wave and reflow soldering systems. If hand soldering cannot be avoided, the preferred technique is the utilization of hot air soldering tools.

Cooling

Natural cooling in air is preferred, as this minimizes stresses within the soldered joint. When forced air cooling is used, cooling rate should not exceed $4^\circ\text{C}/\text{second}$. Quenching is not recommended but if used, maximum temperature differentials should be observed according to the preheat conditions above.

Cleaning

Flux residues may be hygroscopic or acidic and must be removed. AVX MLC capacitors are acceptable for use with all of the solvents described in the specifications MIL-STD-202 and EIA-RS-198. Alcohol based solvents are acceptable and properly controlled water cleaning systems are also acceptable. Many other solvents have been proven successful, and most solvents that are acceptable to other components on circuit assemblies are equally acceptable for use with ceramic capacitors.

MLC Chip Capacitors

POST SOLDER HANDLING

Once SMP components are soldered to the board, any bending or flexure of the PCB applies stresses to the soldered joints of the components. For leaded devices, the stresses are absorbed by the compliancy of the metal leads and generally don't result in problems unless the stress is large enough to fracture the soldered connection.

Ceramic capacitors are more susceptible to such stress because they don't have compliant leads and are brittle in nature. The most frequent failure mode is low DC resistance or short circuit. The second failure mode is significant loss of capacitance due to severing of contact between sets of the internal electrodes.

Cracks caused by mechanical flexure are very easily identified and generally take one of the following two general forms:



Type A:

Angled crack between bottom of device to top of solder joint.

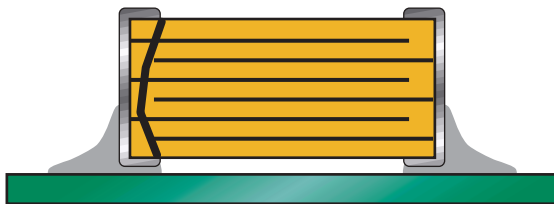

Type B:

Fracture from top of device to bottom of device.

Mechanical cracks are often hidden underneath the termination and are difficult to see externally. However, if one end termination falls off during the removal process from PCB, this is one indication that the cause of failure was excessive mechanical stress due to board warping.

COMMON CAUSES OF MECHANICAL CRACKING

The most common source for mechanical stress is board depanelization equipment, such as manual breakapart, v-cutters and shear presses. Improperly aligned or dull cutters may cause torqueing of the PCB resulting in flex stresses being transmitted to components near the board edge. Another common source of flexural stress is contact during parametric testing when test points are probed. If the PCB is allowed to flex during the test cycle, nearby ceramic capacitors may be broken.

A third common source is board to board connections at vertical connectors where cables or other PCBs are connected to the PCB. If the board is not supported during the plug/unplug cycle, it may flex and cause damage to nearby components.

Special care should also be taken when handling large (>6" on a side) PCBs since they more easily flex or warp than smaller boards.

REWORKING OF MLCs

Thermal shock is common in MLCs that are manually attached or reworked with a soldering iron. *AVX strongly recommends that any reworking of MLCs be done with hot air reflow rather than soldering irons.* It is practically impossible to cause any thermal shock in ceramic capacitors when using hot air reflow.

However direct contact by the soldering iron tip often causes thermal cracks that may fail at a later date. If rework by soldering iron is absolutely necessary, it is recommended that the wattage of the iron be less than 30 watts and the tip temperature be <300°C. *Rework should be performed by applying the solder iron tip to the pad and not directly contacting any part of the ceramic capacitor.*

Surface Mounting Guide



MLC Chip Capacitors

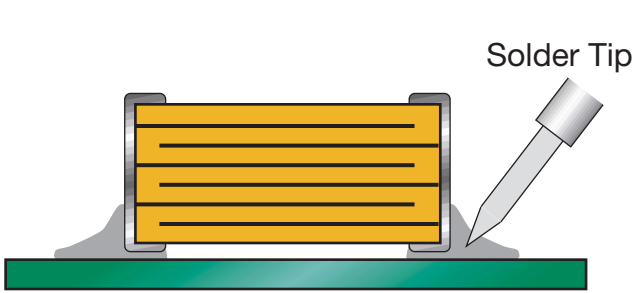

Preferred Method - No Direct Part Contact

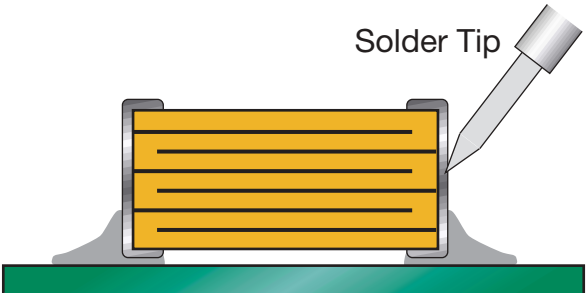

Poor Method - Direct Contact with Part

PCB BOARD DESIGN

To avoid many of the handling problems, AVX recommends that MLCs be located at least .2" away from nearest edge of board. However when this is not possible, AVX recommends that the panel be routed along the cut line, adjacent to where the MLC is located.

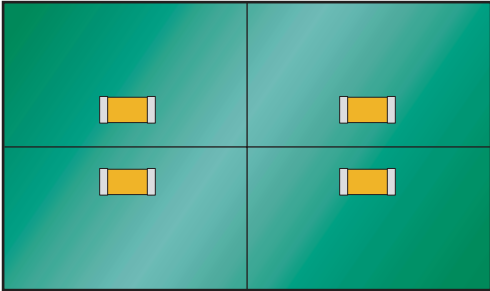

No Stress Relief for MLCs

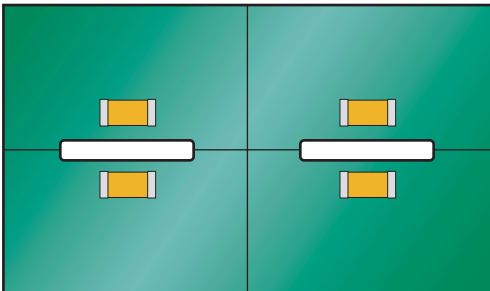

Routed Cut Line Relieves Stress on MLC



Internet/FAX/CD Rom/Software



Need Additional Information on AVX Products

Internet –

For more information visit us on the worldwide web at
<http://www.avxcorp.com>

CD ROM –

Or get in touch with your AVX representative for a CD Rom or copies of the catalogs and technical papers.

Software –

Comprehensive capacitor application software library which includes:

- SpiCap (for MLC chip capacitors)
- SpiTan (for tantalum capacitors)
- SpiCalci (for power supply capacitors)
- SpiMic (for RF-Microwave capacitors)

NOTICE: Specifications are subject to change without notice. Contact your nearest AVX Sales Office for the latest specifications. All statements, information and data given herein are believed to be accurate and reliable, but are presented without guarantee, warranty, or responsibility of any kind, expressed or implied. Statements or suggestions concerning possible use of our products are made without representation or warranty that any such use is free of patent infringement and are not recommendations to infringe any patent. The user should not assume that all safety measures are indicated or that other measures may not be required. Specifications are typical and may not apply to all applications.

© AVX Corporation



USA

AVX Myrtle Beach, SC
Corporate Offices
Tel: 843-448-9411
FAX: 843-448-1943

AVX North Central, IN
Tel: 317-848-7153
FAX: 317-844-9314

AVX Southwest, AZ
Tel: 480-539-1496
FAX: 480-539-1501

AVX Southeast, GA
Tel: 404-608-8151
FAX: 770-972-0766

AVX Northwest, WA
Tel: 360-699-8746
FAX: 360-699-8751

AVX Mid/Pacific, MN
Tel: 952-974-9155
FAX: 952-974-9179

AVX South Central, TX
Tel: 972-669-1223
FAX: 972-669-2090

AVX Canada
Tel: 905-564-8959
FAX: 905-564-9728

EUROPE

AVX Limited, England
European Headquarters
Tel: ++44 (0) 1252-770000
FAX: ++44 (0) 1252-770001

AVX/ELCO, England
Tel: ++44 (0) 1638-675000
FAX: ++44 (0) 1638-675001

AVX S.A., France
Tel: ++33 (1) 69-18-46-00
FAX: ++33 (1) 69-28-73-87

AVX GmbH, Germany
Tel: ++49 (0) 8131-9004-0
FAX: ++49 (0) 8131-9004-44

AVX srl, Italy
Tel: ++390 (0)2 614-571
FAX: ++390 (0)2 614-2576

AVX Czech Republic
Tel: ++420 (0) 465-358-111
FAX: ++420 (0) 465-323-010

ASIA-PACIFIC

AVX/Kyocera, Singapore
Asia-Pacific Headquarters
Tel: (65) 6286-7555
FAX: (65) 6488-9880

AVX/Kyocera, Hong Kong
Tel: (852) 2-363-3303
FAX: (852) 2-765-8185

AVX/Kyocera, Korea
Tel: (82) 2-785-6504
FAX: (82) 2-784-5411

AVX/Kyocera, Taiwan
Tel: (886) 2-2696-4636
FAX: (886) 2-2696-4237

AVX/Kyocera, China
Tel: (86) 21-6249-0314-16
FAX: (86) 21-6249-0313

AVX/Kyocera, Malaysia
Tel: (60) 4-228-1190
FAX: (60) 4-228-1196

Elco, Japan
Tel: 045-943-2906/7
FAX: 045-943-2910

Kyocera, Japan - AVX
Tel: (81) 75-604-3426
FAX: (81) 75-604-3425

Kyocera, Japan - KDP
Tel: (81) 75-604-3424
FAX: (81) 75-604-3425

AVX/Kyocera, Shanghai
Tel: 86-21 6886 1000
FAX: 86-21 6886 1010

Tianjin AVX/Kyocera
Tel: 86-22 2576 0098
FAX: 86-22 2576 0096

Contact:

