

KEMET











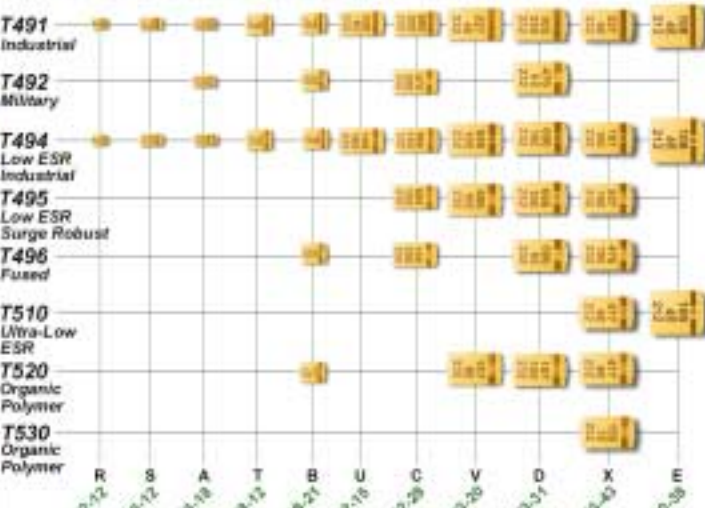

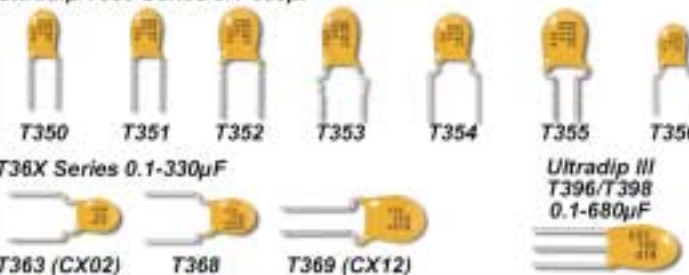
Surface Mount Capacitors

Capacitor  **dge**

www.kemet.com

F3102H 04/03

<p>ALUMINUM CHIPS AO-CAP (Surface Mounted Device) 33-470μF A700 Organic Polymer  Case Sizes - KEMET (EIA)</p>	<p>TANTALUM CHIPS (Surface Mounted Device) 0.1-1500μF T491 Industrial T492 Military T494 Low ESR Industrial T495 Low ESR Surge Robust T496 Fused T510 Ultra-Low ESR T520 Organic Polymer T530 Organic Polymer  Case Sizes - KEMET (EIA)</p>
<p>CERAMIC CHIPS (Surface Mounted Device) 0.5pF-22.0μF  *EIA Standard Style</p>	<p>CONFORMALLY COATED RADIAL Golden Max 1pF-6.8μF  C315 C320 C322 C323 C326 C330 C333 C340 C350</p> <p>CONFORMALLY COATED RADIAL Ultradip T350 Series 0.1-680μF  T350 T351 T352 T353 T354 T355 T356 T36X Series 0.1-330μF T363 (CX02) T368 T369 (CX12) Ultradip III T396/T398 0.1-680μF</p>
<p>CONFORMALLY COATED AXIAL Aximax 10pF-1μF  C410 C412 C420 C430 C440</p>	<p>MOLDED AXIAL 0.1-330μF  T322/T323 (CX01/CX05) A, B, C, D, E, & F Case Sizes</p>
<p>MOLDED RADIAL 1pF-1.0μF  C052 (CK05) (CKR05) C062 (CK06) (CKR06) C056 (CKR05) C066 (CKR06)</p>	<p>HERMETICALLY SEALED 0.0047-1200μF  T110, T140, T210(GR500), T212(CSR13), T216(CSS13), T222, T240(GR500), T242(CSR23), T252(CSR33), T256, T262(CSR21) Series</p>
<p>MOLDED AXIAL 1pF-3.3μF  C114 (CK12) (CKR11), C124 (CK13) (CKR12), C192 (CK14) (CKR14), C202 (CK15) (CKR15), C222 (CK16) (CKR16)</p>	<p>MOLDED RADIAL T330 Series 0.1-220μF T340 Series 0.1-330μF  MICRON 0.68-220μF T370 Series T378 Series (CX06) </p>

Parts shown are actual size
 Due to ever changing technology, all series may not be depicted.

SOLID TANTALUM CHIP CAPACITORS

	PAGE
GENERAL PERFORMANCE CHARACTERISTICS.....	4-14
T491 SERIES — INDUSTRIAL GRADE	15-18
T492 SERIES — CWR11 STYLE PER MIL-PRF-55365/8.....	19-20
T494 SERIES — LOW ESR, INDUSTRIAL GRADE	21-23
T495 SERIES — LOW ESR, SURGE ROBUST	24-27
T496 SERIES — FAIL-SAFE WITH BUILT-IN FUSE	28-29
T510 SERIES — ULTRA-LOW ESR	30-32

POLYMER TANTALUM CHIP CAPACITORS

	PAGE
GENERAL PERFORMANCE CHARACTERISTICS.....	33-38
T520 SERIES — KO-CAP POLYMER	39-41
T530 SERIES — KO-CAP POLYMER - MULTIPLE ANODE.....	42-43

CERAMIC CHIP CAPACITORS

	PAGE
GENERAL PERFORMANCE CHARACTERISTICS.....	44-48
CERAMIC CHIP-STANDARD	49-54
LAND DIMENSIONS	53
THICKNESS CODE REFERENCE CHART.....	54
CERAMIC CAPACITOR ARRAY	55-56
MIL-PRF-55681 ESTABLISHED RELIABILITY	57-61
MIL-PRF-55681 TAPE AND REEL QUANTITIES	61

Mil-PRF-123 and GR900 high-reliability ceramic chips are also available. Refer to KEMET Catalog F-3054 for detailed information.

TANTALUM & CERAMIC CHIP PACKAGING

	PAGE
TANTALUM CHIP PACKAGING INFORMATION.....	62
CERAMIC CHIP PACKAGING INFORMATION	63
EMBOSSED CARRIER TAPE REELING INFORMATION	64-65
PUNCHED CARRIER TAPE (PAPER TAPE) REELING INFORMATION	66
BULK CASSETTE PACKAGING	67
CERAMIC CHIP MARKING.....	67

NOTICE

Although the information in this catalog has been carefully checked for accuracy, and is believed to be correct and current, no warranty, either express or implied, is made as to either its applicability to, or its compatibility with, specific requirements; nor does KEMET Electronics Corporation assume any responsibility for correctness of this information, nor for damages consequent to its use. All design characteristics, specifications, tolerances, and the like are subject to change without notice.

NOTICE

Any capacitor misapplied may fail and there by damage other circuit components. Please refer to application notes and recommendations in this catalog for a complete description of capacitor characteristics.



ISO 9001 Registration
The quality management system for manufacture of solid tantalum chips for surface mount applications has satisfied the requirements of ISO 9001.



ISO 9001 Registration
The quality management system for the manufacture of ceramic chips for surface mount applications has satisfied the requirements of ISO 9001.

PRODUCT DESCRIPTION

KEMET's family of solid tantalum chip capacitors is designed and manufactured with the demanding requirements of surface mount technology in mind.

These devices extend the advantages of solid tantalum technology to today's surface mount circuit applications. Complementing multilayer ceramic chip convenience with capacitance ratings through 1000 μF , tantalum chip capacitors permit circuit designers to take full advantage of the benefits of surface mount technology.

T491 Series — Industrial

The leading choice in today's surface mount designs is the KEMET T491 Series. This product meets or exceeds the requirements of EIA standard 535BAAC. The physical outline and dimensions of this series conform to this global standard.

Five low profile case sizes have been added to the T491 family. The R/2012-12, S/3216-12 and T/3528-12 case sizes have a maximum height of 1.2 mm. The U/6032-15 size has a maximum height of 1.5 mm, and the V/7343-20 has a maximum height of 2.0 mm.

This product was designed specifically for today's highly automated surface mount processes and equipment. This series uses the same proven solid tantalum KEMET technology acclaimed and respected throughout the world. Added to this is the latest in materials, processes and automation which result in a component unsurpassed worldwide in total performance and value.

The standard solder-coated terminations provide excellent wetting characteristics and compatibility with today's surface mount solder systems. 100% tin terminations are available upon request for any part number. Gold-plated terminations are also available for use with conductive epoxy attachment processes. The symmetrical terminations offer total compliance to provide the thermal and mechanical stress relief required in today's technology. Lead frame attachments to the tantalum pellet are made via a microprocessor-controlled welding operation, and a high temperature silver epoxy adhesive system.

Standard packaging of these devices is tape and reel in accordance with EIA 481-1. This system provides perfect compatibility with all tape-fed placement units.

T492 Series — Military

KEMET is approved to MIL-PRF-55365/8 (CWR11), Weibull failure rate "D" level or 0.001% failures per 1,000 hours. This CWR11 product — designated as KEMET's T492 Series — is a precision-molded device, with compliant leadframe terminations and indelible laser marking. This is the military version of the global IEC/EIA standard represented by KEMET's T491 Series. Tape and reeling per EIA 481-1 is standard.

T494 Series — Low ESR, Industrial Grade

The T494 is a low ESR series that is available in all the same case sizes and CV ratings as the popular T491 series. The T494 offers low ESR performance with the economy of an industrial grade device. This series is targeted for output filtering and other applications that may benefit from improved efficiency due to low ESR.

T495 Series — Low ESR, Surge Robust

The low ESR, surge robust T495 series is an important member of KEMET's tantalum chip family. Designed primarily for output filtering in switch-mode power supplies and DC-to-DC converters, the standard CV T495 values are also an excellent choice for battery-to-ground input filter applications.

This series builds upon proven technology used for industrial grade tantalum chip capacitors to offer several important advantages: very low ESR, high ripple current capability,

excellent capacitance stability, plus improved ability to withstand high inrush currents. These benefits are achieved through a combination of proprietary design, material, and process parameters, as well as high-stress, low impedance electrical conditioning performed prior to screening. Capacitance values range from 4.7 μF to 470 μF , in voltage ratings from 6 to 50.

T496 Series — Fused

KEMET also offers a "fail-safe" fused solid tantalum chip capacitor. The built-in fuse element provides excellent protection from damaging short circuit conditions in applications where high fault currents exist. Protection from costly circuit damage due to reversed installation is offered with this device. Package sizes include the EIA standard 3528-12, 6032-15, 7343-31, and 7343-43 case size. Capacitance values range from 0.15 μF to 470.0 μF , in voltage ratings from 6 to 50. Standard capacitance tolerances include $\pm 20\%$ and $\pm 10\%$. Tape and reeling per EIA 481-1 is standard.

T510 Series — Ultra-Low ESR

The ultra-low ESR T510 Series is a breakthrough in solid tantalum capacitor technology. KEMET's T510 Series offers the low ESR in the popular EIA 7343-43 and 7360-38 case sizes. The ultra-low ESR and high ripple current capability make the T510 an ideal choice for SMPS filtering and power decoupling of today's high speed microprocessors.

KEMET has developed an innovative construction platform that incorporates multiple capacitor elements, in parallel, inside a single package. This unique assembly, combined with KEMET's superior processing technology, provides the best combination of high CV, low ESR, and small size in a user friendly, molded, surface mount package.

T520 SERIES — KO-CAP Polymer Tantalum

The KO-CAP is a Tantalum capacitor, with Ta anode and Ta₂O₅ dielectric. However, a conductive, organic, polymer replaces the MnO₂ as the cathode plate of the capacitor. This results in very low ESR and improved cap retention at high frequency. The KO-CAP also exhibits a benign failure mode, which eliminates the ignition failures that can occur in standard MnO₂ Tantalum types. Note also that KO-CAPs may be operated at voltages up to 80% of rated voltage with equivalent or better reliability than standard tantalums operated at 50% of rated voltage.

The T520 series captures the best features of multilayer ceramic caps (low ESR and high frequency cap retention), aluminum electrolytics (benign failure mode), and proven solid tantalum technology (volumetric efficiency, surface mount capability, and no wearout mechanism). The KO-CAP can reduce component counts, eliminate through-hole assembly by replacing cumbersome leaded aluminum capacitors, and offer a more cost effective solution to high-cost high-cap ceramic capacitors. These benefits allow the designer to save both board space and money. See pages 32-39 for complete details.

T530 SERIES — Organic Polymer Multiple Anode

KEMET is offering a multiple anode tantalum chip capacitor with a polymer material replacing the MnO₂ offering non-ignition, self-healing, 125°C performance capability with a higher conductivity materials that lowers the ESR. Packaged as multiple anodes to reduce depth that the signal must penetrate, this parallel arrangement reduces the ESR further still to achieve the highest capacitance and lowest ESR of any other type of SMT capacitor with typical ESR of 7 milliohms. With the reduced ESR, the enhanced capacitance retention in higher frequencies results in the lowest total capacitance solution and provides for the most economical solution in high power applications.

COMPONENT PERFORMANCE CHARACTERISTICS

Introduction

KEMET solid tantalum capacitors are identified by the initial "T," followed by a unique "Series" number; for example, T491, T492, etc. Each Series denotes a general physical form and type of encapsulation, as well as limits on dimensions and certain electrical characteristics under standard conditions of 25°C, 50% relative humidity, and one atmosphere pressure. Specific requirements are set forth in the respective Product Series in this catalog. All series are 100% screened for leakage, capacitance, dissipation factor, and ESR. All Series are inspected to electrical limits using a minimum .1% AQL sampling plan, according to the Military Standard MIL-STD-105, even after 100% testing. This sampling plan, to the best of KEMET Electronics' knowledge, meets or exceeds the generally accepted industry standard for similar products. KEMET capacitors may also be supplied, with prior agreement, to meet specifications with requirements differing from those of KEMET catalogs.

ELECTRICAL

1. General Application Class

Solid tantalum capacitors are usually applied in circuits where the AC component is small compared to the DC component. Typical uses known to KEMET Electronics include blocking, by-passing, decoupling, and filtering. They are also used in timing circuits. General purpose devices are recommended to have an external series resistance of 0.1Ω/volt to reduce the failure due to surge current. Newer devices designed for power applications (T495, T5XX), are built to eliminate this series resistance requirement. Because tantalum capacitors can experience scintillation (self-healing) in their life, the circuit impedance should not exceed 100KΩ or this will circumvent the scintillation and degrade leakage.

2. Operating Temperature Range

- -55 °C to +125 °C

Voltage derating is specified in Section 5. Performance characteristics over this temperature range are presented within the following sections.

3. Non-Operating Temperature Range

- -55 °C to +125 °C

Tantalum capacitors do not lose capacitance from the "de-forming" effect as do liquid-electrolytic capacitors. Storage at high temperature may cause a small, temporary increase in leakage current (measured under standard conditions), but the original value is usually restored within a few minutes after application of rated voltage.

Tantalum chips are not hermetically sealed, therefore they do exhibit reversible changes in parameters with respect to relative humidity (RH). Capacitance increases with increasing humidity. The limiting change, reached upon establishment

of equilibrium with the environment, is approximately -5% to +12% over the range from 25% to 95% RH, referred to the standard 50% RH. The amount of change is dependent upon size (capacitance and voltage rating, ie: CV product); small sizes might change no more than ±5%. Equilibrium at such extremes is seldom attained by plastic-cased capacitors, and the change in capacitance is consequently less. The rate of response to humidity changes increases with increasing temperature. Dissipation factor and ESR also increase with increasing RH.

DC leakage current may rise upon exposure to a combination of high temperature and high humidity, but is normally restored by voltage conditioning under standard conditions. The increase will be greater than that experienced under temperature influence alone because of conduction through absorbed water.

Tantalum chips may be affected by absorption of water on external insulating surfaces. The water film may also attract a layer of dust from the air, increasing the effect. The most sensitive parameter is leakage current.

4. Capacitance

- 0.1 μF to 1000 μF

Refer to part number tables for available capacitance ratings and tolerances by series.

Capacitance is measured at 120 Hz, up to 1.0 volt rms maximum and up to 2.5 volts DC maximum, at +25°C. DC bias causes only a small reduction in capacitance, up to about 2% when full rated voltage is applied. DC bias is not commonly used at room temperature, but is more commonly used at elevated temperatures. Capacitance decreases with increasing frequency.

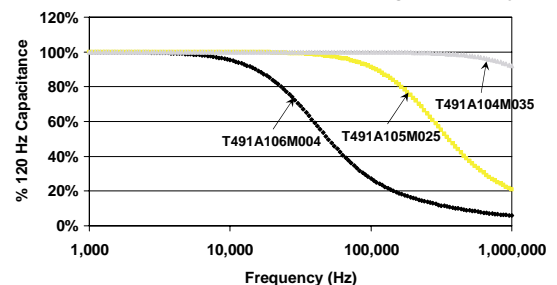

FIGURE 1 Typical Effect of Frequency upon Capacitance

Capacitance increases with increasing temperature.

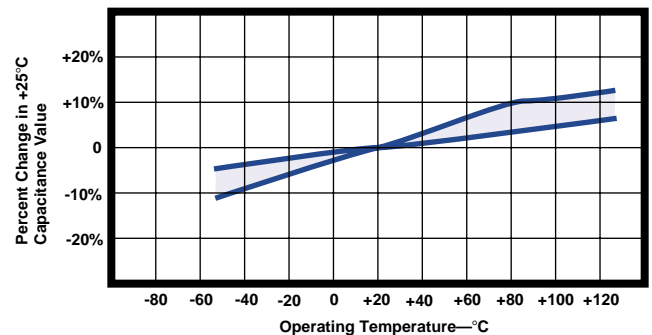

FIGURE 2 Typical Effect of Temperature upon Capacitance

COMPONENT PERFORMANCE CHARACTERISTICS (con't.)

TABLE 1 Maximum Capacitance Change with Temperature (ref: 25 °C)

Ambient Temperature		
-55°C	+85°C	+125°C
-10%	+10%	*+12% or +15%

*+12% is standard. +15% applies to certain extended CV values as noted in part number tables.

5. Working DC Voltage (WVDC)

• 3 to 50 volts

Refer to part number tables for available voltage ratings by series.

These voltages are the maximum recommended peak DC operating voltages from -55°C to +85°C for continuous duty. These voltages are derated linearly above +85°C to 2/3 rated voltage for operation at +125°C (See Figure 3). Figure 3 applies to all tantalum including the tantalum polymer series.

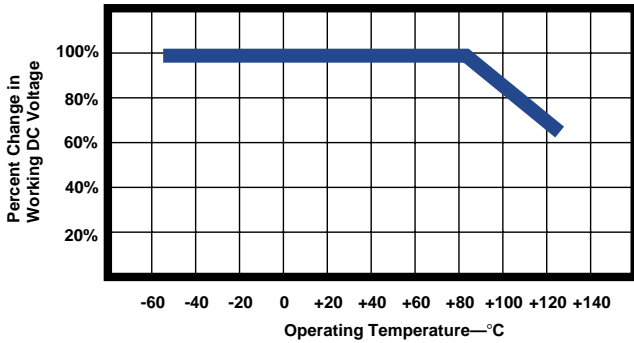

FIGURE 3 Working DC Voltage Change with Temperature

6. Surge Voltage

TABLE 2 Surge Voltage Ratings at +25°C, +85°C & +125°C

Rated Working Volts @ +25°C & +85°C	Surge Voltage @ +25°C & +85°C	Derated DC Volts @ +125°C	Surge Voltage @ +125°C
3	4	2	2.4
4	5.2	2.7	3.2
6	8	4	5
10	13	7	8
16	20	10	12
20	26	13	16
25	33	17	20
35	46	23	28
50	65	33	40

Surge voltage is the maximum voltage to which the capacitor can be subjected under transient

conditions, including the sum of peak AC ripple, DC bias and any transients.

Surge voltage tests are performed at +25°C, +85°C and +125°C with the applicable surge voltage. The surge voltage is applied for 1000 cycles of 30 seconds at voltage through a 33 ohm series resistor and 30 seconds off voltage with the capacitor discharged through a 33 ohm resistor. Upon completing the test, the capacitors are allowed to stabilize at room temperature. Capacitance, DCL and DF are then tested:

- Capacitance — within ± 5% of initial value
- DC Leakage — within initial limit
- Dissipation Factor — within initial limit
- ESR — within initial limit

7. Reverse Voltage and Polarity

TABLE 3 Reverse Voltage Ratings

Temperature	Permissible Reverse Voltage
+25°C	15% of Rated Voltage
+85°C	5% of Rated Voltage
+125°C	1% of Rated Voltage

Solid tantalum capacitors are polarized devices and may be permanently damaged or destroyed if connected with the wrong polarity. The positive terminal is identified on the capacitor body by a stripe and a beveled edge. A small degree of transient reverse voltage is permissible for short periods per Table 3. The capacitors should not be operated continuously in reverse mode, even within these limits.

8. DC Leakage Current (DCL)

Refer to part number tables for maximum leakage current limits.

DC leakage current is the current that, after a one-to five-minute charging period, flows through a capacitor when voltage is applied. Leakage is measured at +25°C with full rated DC voltage applied to the capacitor through a 1000 ohm resistor in series with the capacitor.

DC leakage current increases with increasing temperature.

TABLE 4 Leakage Limit Multipliers at Specified Temperatures (ref: 25 °C limits)

Ambient Temperature		
-55°C	+85°C	+125°C
N/A	10X	12X

COMPONENT PERFORMANCE CHARACTERISTICS (con't.)

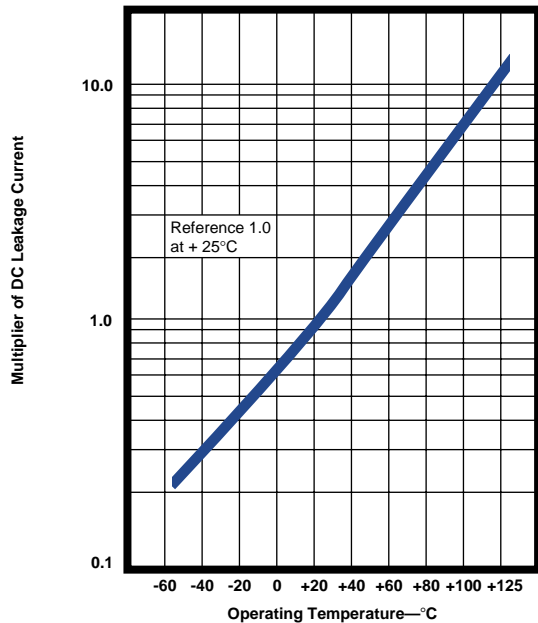

FIGURE 4 Typical Effect of Temperature upon DC Leakage Current

DC leakage current decreases with decreasing applied voltage.

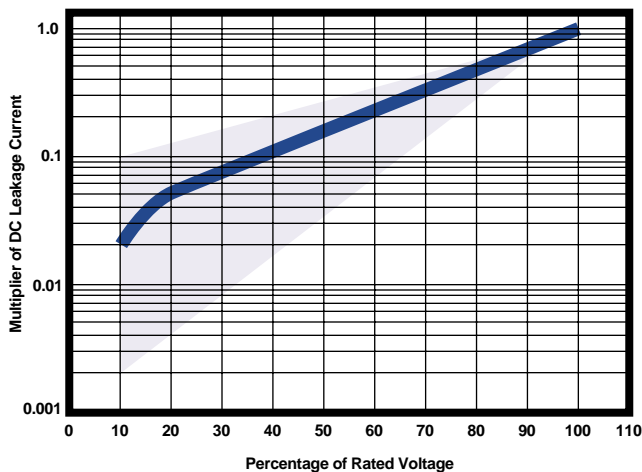

FIGURE 5 Typical Effect of Applied Voltage on DC Leakage Current.

9. Dissipation Factor (DF)

Refer to part number tables for maximum DF limits.

Dissipation factor is measured at 120 Hz, up to 1.0 volt rms maximum, and up to 2.0 volts DC maximum at +25°C. The application of DC bias causes a small reduction in DF, about 0.2% when full rated voltage is applied. DF increases with increasing frequency.

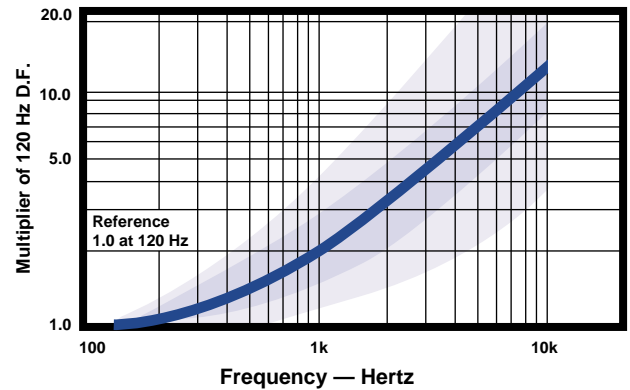

FIGURE 6 Typical Effect of Frequency upon Dissipation Factor

Dissipation factor is a very useful low frequency (120 Hz) measurement of the resistive component of a capacitor. It is the ratio of the equivalent series resistance (ESR) to the capacitive reactance, (X_c) and is usually expressed as a percentage. It is directly proportional to both capacitance and frequency. Dissipation factor loses its importance at higher frequencies, (above about 1 kHz), where impedance (Z) and equivalent series resistance (ESR) are the normal parameters of concern.

$$DF = \frac{R}{X_c} = 2\pi fCR$$

DF = Dissipation Factor
 R = Equivalent Series Resistance (Ohms)
 X_c = Capacitive Reactance (Ohms)
 f = Frequency (Hertz)
 C = Series Capacitance (Farads)

DF is also referred to as $\tan \delta$ or "loss tangent." The "Quality Factor," "Q," is the reciprocal of DF.

DF increases with temperature above +25°C and may also increase at lower temperatures. Unfortunately, one general limit for DF cannot be specified for all capacitance/voltage combinations, nor can response to temperature be simply stated. DC bias is not commonly used at room temperature, but is more commonly used at elevated temperatures.

10. Equivalent Series Resistance (ESR) and Impedance (Z)

Equivalent Series Resistance (ESR) is the preferred high-frequency statement of the resistance unavoidably appearing in these capacitors. ESR is not a pure resistance, and it decreases with increasing frequency.

Total impedance of the capacitor is the vector sum of capacitive reactance (X_c) and ESR, below resonance; above resonance total impedance is the vector sum of inductive reactance (X_L) and ESR.

COMPONENT PERFORMANCE CHARACTERISTICS (con't.)

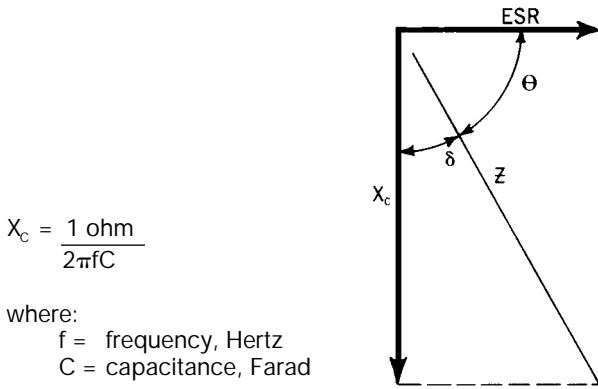

FIGURE 7a Total Impedance of the Capacitor Below Resonance

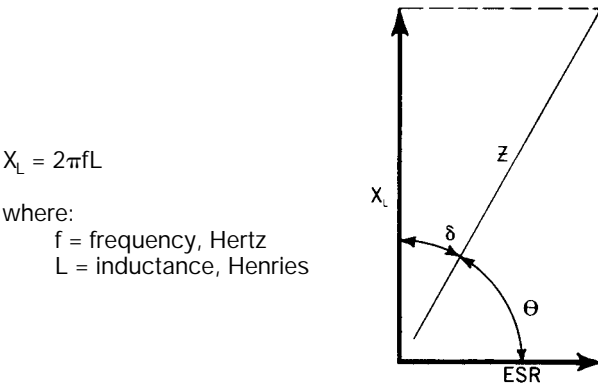

FIGURE 7b Total Impedance of the Capacitor Above Resonance

To understand the many elements of a capacitor, see Figure 8.

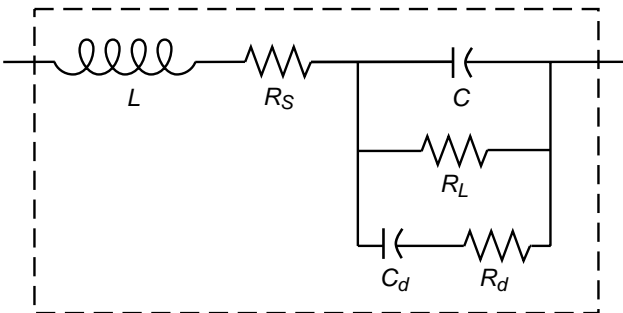

FIGURE 8 The Real Capacitor

A capacitor is a complex impedance consisting of many series and parallel elements, each adding to the complexity of the measurement system.

L — Represents lead wire and construction inductance. In most instances (especially in solid tantalum and monolithic ceramic capacitors) it is insignificant at the basic measurement frequencies of 120 and 1000 Hz.

R_s — Represents the actual ohmic series resistance in series with the capacitance. Lead wires and capacitor electrodes are contributing sources.

R_L — Capacitor Leakage Resistance. Typically it can reach 50,000 megohms in a tantalum capacitor. It can exceed 10^{12} ohms in monolithic ceramics and in film capacitors.

R_d — The dielectric loss contributed by dielectric absorption and molecular polarization. It becomes very significant in high frequency measurements and applications. Its value varies with frequency.

C_d — The inherent dielectric absorption of the solid tantalum capacitor which typically equates to 1-2% of the applied voltage.

As frequency increases, X_c continues to decrease according to its equation above. There is unavoidable inductance as well as resistance in all capacitors, and at some point in frequency, the reactance ceases to be capacitive and becomes inductive. This frequency is called the self-resonant point. In solid tantalum capacitors, the resonance is damped by the ESR, and a smooth, rather than abrupt, transition from capacitive to inductive reactance follows.

Typical ESR/Z frequency response curves are shown in Figures 9a and 9b. These curves are for selected ratings and represent typical T491 Series performance. Maximum limits for 100 kHz ESR are listed in the part number tables for each series. Note that the T494 Series offers low ESR and the T495 Series is specially designed for very low ESR performance. Refer to pages 21 and 24 for more information. See also KEMET's T510 Series low ESR ratings on page 29.

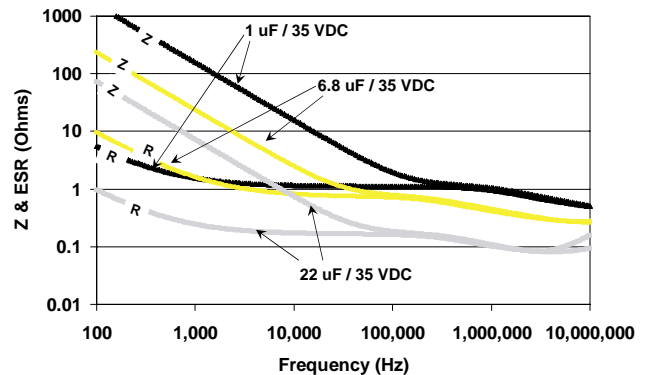

FIGURE 9a ESR & Impedance (Z) vs Frequency

COMPONENT PERFORMANCE CHARACTERISTICS (con't.)

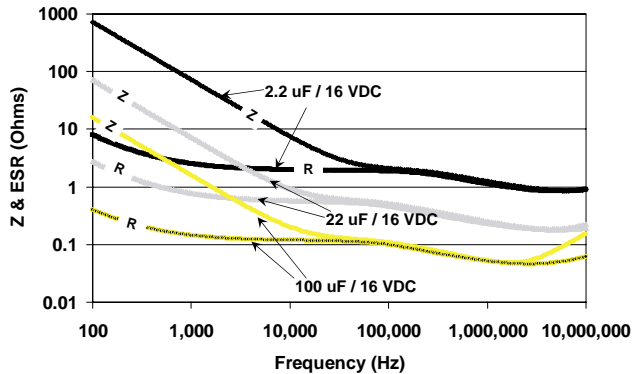

FIGURE 9b ESR & Impedance (z) vs Frequency

ESR and Z are also affected by temperature. At 100 kHz, ESR decreases with increasing temperature. The amount of change is influenced by the size of the capacitor and is generally more pronounced on smaller ratings.

Multiplier of 100kHz ESR

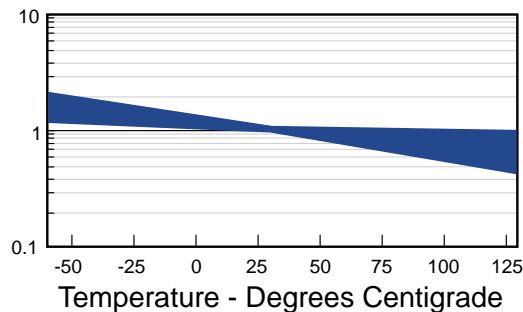

FIGURE 10 Typical Effect of Temperature on 100 kHz ESR

11. AC Power Dissipation

Power dissipation is a function of capacitor size and materials. Maximum power ratings have been established for all case sizes to prevent overheating. In actual use, the capacitor's ability to dissipate the heat generated at any given power level may be affected by a variety of circuit factors. These include board density, pad size, heat sinks and air circulation.

TABLE 5 Tantalum Chip Power Dissipation Ratings

Case Code		Maximum Power Dissipation mW @ +25°C w/+20°C Rise
KEMET	EIA	
R	2012-12	25
S	3216-12	60
T	3528-12	70
U	6032-15	90
V	7343-20	125
A	3216-18	75
B	3528-21	85
C	3062-28	110
D	7343-31	150
X	7343-43	165
E	7260-38	200
T530D	7343-31	255
T510X, T530X	7343-43	270
T510E, T530E	7260-38	285

12. AC Operation

Permissible AC ripple voltage and current are related to equivalent series resistance (ESR) and power dissipation capability.

Permissible AC ripple voltage which may be applied is limited by three criteria:

- The positive peak AC voltage plus the DC bias voltage, if any, must not exceed the DC voltage rating of the capacitor.
- The negative peak AC voltage, in combination with the bias voltage, if any, must not exceed the permissible reverse voltage ratings presented in Table 3.
- The power dissipated in the ESR of the capacitor must not exceed the appropriate value specified in Table 5.

Actual power dissipated may be calculated from the following:

$$P = I^2 R$$

$$\text{Substituting } I = \frac{E}{Z}, \quad P = \frac{E^2 R}{Z^2}$$

where:

I = rms ripple current (amperes)

E = rms ripple voltage (volts)

P = power (watts)

Z = impedance at specified frequency (ohms)

R = equivalent series resistance at specified frequency (ohms)

Using P max from Table 5, maximum allowable rms ripple current or voltage may be determined as follows:

$$I (\text{max}) = \sqrt{P \text{ max}} / R \quad E (\text{max}) = Z \sqrt{P \text{ max}} / R$$

These values should be derated at elevated temperatures as follows:

Temperature	Derating Factor
85°C	.9
125°C	.4

ENVIRONMENTAL

13. Temperature Stability

TABLE 6 Temperature Stability Limits

Step No.	Temp.	Δ Capacitance	Leakage Current	Dissipation Factor
1	+25°C	within specified tolerance	within original limit	within original limit
2	-55°C	within ± 10% of initial value	N/A	within original limit**
3	+25°C	within ± 5% of initial value	within original limit	within original limit**
4	+ 85°C	within ± 10% of initial value	within 10X original limit	within original limit***
5	+125°C	*within ± 12% or 20% of initial value	within 12X original limit	within original limit***
6	+25°C	within ± 5% of initial value	within original limit	within original limit

*+12% is standard. +15% or +20% applies to certain extended CV values as noted in part number table.

**within 1.5x initial limit for extended CV values.

***within 1.15x initial limit for extended CV values.

COMPONENT PERFORMANCE CHARACTERISTICS (con't.)

Mounted capacitors withstand extreme temperature testing at a succession of continuous steps at +25°C, -55°C, +25°C, +85°C, +125°C, +25°C, in the order stated. Capacitors shall be brought to thermal stability at each test temperature. Capacitance, DF and DCL are measured at each test temperature except that DCL is not measured at -55°C. DC bias of 2.0± 0.5 is recommended for the capacitance and D F requirements.

14. Thermal Shock

• Mil-Std-202, Method 107, Condition B

Minimum temperature -55°C, mounted

Post Test Performance:

- Capacitance — within ±5% of initial value
- DC Leakage — within initial limit
- Dissipation Factor — within initial limit
- ESR — within initial limit

15. Moisture Resistance

• Mil-Std-202, Method 106

Steps 7a and 7b excluded, rated voltage, 42 cycles, mounted

Post Test Performance:

- Capacitance — within ±10% of initial value
- DC Leakage — within initial limit
- Dissipation Factor — within initial limit
- ESR — within initial limit

16. Electrostatic Discharge (ESD)

• Human Body Model

2,000 ±50 volts, 1,500 ±5% ohms, 40 nanosecond pulse each polarity, 1 pulse each polarity, 5 seconds between pulses, +25°C.

• Charged Device Model

200 ± 5 volts, 0 ohms, 40 nanosecond pulse, each polarity, 9 pulses each polarity, 5 seconds between pulses, +25°C.

Product subjected to above test condition demonstrate *no sensitivity* to electrostatic discharge.

17. Long Term Stability

Within the general class of electrolytic capacitors, solid tantalum capacitors offer unusual stability of the three important parameters: capacitance, dissipation factor and leakage current. These solid-state devices are not subject to the effects of electrolysis, deforming or drying-out associated with liquid-electrolyte capacitors.

When stabilized for measurement at standard conditions, capacitance will typically change less than ±3% during a 10,000 hour life test +85°C.

The same comparative change has been observed in shelf tests at +25°C extending for 50,000 hours. (Some of this change may stem from instrument or fixture error.)

Dissipation factor exhibits no typical trend. Data from 10,000 hour life test at +85°C show that initial limits (at standard conditions) are not exceeded at the conclusion of these tests.

Leakage current is more variable than capacitance or DF; in fact, leakage current typically exhibits a logarithmic dependence in several respects. Military Specifications permit leakage current (measured at standard conditions) to rise by a factor of four over 10,000 hour life tests. Typical behavior shows a lower rate of change, which may be negative or positive. Initial leakage currents are frequently so low (less than 0.1 nanoampere in the smallest CV capacitors) that changes of several orders of magnitude have no discernable effect on the usual circuit designs.

18. Failure Mode

Capacitor failure may be induced by exceeding the rated conditions of forward DC voltage, reverse DC voltage, surge current, power dissipation, or temperature. As with any practical device, these capacitors also possess an inherent, although low, failure rate when operated within the rated condition.

The dominant failure mode is by short-circuit. Minor parametric drifts are of no consequence in circuits suitable for solid tantalum capacitors. Catastrophic failure occurs as an avalanche in DC leakage current over a short (millisecond) time span. The failed capacitor, while called "short-circuited", may exhibit a DC resistance of 10 to 10⁴ ohm.

If a failed capacitor is in an unprotected low-impedance circuit, continued flow of current through the capacitor may obviously produce severe overheating. The over-heated capacitor may damage the circuit board or nearby components. Protection against such occurrence is obtained by current-limiting devices or fuses provided by the circuit design. KEMET's T496 series offers a built-in fuse to convert the normal short circuit failure mode to an open circuit.

Fortunately, the inherent failure rate of KEMET solid tantalum capacitors is low, and this failure rate may be further improved by circuit design. Statistical failure rates are provided for military capacitors. Relating circuit conditions to failure rate is aided by the guides in the section following.

COMPONENT PERFORMANCE CHARACTERISTICS (con't.)

RELIABILITY

19. Reliability Prediction

Solid tantalum capacitors exhibit no degradation failure mode during shelf storage and show a constantly decreasing failure rate (i.e., absence of any wear out mechanism) during life tests. This failure rate is dependent upon three important application conditions; DC Voltage, ambient temperature, and circuit impedance. Additional effects are attributable to the capacitance of the device and atmospheric and mechanical exposure of the assembled circuit. The 1000 multiplier at the end converts the failure rate to parts-per-billion piece-hours. A prediction of the failure rate can be made using these application conditions and the formulas and tables listed in MIL-HDBK-217F (Notice 2).

Base Multiplier: The first multiplier is the base multiplier (2) established for the capacitor type. For "CWR-Chips" or surface mount components the base multiplier is 0.00005, and for "CSR-Leaded" devices, the base multiplier is 0.00040.

Temperature: The temperature factor is given as (3). From this formula, it can be seen that the unity factor, or 1, is derived at an ambient temperature of +25°C (+298°K), and that at temperatures below this the multiplier is decreasing and at temperatures above this the multiplier is increasing.

Voltage: The multiplier for application voltage (4) is a two step process: first, the application voltage is compared to 60% of rated voltage, and then this ratio is raised to an exponential power of 17 and added to unity. Consider applications of 50%, 60%, 70%, 80% and 90% of rated voltage. The multipliers for these applications would be 1.045, 2.00, 14.7, 134, and 986, respectively. From these results it is evident why manufacturers recommend application voltages not to exceed 50% rated voltages.

Capacitance: There is a factor (5) applied to the capacitance (in µF) which effectively increases the failure rate for increasing capacitance (increases in effective area resulting in increases in possible faults).

Series Resistance: The series resistance is only concerned with the resistance per application bias (ohms per volt) external to the capacitor, and does not include the ESR as a factor.

Environmental: The environmental factor is determined by the harshness of the ambient conditions beyond temperature. An explanation of these ratings is included in the MIL specification and are too extensive to be covered here. In most cases, this factor is set to ground benign or G_B, with the resulting factor equal to "1".

- (1) $\lambda_v = \lambda_b \pi_T \pi_C \pi_V \pi_{SR} \pi_Q \pi_E \times 1000$
- (2) $\lambda_b = 0.00005_{CWR} \text{ or } 0.0004_{CSR}$
- (3) $\pi_T = \exp \left[\frac{-0.15}{8.617 \cdot 10^{-5}} \left(\frac{1}{T_{Amb}} - \frac{1}{298} \right) \right]$
- (4) $S = \frac{\text{Application-Voltage}}{\text{Rated-Voltage}} \quad \pi_V = \left(\frac{S}{0.6} \right)^{17} + 1$
- (5) $\pi_C = 1.0 \cdot C^{.023}$
- (6) $\pi_{SR} = \text{Lookup Table} \quad \pi_E = \text{Lookup Table}$
- (7) $\pi_Q = \sqrt[4]{\left(\frac{\text{Pcs. Fail}}{\text{Pcs. Tested} \times \text{Hrs. Tested}} \times 100,000 \right)}$

FIGURE 11a. MIL-HDBK-217F Notice 2 formulas.

CR (ΩV)	π _{SR}
>0.8	0.66
0.6-0.8	1.0
0.4-0.6	1.3
0.2-0.4	2.0
0.1-0.2	2.7
<0.1	3.3

FIGURE 11b. Table for circuit resistance multipliers.

Quality Factor: All of these multipliers are applied to the established or base failure rate of the part. The T492 Series is qualified under U.S. military specification MIL-PRF-55365. Failure rates as low as 0.001% kWhr are available under this test program.

For series not covered by military specifications, an internal sampling program is operated by KEMET Quality Assurance whereby parts are put on life test at rated voltage for 2000 hours. The confidence level chosen for the reporting data is 60%. (The cost of sampling each batch would be prohibitive, and no claim is made to guarantee the failure rate of each batch.) With this testing and each new qualification test for new parts, the average failure rate for all commercial Series lies between 0.1% and 1.0% per thousand-piece-hours.

FIT Calculator

All of these factors are gathered into a Windows based software, available free from the KEMET web site (www.kemet.com). The "FIT Calculator" software does all the calculations and look-ups based on information entered or selected by the operator. A manual may also be downloaded from the same web page to explain the controls and displays. The manual as well as a help screen also detail the environmental conditions.

COMPONENT PERFORMANCE CHARACTERISTICS (con't.)

20. Surge Current

All conventional reliability testing is conducted under steady-state DC voltage. Experience indicates that AC ripple, within the limits prescribed, has little effect on failure rate. Heavy surge currents are possible in some applications, however. Circuit impedance may be very low (below the recommended 0.1 ohm/volt) or there may be driving inductance to cause voltage "ringing." Surge current may appear during turn-on of equipment, for example. Failure rate under current-surge conditions may not be predictable from conventional life test data.

Capacitors are capable of withstanding a 4 ±1 second charge of rated voltage (±2%) through a total circuit resistance (excluding the capacitor) of 1 ±0.2 ohms at +25°C, followed by a 4 ±1 second discharge to a voltage below 1% of the rated voltage. This cycle is repeated consecutively three (3) times. Post test performance:

- a. Capacitance — within ±5% of initial value
- b. DC Leakage — within initial limit
- c. Dissipation Factor — within initial limit

100% production surge current testing is performed on all Tantalum Chip series for case sizes C, D, E, X, U, V. The total test circuit resistance is ≤ 0.5 ohms. The applied voltage is 75% of rated voltage for all series except the T495 and T510 which are surged at 100% of rated voltage. Four surge cycles are applied. Parts not capable of surviving this test are removed at subsequent electrical screening.

21. Storage Life Test

- **2,000 hours, +125°C, Unbiased, Mounted**

Post Test Performance:

- a. Capacitance — within ±10% of initial value
- b. DC Leakage — within initial limit
- c. Dissipation Factor — within initial limit
- d. ESR — within initial limit
- e. Physical — no degradation of function

22. Standard Life Test

- **2,000 hours, +85°C, Rated Voltage, Mounted**

Post Test Performance:

- a. Capacitance — within ±10% of initial value
- b. DC Leakage — within 125% of initial limit
- c. Dissipation Factor — within initial limit
- d. ESR — within initial limit
- e. Physical — no degradation of function

23. High Temperature Life Test

- **2,000 hours, +125°C, 2/3 Rated Voltage, Mounted**

Post Test Performance:

- a. Capacitance — within ±10% of initial value
- b. DC Leakage — within 125% of initial limit
- c. Dissipation Factor — within initial limit
- d. ESR — within initial limit
- e. Physical — no degradation of function

MECHANICAL

24. Resistance to Solvents

- **Mil-Std-202, Method 215**

Post Test Performance:

- a. Capacitance — within ±10% of initial value
- b. DC Leakage — within initial limit
- c. Dissipation Factor — within initial limit
- d. Physical — no degradation of case, terminals or marking.

25. Fungus

- **Mil-Std-810, Method 508**

26. Flammability

- **UL94 VO Classification**

Encapsulant materials meet this classification.

27. Resistance to Soldering Heat

- **Wave Solder**
+260 ±5°C, 10 Seconds
- **Infrared Reflow**
+230 ±5°C, 30 Seconds
- **Vapor Phase Reflow**
+215 ±5°C, 2 minutes

Post Test Performance:

- a. Capacitance — within ±10% of Initial Value
- b. DC Leakage — within Initial Limit
- c. Dissipation Factor — within Initial Limit

28. Solderability

- **Mil-Std-202, Method 208**
- **ANSI/J-STD-002, Test B**

Applies to Solder and Tin Coated terminations only. Does not apply to optional gold-plated terminations.

29. Vibration

- **Mil-Std-202, Method 204, Condition D, 10 Hz to 2,000 Hz, 20G Peak**

Post Test Performance:

- a. Capacitance — within ± 10% of initial value
- b. DC Leakage — within initial limit
- c. Dissipation Factor — within initial limit

30. Shock

- **Mil-Std-202, Method 213, Condition I, 100 G Peak**

Post Test Performance:

- a. Capacitance — within ±10% of initial value
- b. DC Leakage — within initial limit
- c. Dissipation Factor — within initial limit

31. Terminal Strength

- **Pull Force**
• **One Pound (454 grams), 30 Seconds**

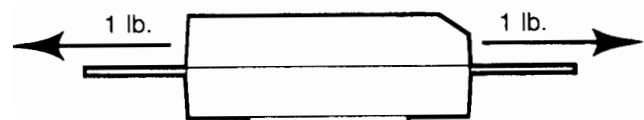

COMPONENT PERFORMANCE CHARACTERISTICS (con't.)

- **Tensile Force**
- **Four Pounds (1.8 kilograms), 60 Seconds**

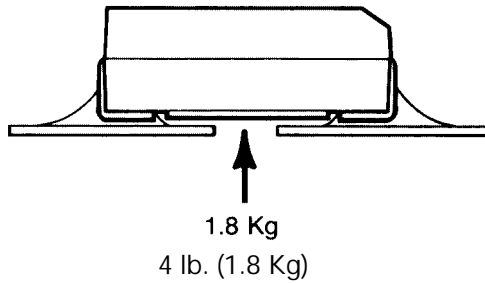

- **Shear Force**
- Table 8 Maximum Shear Loads**

Case Code		Maximum Shear Loads	
KEMET	EIA	Kilograms	Pounds
R	2012-12	2.4	5.3
S	3216-12	3.2	7.0
T	3528-12	3.6	8.0
U	6032-15	4.5	10.0
V	7343-20	5.0	11.0
A	3216-18	3.2	7.0
B	3528-21	3.6	8.0
C	6032-28	4.5	10.0
D	7343-31	5.0	11.0
X	7343-43	5.0	11.0
E	7260-38	5.0	11.0

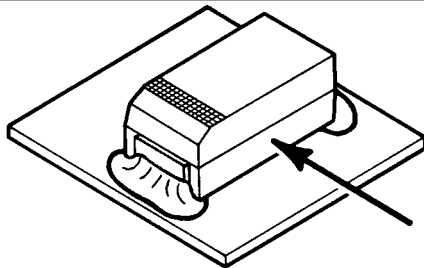

Post Test Performance:

- Capacitance — within $\pm 5\%$ of initial value
- DC Leakage — within initial limit
- Dissipation Factor — within initial limit

APPLICATIONS

32. Handling

Automatic handling of encapsulated components is enhanced by the molded case which provides compatibility with all types of high speed pick and place equipment. Manual handling of these devices presents no unique problems. Care should be taken with your fingers, however, to avoid touching the solder-coated terminations as body oils, acids and salts will degrade the solderability of these terminations. Finger cots should be used whenever manually handling all solderable surfaces.

33. Termination Coating

The standard finish coating for all molded series is 90/10 Sn/Pb solder (Tin/Lead-solder coated).

For conductive adhesive attachment processes,

a gold termination finish is available, at additional cost, on the T491, T494 and T495 Series only. The gold finish is not recommended for solder attachment.

For Pb-free soldering processes, we offer a 100% reflowed tin (Sn) termination finish.

34. Recommended Mounting Pad Geometries

Proper mounting pad geometries are essential for successful solder connections. These dimensions are highly process sensitive and should be designed to maximize the integrity of the solder joint, and to minimize component rework due to unacceptable solder joints.

Figure 12 illustrates pad geometry. Tables 9 & 10 provide recommended pad dimensions for both wave and reflow soldering techniques. These dimensions are intended to be a starting point for circuit board designers, to be fine tuned, if necessary, based upon the peculiarities of the soldering process and/or circuit board design.

Contact KEMET for Engineering Bulletin Number F-2100 entitled "Surface Mount Mounting Pad Dimensions and Considerations" for further details on this subject.

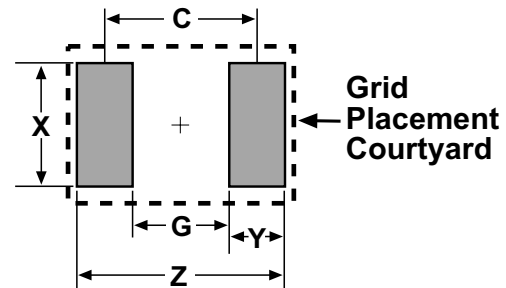

Figure 12

Table 9 – Land Pattern Dimensions for Reflow Solder

KEMET/EIA Size Code	Pad Dimensions - mm				
	Z	G	X	Y (ref)	C (ref)
R/2012-12	3.90	0.80	1.80	1.55	2.35
A/3216-18, S/3216-12	4.70	0.80	1.50	1.95	2.75
B/3528-21, T/3528-12	5.00	1.10	2.50	1.95	3.05
C/6032-28, U/6032-15	7.60	2.50	2.50	2.55	5.05
D/7343-31, V/7343-20, X/7343-43	8.90	3.80	2.70	2.55	6.35
E/7260-38	8.90	3.80	4.40	2.55	6.35

Table 10 – Land Pattern Dimensions for Wave Solder

KEMET/EIA Size Code	Pad Dimensions - mm				
	Z	G	X	Y (ref)	C (ref)
R/2012-12	4.30	0.80	1.26	1.75	2.55
A/3216-18, S/3216-12	5.10	0.80	1.10	2.15	2.95
B/3528-21, T/3528-12	5.40	1.10	1.80	2.15	3.25
C/6032-28, U/6032-15	8.00	2.50	1.80	2.75	5.25
D/7343-31, V/7343-20, X/7343-43	9.70	3.80	2.70	2.95	6.75
E/7260-38	9.70	3.80	4.40	2.95	6.75

COMPONENT PERFORMANCE CHARACTERISTICS (con't.)

35. Soldering

KEMET's families of surface mount tantalum capacitors are compatible with wave (single or dual) soldering and IR or vapor phase reflow techniques. Solder-coated terminations have excellent wetting characteristics for high integrity solder fillets. Preheating of these components is recommended to avoid extreme thermal stress. The maximum recommended preheat rate is 2°C per second. Figure 13 represents recommended maximum solder temperature / time combinations for these devices.

Note that although the X/7343-43 case size can withstand wave soldering, the tall profile (4.3mm maximum) dictates care in wave process development.

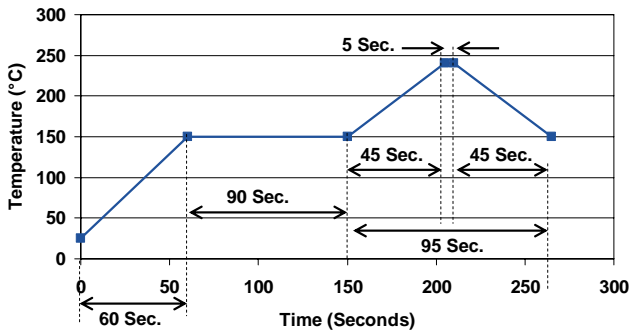

FIGURE 13 Time/Temperature Soldering Profile

Hand-soldering should be performed with care due to the difficulty in process control. If performed, care should be taken to avoid contact of the soldering iron to the molded case. The iron should be used to heat the solder pad, applying solder between the pad and the termination, until reflow occurs. The iron should be removed. "Wiping" the edges of a chip and heating the top surface is not recommended.

During typical reflow operations a slight darkening of the gold-colored epoxy may be observed.

This slight darkening is normal and is not harmful to the product. Marking permanency is not affected by this change.

36. Washing

Standard washing techniques and solvents are compatible with all KEMET surface mount tantalum capacitors. Solvents such as Freon TMC and TMS, Trichlorethane, methylene chloride, prelete, and isopropyl alcohol are not harmful to these components.

If ultrasonic agitation is utilized in the cleaning process, care should be taken to minimize energy levels and exposure times to avoid damage to the terminations.

KEMET tantalum chips are also compatible with newer aqueous and semi-aqueous processes. Please follow the recommendations for cleaning as defined by the solder vendor.

37. Encapsulations

Under normal circumstances, potting or encapsulation of KEMET tantalum chips is not required.

38. Storage Environment

Tantalum chip capacitors should be stored in normal working environments. While the chips themselves are quite robust in other environments, solderability will be degraded by exposure to high temperatures, high humidity, corrosive atmospheres, and long term storage. In addition, packaging materials will be degraded by high temperature – reels may soften or warp, and tape peel force may increase. KEMET recommends that maximum storage temperature not exceed 40 degrees C, and maximum storage humidity not exceed 60% relative humidity. In addition, temperature fluctuations should be minimized to avoid condensation on the parts, and atmospheres should be free of chlorine and sulfur bearing compounds. For optimized solderability, chip stock should be used promptly, preferably within 1.5 years of receipt.

FEATURES

- Meets or Exceeds EIA Standard 535BAAC
- Taped and Reeled per EIA 481-1
- Symmetrical, Compliant Terminations
- Optional Gold-plated Terminations
- Laser-marked Case
- 100% Surge current test on C, D, E, U, V, X sizes
- Capacitance: 0.1 μF to 1000 μF
- Tolerance: $\pm 10\%$, $\pm 20\%$
- Voltage: 3-50 VDC
- Extended Range Values
- New Low Profile Case Sizes

CAPACITOR OUTLINE DRAWING

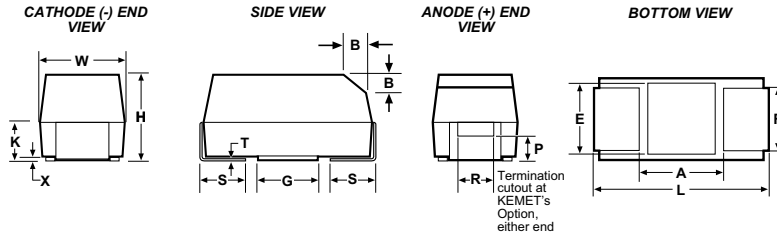

STANDARD T491 DIMENSIONS

Millimeters (inches)

CASE SIZE		COMPONENT													
KEMET	EIA	L*	W*	H*	K* ± 0.20 $\pm (.008)$	F* ± 0.1 $\pm (.004)$	S* ± 0.3 $\pm (.012)$	B ± 0.15 $(\text{Ref}) \pm (.006)$	X (Ref)	P (Ref)	R (Ref)	T (Ref)	A (Min)	G (Ref)	E (Ref)
A	3216-18	3.2 ± 0.2 (.126 $\pm .008$)	1.6 ± 0.2 (.063 $\pm .008$)	1.6 ± 0.2 (.063 $\pm .008$)	0.9 (.035)	1.2 (.047)	0.8 (.031)	0.4 (.016)	0.10 ± 0.10 (.004 $\pm .004$)	0.4 (.016)	0.4 (.016)	0.13 (.005)	0.8 (.031)	1.1 (.043)	1.3 (.051)
B	3528-21	3.5 ± 0.2 (.138 $\pm .008$)	2.8 ± 0.2 (.110 $\pm .008$)	1.9 ± 0.2 (.075 $\pm .008$)	1.1 (.043)	2.2 (.087)	0.8 (.031)	0.4 (.016)	0.10 ± 0.10 (.004 $\pm .004$)	0.5 (.020)	1.0 (.039)	0.13 (.005)	1.1 (.043)	1.8 (.071)	2.2 (.087)
C	6032-28	6.0 ± 0.3 (.236 $\pm .012$)	3.2 ± 0.3 (.126 $\pm .012$)	2.5 ± 0.3 (.098 $\pm .012$)	1.4 (.055)	2.2 (.087)	1.3 (.051)	0.5 (.020)	0.10 ± 0.10 (.004 $\pm .004$)	0.9 (.035)	1.0 (.039)	0.13 (.005)	2.5 (.098)	2.8 (.110)	2.4 (.094)
D	7343-31	7.3 ± 0.3 (.287 $\pm .012$)	4.3 ± 0.3 (.169 $\pm .012$)	2.8 ± 0.3 (.110 $\pm .012$)	1.5 (.059)	2.4 (.094)	1.3 (.051)	0.5 (.020)	0.10 ± 0.10 (.004 $\pm .004$)	0.9 (.035)	1.0 (.039)	0.13 (.005)	3.8 (.150)	3.5 (.138)	3.5 (.138)
X	7343-43	7.3 ± 0.3 (.287 $\pm .012$)	4.3 ± 0.3 (.169 $\pm .012$)	4.0 ± 0.3 (.157 $\pm .012$)	2.3 (.091)	2.4 (.094)	1.3 (.051)	0.5 (.020)	0.10 ± 0.10 (.004 $\pm .004$)	1.7 (.067)	1.0 (.039)	0.13 (.005)	3.8 (.150)	3.5** (.138)	3.5** (.138)
E	7260-38	7.3 ± 0.3 (.287 $\pm .012$)	6.0 ± 0.3 (.236 $\pm .012$)	3.6 ± 0.2 (.142 $\pm .008$)	2.3 (.091)	4.1 (.161)	1.3 (.051)	0.5 (.020)	0.10 ± 0.10 (.004 $\pm .004$)	0.9 (.035)	1.0 (.039)	0.13 (.005)	3.8 (.150)	3.5 (.138)	3.5 (.138)

- Notes: 1. Metric dimensions govern.
 2. (Ref) - Dimensions provided for reference only.
 * Mil-C-55365/8 Specified Dimensions
 ** Round Glue Pad: 2.9 ± 0.1 mm (0.114" ± 0.004 ") in diameter at KEMET's option

LOW PROFILE T491 DIMENSIONS

Millimeters (inches)

CASE SIZE		COMPONENT										
KEMET	EIA	L	W	H Max.	K Min.	F ± 0.1	S ± 0.3	X (Ref)	T (Ref)	A (Min)	G (Ref)	E (Ref)
R	2012-12	2.0 ± 0.2 (.079 $\pm .008$)	1.3 ± 0.2 (.051 $\pm .008$)	1.2 (.047)	0.3 (.012)	0.9 (.035)	0.5 (.020)	0.05 (.002)	0.13 (.005)	0.8 (.031)	0.5 (.020)	0.8 (.031)
S	3216-12	3.2 ± 0.2 (.126 $\pm .008$)	1.6 ± 0.2 (.063 $\pm .008$)	1.2 (.047)	0.3 (.012)	1.2 (.047)	0.8 (.031)	0.05 (.002)	0.13 (.005)	0.8 (.031)	1.1 (.043)	1.3 (.051)
T	3528-12	3.5 ± 0.2 (.138 $\pm .008$)	2.8 ± 0.2 (.110 $\pm .008$)	1.2 (.047)	0.3 (.012)	2.2 (.087)	0.8 (.031)	0.05 (.002)	0.13 (.005)	1.1 (.043)	1.8 (.071)	2.2 (.087)
U	6032-15	6.0 ± 0.3 (.236 $\pm .012$)	3.2 ± 0.3 (.126 $\pm .012$)	1.5 (.059)	0.5 (.020)	2.2 (.087)	1.3 (.051)	0.05 (.002)	0.13 (.005)	2.5 (.098)	2.8 (.110)	2.4 (.094)
V	7343-20	7.3 ± 0.3 (.287 $\pm .012$)	4.3 ± 0.3 (.169 $\pm .012$)	2.0 (.079)	0.9 (.035)	2.4 (.094)	1.3 (.051)	0.05 (.002)	0.13 (.005)	3.8 (.150)	3.5 (.138)	3.5 (.138)

- Notes: 1. Metric dimensions govern.
 2. (Ref) - Dimensions provided for reference only.
 3. No dimensions provided for B, P or R because low profile cases do not have a bevel or a notch.

T491 ORDERING INFORMATION

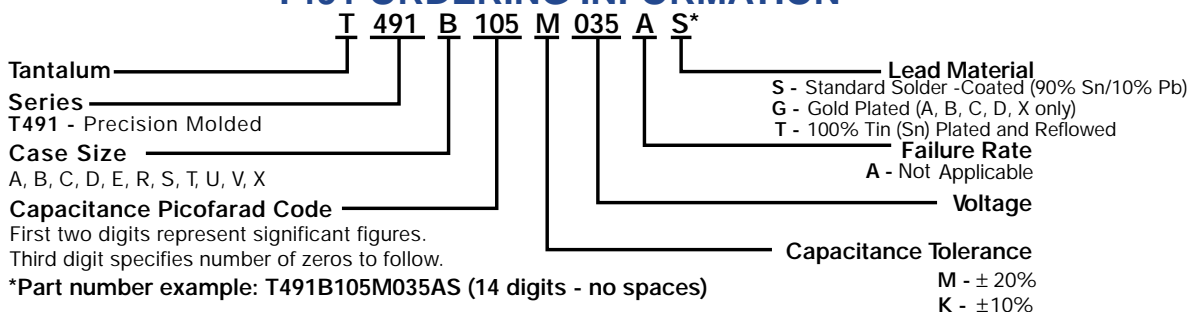

T491 TANTALUM CHIP CAPACITANCE VALUES Case Size by Capacitance and Voltage

Standard Capacitance Values

Extended Capacitance Values

Capacitance		Rated Voltage @ +85°C								Capacitance		Rated Voltage @ +85°C									
μF	Code	4	6	10	16	20	25	35	50	μF	Code	3	4	6	10	16	20	25	35	50	
0.10	104							A	A	0.10	104										
0.15	154							A	B	0.15	154										A
0.22	224							A	B	0.22	224										
0.33	334						A	A	B	0.33	334										
0.47	474						A	A/B	C	0.47	474										B
0.68	684					A	A	B	C	0.68	684									A	B
1.0	105				A	S/A	B	B	C	1.0	105						R	A	A	V	
1.5	155			A	A	S/A	B	B/C	D	1.5	155								A		C
2.2	225		A	A	S/A	A/B	B/C	C	D	2.2	225					R				B	C
3.3	335	A	A	S/A	A/B	B/T	C	C	D	3.3	335					R		A	B	B	
4.7	475	A	S/A	A/B	AB/T	B/C	C	C/D	D	4.7	475					R/S		A	B		
6.8	685	S/A	A/B	AB/T	B/C	C/U	C	D	X	6.8	685			R/S	S	A	B			C	D
10.0	106	A/B	AB/T	B/C	BCU	C/U	D	D		10.0	106		R/S	R/S	ST/A	T/A	B	C	C/V	X	
15.0	156	AB/T	B/C	BCU	C/U	D	D	X		15.0	156		S	ST/A	T/A	B	C	C	D	X	
22.0	226	B/C	BCU	C/U	C/D	D/V	D	X		22.0	226		ST/A	T/A	T/AB	U/B	C	V	D		
33.0	336	BCU	C/U	CD/V	D	D	X			33.0	336	A	T/A	T/AB	U/B	U/C	C/V	D	X		
47.0	476	C/U	C/D	D/V	D/V					47.0	476		T/AB	U/B/A	B/U/C	C	D	D/X			
68.0	686	C/D	D	D/V		X				68.0	686		U/C/A	U/C/B	U/C	V/D	D	X			
100.0	107	D	D/V	D	X					100.0	107		^B T/U/C/A	B/U/C	V/C	V/D	X				
150.0	157	D/V	D	X						150.0	157		B/C	V/C	V/CD	D/X					
220.0	227		X							220.0	227		V	C/D	D/V/X						
330.0	337									330.0	337		V/CD	D/X	D/X						
470.0	477									470.0	477		D/X	D/X	E						
680.0	687									680.0	687		D/X	E							
1000.0	108									1000.0	108		X/E								

Note that standard values are preferred. Extended values are available for use where size constraints exist. Note that standard values demonstrate inherently lower failure rates than extended values, especially in low impedance applications.

SOLID TANTALUM CHIP CAPACITORS

T491 SERIES - Precision Molded Chip



T491 RATINGS & PART NUMBER REFERENCE

Capacitance µF	Case Size	KEMET Part Number	DC Leakage mA @ +25°C Max	DF % @ +25°C 120 Hz Max	ESR W @ +25°C 100 kHz Max
3 Volt Rating at +85°C (2 Volt Rating at +125°C)					
#33.0	*A	T491A336(1)003AS	1.0	6.0	4.0
4 Volt Rating at +85°C (2.7 Volt Rating at +125°C)					
3.3	A	T491A335(1)004AS	0.5	6.0	8.0
4.7	A	T491A475(1)004AS	0.5	6.0	8.0
6.8	A	T491A685(1)004AS	0.5	6.0	6.0
6.8	S	T491S685(1)004AS	0.5	6.0	15.0
10.0	B	T491B106(1)004AS	0.5	6.0	3.5
10.0	A	T491A106(1)004AS	0.5	6.0	6.0
#10.0	*S	T491S106(1)004AS	0.5	6.0	15.0
#10.0	*R	T491R106M004AS	0.5	8.0	10.0
15.0	B	T491B156(1)004AS	0.6	6.0	3.5
15.0	A	T491A156(1)004AS	0.6	6.0	4.0
15.0	T	T491T156(1)004AS	0.6	6.0	5.0
#15.0	*S	T491S156M004AS	0.6	10.0	15.0
22.0	C	T491C226(1)004AS	0.9	6.0	1.8
22.0	B	T491B226(1)004AS	0.9	6.0	3.5
#22.0	*A	T491A226(1)004AS	0.9	6.0	4.0
#22.0	*T	T491T226(1)004AS	0.9	6.0	5.0
22.0	*S	T491S226M004AS	0.9	10.0	10.0
33.0	C	T491C336(1)004AS	1.3	6.0	1.8
33.0	U	T491U336(1)004AS	1.3	6.0	1.8
33.0	B	T491B336(1)004AS	1.3	6.0	3.5
#33.0	*A	T491A336(1)004AS	1.3	6.0	4.0
#33.0	*T	T491T336M004AS	1.3	8.0	5.0
47.0	C	T491C476(1)004AS	1.9	6.0	1.8
47.0	U	T491U476(1)004AS	1.9	6.0	1.8
#47.0	*B	T491B476(1)004AS	1.9	6.0	3.0
#47.0	*A	T491A476M004AS	1.9	12.0	2.5
#47.0	*T	T491T476M004AS	1.9	12.0	6.0
68.0	D	T491D686(1)004AS	2.7	6.0	0.8
68.0	C	T491C686(1)004AS	2.7	6.0	1.6
#68.0	*U	T491U686(1)004AS	2.7	6.0	1.8
#68.0	*B	T491B686(1)004AS	2.7	6.0	3.5
#68.0	*A	T491A686(1)004AS	2.8	30.0	4.0
100.0	D	T491D107(1)004AS	4.0	8.0	0.8
#100.0	*C	T491C107(1)004AS	4.0	8.0	1.2
#100.0	*U	T491U107(1)004AS	4.0	10.0	1.8
#100.0	*B	T491B107M004AS	4.0	8.0	1.0
#100.0	*A	T491A107M004AS	4.0	30.0	4.0
#100.0	*T	T491T107M004AS	4.0	30.0	5.0
150.0	D	T491D157(1)004AS	6.0	8.0	0.8
150.0	V	T491V157(1)004AS	6.0	8.0	0.7
#150.0	*C	T491C157(1)004AS	6.0	8.0	1.2
#150.0	*B	T491B157M004AS	6.0	12.0	2.0
#220.0	*V	T491V227(1)004AS	8.8	8.0	0.7
330.0	*D	T491D337(1)004AS	13.2	8.0	0.7
#330.0	*V	T491V337M004AS	13.2	12.0	0.7
#330.0	*C	T491C337(1)004AS	13.2	10.0	1.2
#470.0	*X	T491X477(1)004AS	18.8	8.0	0.5
#470.0	*D	T491D477(1)004AS	18.8	8.0	0.8
#680.0	*X	T491X687M004AS	27.2	12.0	0.5
#680.0	*D	T491D687M004AS	27.2	12.0	0.5
#1000.0	*X	T491X108(1)004AS	40.0	12.0	0.5
#1000.0	*E	T491E108M004AS	40.0	15.0	0.2
**6 Volt Rating at +85°C (4 Volt Rating at +125°C)					
2.2	A	T491A225(1)006AS	0.5	6.0	8.0
3.3	A	T491A335(1)006AS	0.5	6.0	8.0
4.7	A	T491A475(1)006AS	0.5	6.0	6.0
4.7	S	T491S475(1)006AS	0.5	6.0	15.0
6.8	B	T491B685(1)006AS	0.5	6.0	3.5
6.8	A	T491A685(1)006AS	0.5	6.0	6.0
#6.8	*S	T491S685(1)006AS	0.5	6.0	15.0
#6.8	*R	T491R685(1)006AS	0.5	8.0	15.0
10.0	B	T491B106(1)006AS	0.6	6.0	3.5
10.0	A	T491A106(1)006AS	0.6	6.0	4.0
10.0	T	T491T106(1)006AS	0.6	6.0	5.0
#10.0	*S	T491S106M006AS	0.6	10.0	15.0
#10.0	*R	T491R106M006AS	0.6	8.0	10.0
15.0	C	T491C156(1)006AS	0.9	6.0	1.8
15.0	B	T491B156(1)006AS	0.9	6.0	3.5
#15.0	*A	T491A156(1)006AS	0.9	6.0	4.0
#15.0	*T	T491T156(1)006AS	0.9	6.0	5.0
#15.0	*S	T491S156M006AS	0.9	10.0	10.0
22.0	C	T491C226(1)006AS	1.4	6.0	1.8
22.0	U	T491U226(1)006AS	1.4	6.0	1.8
22.0	B	T491B226(1)006AS	1.4	6.0	3.5
#22.0	*A	T491A226(1)006AS	1.4	6.0	4.0
#22.0	*T	T491T226M006AS	1.4	8.0	5.0
33.0	C	T491C336(1)006AS	2.0	6.0	1.8
33.0	U	T491U336(1)006AS	2.0	6.0	1.8
#33.0	*B	T491B336(1)006AS	2.0	6.0	3.0
#33.0	*A	T491A336M006AS	2.0	12.0	2.5
#33.0	*T	T491T336M006AS	2.0	12.0	6.0
47.0	D	T491D476(1)006AS	2.9	6.0	0.8
47.0	C	T491C476(1)006AS	2.9	6.0	1.6
#47.0	*U	T491U476(1)006AS	2.9	6.0	1.8
#47.0	*B	T491B476(1)006AS	2.9	6.0	3.5
147.0	*A	T491A476M006AS	3.0	12.0	3.5
68.0	D	T491D686(1)006AS	4.1	6.0	0.8
#68.0	*C	T491C686(1)006AS	4.1	6.0	1.2
#68.0	*U	T491U686(1)006AS	4.1	10.0	1.8
#68.0	*B	T491B686(1)006AS	4.1	8.0	1.0
100.0	D	T491D107(1)006AS	6.0	8.0	0.8
100.0	V	T491V107(1)006AS	6.0	8.0	0.7
#100.0	*C	T491C107(1)006AS	6.0	8.0	1.2
#100.0	*U	T491U107M006AS	6.0	10.0	1.8
#100.0	*B	T491B107M006AS	6.3	15.0	10.0
150.0	D	T491D157(1)006AS	9.0	8.0	0.7
#150.0	*C	T491C157M006AS	9.0	8.0	1.2
#150.0	*V	T491V157(1)006AS	9.0	8.0	0.7
220.0	X	T491X227(1)006AS	13.2	8.0	0.7
#220.0	*D	T491D227(1)006AS	13.2	8.0	0.7
#220.0	*C	T491C227M006AS	13.2	10.0	1.2
#220.0	*V	T491V227M006AS	13.2	12.0	0.7
330.0	*X	T491X337(1)006AS	19.8	8.0	0.5
330.0	*D	T491D337(1)006AS	19.8	8.0	0.5
470.0	*X	T491X477(1)006AS	28.2	10.0	0.5
470.0	*D	T491D477M006AS	28.2	12.0	0.5
680.0	*E	T491E687M006AS	40.8	12.0	0.5

Capacitance µF	Case Size	KEMET Part Number	DC Leakage mA @ 25°C Max	DF % @ +25°C 120 Hz Max	ESR W @ +25°C 100 kHz Max
10 Volt Rating at +85°C (7 Volt Rating at +125°C)					
1.5	A	T491A155(1)010AS	0.5	6.0	8.0
2.2	A	T491A225(1)010AS	0.5	6.0	8.0
3.3	A	T491A335(1)010AS	0.5	6.0	6.0
3.3	S	T491S335(1)010AS	0.5	6.0	15.0
#3.3	*R	T491R335(1)010AS	0.3	8.0	15.0
4.7	B	T491B475(1)010AS	0.5	15.0	3.5
4.7	A	T491A475(1)010AS	0.5	6.0	6.0
#4.7	*S	T491S475(1)010AS	0.5	6.0	15.0
#4.7	*R	T491R475M010AS	0.5	8.0	10.0
6.8	B	T491B685(1)010AS	0.7	6.0	3.5
6.8	A	T491A685(1)010AS	0.7	6.0	6.0
6.8	T	T491T685(1)010AS	0.7	6.0	5.0
#6.8	*S	T491S685M010AS	0.7	10.0	15.0
10.0	C	T491C106(1)010AS	1.0	6.0	1.8
10.0	B	T491B106(1)010AS	1.0	6.0	3.5
#10.0	*A	T491A106(1)010AS	1.0	6.0	4.0
#10.0	*T	T491T106(1)010AS	1.0	6.0	5.0
#10.0	*S	T491S106M010AS	1.0	10.0	15.0
15.0	C	T491C156(1)010AS	1.5	6.0	1.8
15.0	U	T491U156(1)010AS	1.5	6.0	1.8
15.0	B	T491B156(1)010AS	1.5	6.0	3.5
#15.0	*A	T491A156(1)010AS	1.5	6.0	3.5
#15.0	*T	T491T156M010AS	1.5	8.0	5.0
22.0	C	T491C226(1)010AS	2.2	6.0	1.8
22.0	U	T491U226(1)010AS	2.2	6.0	1.8
#22.0	*B	T491B226(1)010AS	2.2	6.0	3.0
#22.0	*A	T491A226M010AS	2.2	10.0	6.0
#22.0	*T	T491T226M010AS	2.2	12.0	8.0
33.0	D	T491D336(1)010AS	3.3	6.0	0.8
33.0	V	T491V336(1)010AS	3.3	6.0	0.7
33.0	C	T491C336(1)010AS	3.3	6.0	1.6
#33.0	*U	T491U336(1)010AS	3.3	6.0	1.8
#33.0	*B	T491B336(1)010AS	3.3	6.0	3.5
47.0	D	T491D476(1)010AS	4.7	6.0	0.8
47.0	V	T491V476(1)010AS	4.7	6.0	0.7
#47.0	*C	T491C476(1)010AS	4.7	6.0	1.2
#47.0	*U	T491U476(1)010AS	4.7	10.0	2.2
#47.0	*B	T491B476M010AS	4.7	8.0	1.0
68.0	D	T491D686(1)010AS	6.8	6.0	0.8
68.0	V	T491V686(1)010AS	6.8	6.0	0.7
#68.0	*C	T491C686(1)010AS	6.8	6.0	1.2
#68.0	*U	T491U686M010AS	6.8	10.0	1.8
100.0	D	T491D107(1)010AS	10.0	8.0	0.7
#100.0	*C	T491C107(1)010AS	10.0	8.0	1.2
#100.0	*V	T491V107(1)010AS	10.0	8.0	0.7
150.0	X	T491X157(1)010AS	15.0	8.0	0.7
#150.0	*D	T491D157(1)010AS	15.0	8.0	0.7
#150.0	*C	T491C157(1)010AS	15.0	10.0	1.2
#150.0	*V	T491V157M010AS	15.0	8.0	0.7
#220.0	*X	T491X227(1)010AS	22.0	8.0	0.5
#220.0	*D	T491D227(1)010AS	22.0	8.0	0.5
#220.0	*V	T491V227(1)010AS	22.0	12.0	0.7
#330.0	*D	T491D337M010AS	33.0	10.0	0.5
#330.0	*X	T491X337(1)010AS	33.0	10.0	0.5
#470.0	*E	T491E477M010AS	47.0	12.0	0.5
16 Volt Rating at +85°C (10 Volt Rating at +125°C)					
1.0	A	T491A105(1)016AS	0.5	4.0	10.0
1.5	A	T491A155(1)016AS	0.5	6.0	8.0
2.2	A	T491A225(1)016AS	0.5	6.0	6.0

T491 RATINGS & PART NUMBER REFERENCE

Capacitance μF	Case Size	KEMET Part Number	DC Leakage mA @ 25°C Max	DF % @ +25°C 120 Hz Max	ESR W @ +25°C 100 kHz Max
20 Volt Rating at +85°C (13 Volt Rating at +125°C)					
1.0	A	T491A684(1)020AS	0.5	4.0	12.0
1.0	A	T491A105(1)020AS	0.5	4.0	10.0
1.0	S	T491S105(1)020AS	0.5	6.0	18.0
#1.0	R	T491R105M020AS	0.5	6.0	20.0
1.5	A	T491A155(1)020AS	0.5	6.0	8.0
1.5	S	T491S155(1)020AS	0.5	6.0	15.0
2.2	B	T491B225(1)020AS	0.5	6.0	3.5
2.2	A	T491A225(1)020AS	0.5	6.0	7.0
3.3	B	T491B335(1)020AS	0.7	6.0	3.5
#3.3	*A	T491A335(1)020AS	0.7	6.0	7.0
3.3	*T	T491T335(1)020AS	0.7	6.0	5.0
4.7	C	T491C475(1)020AS	1.0	6.0	2.4
4.7	B	T491B475(1)020AS	1.0	6.0	3.5
#4.7	*A	T491A475M020AS	1.0	8.0	6.0
6.8	C	T491C685(1)020AS	1.4	6.0	1.9
6.8	U	T491U685(1)020AS	1.4	6.0	1.9
#6.8	*B	T491B685(1)020AS	1.4	6.0	3.5
10.0	C	T491C106(1)020AS	2.0	6.0	1.8
10.0	U	T491U106(1)020AS	2.0	6.0	1.8
#10.0	*B	T491B106(1)020AS	2.0	6.0	3.0
15.0	D	T491D156(1)020AS	3.0	6.0	1.0
15.0	*C	T491C156(1)020AS	3.0	6.0	1.7
22.0	D	T491D226(1)020AS	4.4	6.0	0.8
22.0	V	T491V226(1)020AS	4.4	6.0	0.7
#22.0	*C	T491C226(1)020AS	4.4	6.0	1.2
33.0	D	T491D336(1)020AS	6.6	6.0	0.8
#33.0	*C	T491C336M020AS	6.6	6.0	1.2
†33.0	*V	T491V336M020AS	6.6	8.0	0.7
47.0	*D	T491D476(1)020AS	9.4	6.0	0.7
68.0	X	T491X686(1)020AS	13.6	6.0	0.7
#68.0	*D	T491D686(1)020AS	13.6	8.0	0.7
#100.0	*X	T491X107(1)020AS	20.0	8.0	0.5
25 Volt Rating at +85°C (17 Volt Rating at +125°C)					
0.33	A	T491A334(1)025AS	0.5	4.0	15.0
0.47	A	T491A474(1)025AS	0.5	4.0	14.0
0.68	A	T491A684(1)025AS	0.5	4.0	10.0
1.0	B	T491B105(1)025AS	0.5	4.0	5.0
1.0	*A	T491A105(1)025AS	0.5	4.0	8.0
1.5	B	T491B155(1)025AS	0.5	6.0	5.0
1.5	*A	T491A155(1)025AS	0.5	6.0	10.0
2.2	C	T491C225(1)025AS	0.6	6.0	3.5
2.2	B	T491B225(1)025AS	0.6	6.0	4.5
3.3	C	T491C335(1)025AS	0.9	6.0	2.5
3.3	*B	T491B335(1)025AS	0.9	6.0	3.5
4.7	C	T491C475(1)025AS	1.2	6.0	2.4
#4.7	*B	T491B475M025AS	1.2	6.0	1.5
6.8	C	T491C685(1)025AS	1.7	6.0	1.9
10.0	D	T491D106(1)025AS	2.5	6.0	1.0
10.0	*C	T491C106(1)025AS	2.5	6.0	1.5
15.0	D	T491D156(1)025AS	3.8	6.0	1.0
#15.0	*C	T491C156(1)025AS	3.8	6.0	1.5
22.0	D	T491D226(1)025AS	5.5	6.0	0.8
22.0	*V	T491V226(1)025AS	5.5	6.0	0.7
33.0	X	T491X336(1)025AS	8.3	6.0	0.7
#33.0	*D	T491D336(1)025AS	8.3	6.0	0.7
#47.0	*X	T491X476(1)025AS	11.8	6.0	0.7
†47.0	*D	T491D476M025AS	11.8	10.0	0.7
†68.0	*X	T491X686M025AS	17.0	8.0	0.7

Capacitance μF	Case Size	KEMET Part Number	DC Leakage mA @ 25°C Max	DF % @ +25°C 120 Hz Max	ESR W @ +25°C 100 kHz Max
35 Volt Rating at +85°C (23 Volt Rating at +125°C)					
0.10	A	T491A104(1)035AS	0.5	4.0	20.0
0.15	A	T491A154(1)035AS	0.5	4.0	19.0
0.22	A	T491A224(1)035AS	0.5	4.0	18.0
0.33	A	T491A334(1)035AS	0.5	4.0	15.0
0.47	B	T491B474(1)035AS	0.5	4.0	8.0
0.47	A	T491A474(1)035AS	0.5	4.0	14.0
0.68	B	T491B684(1)035AS	0.5	4.0	6.5
0.68	*A	T491A684(1)035AS	0.5	4.0	10.0
1.0	B	T491B105(1)035AS	0.5	4.0	5.0
1.0	*A	T491A105(1)035AS	0.5	4.0	10.0
1.5	C	T491C155(1)035AS	0.5	6.0	4.5
1.5	B	T491B155(1)035AS	0.5	6.0	5.0
2.2	C	T491C225(1)035AS	0.8	6.0	3.5
2.2	*B	T491B225(1)035AS	0.8	6.0	4.0
3.3	C	T491C335(1)035AS	1.2	6.0	2.5
#3.3	*B	T491B335M035AS	1.2	6.0	3.5
4.7	D	T491D475(1)035AS	1.7	6.0	1.5
4.7	C	T491C475(1)035AS	1.7	6.0	2.5
6.8	D	T491D685(1)035AS	2.4	6.0	1.3
6.8	*C	T491C685(1)035AS	2.4	6.0	2.0
10.0	D	T491D106(1)035AS	3.5	6.0	1.0
#10.0	*C	T491C106M035AS	3.5	6.0	2.0
#10.0	*V	T491V106(1)035AS	3.5	6.0	2.0
15.0	X	T491X156(1)035AS	5.3	6.0	0.9
15.0	*D	T491D156(1)035AS	5.3	6.0	0.8
22.0	X	T491X226(1)035AS	7.7	6.0	0.7
#22.0	*D	T491D226(1)035AS	7.7	6.0	0.7
#33.0	*X	T491X336(1)035AS	11.6	6.0	0.6
#47.0	*X	T491X476(1)035AS	16.5	8.0	0.6
50 Volt Rating at +85°C (33 Volt Rating at +125°C)					
0.10	A	T491A104(1)050AS	0.5	4.0	20.0
0.15	B	T491B154(1)050AS	0.5	4.0	16.0
0.15	*A	T491A154(1)050AS	0.5	4.0	19.0
0.22	B	T491B224(1)050AS	0.5	4.0	14.0
0.33	B	T491B334(1)050AS	0.5	4.0	10.0
0.47	C	T491C474(1)050AS	0.5	4.0	8.0
0.47	*B	T491B474(1)050AS	0.5	4.0	9.0
0.68	C	T491C684(1)050AS	0.5	4.0	7.0
0.68	*B	T491B684(1)050AS	0.5	4.0	8.0
1.0	C	T491C105(1)050AS	0.5	4.0	5.5
1.0	*V	T491V105M050AS	0.5	4.0	6.0
1.5	D	T491D155(1)050AS	0.8	6.0	3.5
1.5	*C	T491C155(1)050AS	0.8	6.0	4.5
2.2	D	T491D225(1)050AS	1.1	6.0	2.5
2.2	*C	T491C225(1)050AS	1.1	6.0	3.5
3.3	D	T491D335(1)050AS	1.7	6.0	2.0
4.7	D	T491D475(1)050AS	2.4	6.0	1.5
6.8	X	T491X685(1)050AS	3.5	6.0	1.0
#6.8	*D	T491D685M050AS	3.4	6.0	1.0
#10.0	*X	T491X106M050AS	5.0	6.0	0.7
#15.0	*X	T491X156(1)050AS	7.5	8.0	0.7

*Extended Values

**6 Volt product equivalent to 6.3 volt product.

(1) To complete KEMET Part Number, insert M for $\pm 20\%$ tolerance or K for $\pm 10\%$ tolerance.

Higher voltage ratings, lower ESR, and tighter capacitance tolerance product may be substituted within the same size at KEMET's option. Voltage substitutions will be marked with the higher voltage rating.

#Maximum Capacitance Change @ 125°C= $\pm 15\%$.

†Maximum Capacitance Change @ 125°C= $\pm 20\%$.

New values are in red.

CAPACITOR MARKINGS

T491 Series — All Case Sizes

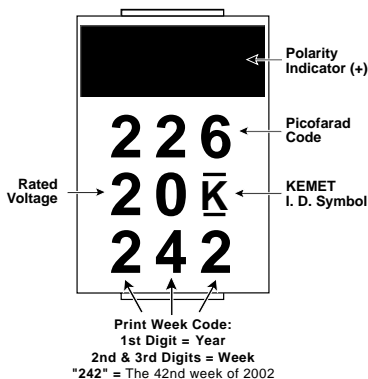

CONSTRUCTION

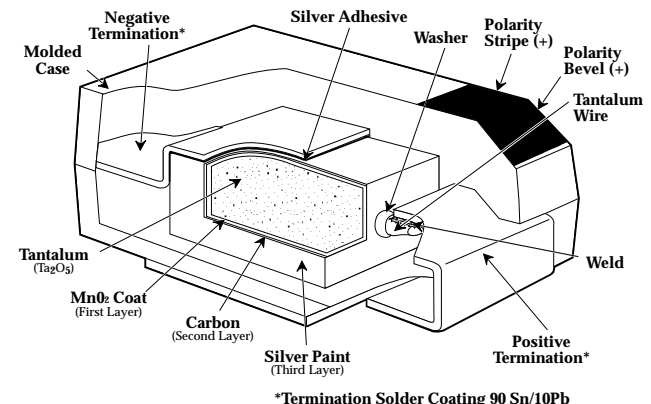

SOLID TANTALUM CHIP CAPACITORS

T492 SERIES—Style CWR11 Per Mil-PRF-55365/8



- Established reliability military version of Industrial Grade T491 series
- Taped and reeled per EIA 481-1
- Precision-molded, laser-marked case
- Symmetrical, compliant terminations
- 100% Surge Current test on C, D sizes
- Qualified to MIL-PRF-55365/8, Style CWR11:
 - Termination Code H, solder-plated
 - Weibull failure rate codes B, C and D
 - Capacitance values and voltages as shown in following part number table. (Contact KEMET for latest qualification status)

T492 OUTLINE DRAWINGS

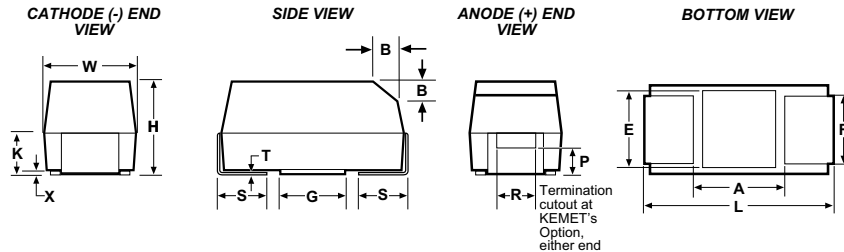

DIMENSIONS – Millimeters (Inches)

CASE SIZE		COMPONENT													
KEMET	EIA	L*	W*	H*	K* ±0.20 ±(.008)	F* ±0.1 ±(.004)	S* ±0.3 ±(.012)	B ±0.15 (Ref) ± (.006)	X (Ref)	P (Ref)	R (Ref)	T (Ref)	A (Min)	G (Ref)	E (Ref)
A	3216-18	3.2 ± 0.2 (.126 ± .008)	1.6 ± 0.2 (.063 ± .008)	1.6 ± 0.2 (.063 ± .008)	0.9 (.035)	1.2 (.047)	0.8 (.031)	0.4 (.016)	0.10 ± 0.10 (.004 ± .004)	0.4 (.016)	0.4 (.016)	0.13 (.005)	0.8 (.031)	1.1 (.043)	1.3 (.051)
B	3528-21	3.5 ± 0.2 (.138 ± .008)	2.8 ± 0.2 (.110 ± .008)	1.9 ± 0.2 (.075 ± .008)	1.1 (.043)	2.2 (.087)	0.8 (.031)	0.4 (.016)	0.10 ± 0.10 (.004 ± .004)	0.5 (.020)	1.0 (.039)	0.13 (.005)	1.1 (.043)	1.8 (.071)	2.2 (.087)
C	6032-28	6.0 ± 0.3 (.236 ± .012)	3.2 ± 0.3 (.126 ± .012)	2.5 ± 0.3 (.098 ± .012)	1.4 (.055)	2.2 (.087)	1.3 (.051)	0.5 (.020)	0.10 ± 0.10 (.004 ± .004)	0.9 (.035)	1.0 (.039)	0.13 (.005)	2.5 (.098)	2.8 (.110)	2.4 (.094)
D	7343-31	7.3 ± 0.3 (.287 ± .012)	4.3 ± 0.3 (.169 ± .012)	2.8 ± 0.3 (.110 ± .012)	1.5 (.059)	2.4 (.094)	1.3 (.051)	0.5 (.020)	0.10 ± 0.10 (.004 ± .004)	0.9 (.035)	1.0 (.039)	0.13 (.005)	3.8 (.150)	3.5 (.138)	3.5 (.138)

Notes: 1. Metric dimensions govern. * Mil-C-55365/8 Specified Dimensions
 2. (Ref) - Dimensions provided for reference only.

ORDERING INFORMATION — MIL-PRF-55365 Part Number

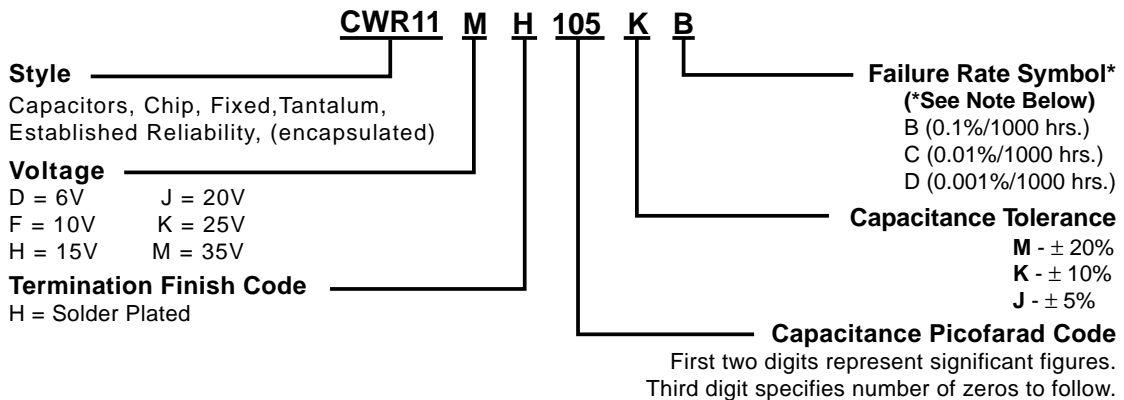

T492 SERIES ORDERING INFORMATION — KEMET Part Number

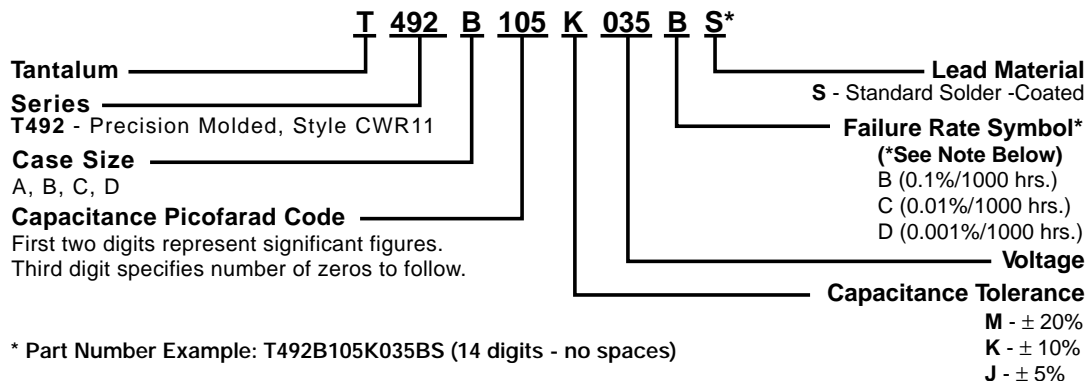

*Note on Failure Rates: Exponential failure rate levels M, P, R and S are inactive for new design per Mil-C-55365. Parts qualified to Weibull failure rate levels are substitutable for exponential failure rate levels.

T492 (CWR11) RATINGS AND PART NUMBER REFERENCE

Capacitance μF	Case Size	KEMET Part Number	Mil-C-55365/8 Part Number	DC Leakage μA @ +25°C Max	DF % @ +25°C 120 Hz Max	ESR Ω @ +25°C 100kHz Max
6 Volt Rating at +85°C (4 Volt Rating at +125°C)						
1.5	A	T492A155(1)006(2)S	CWR11DH155(1)(2)	0.5	6.0	8.0
2.2	A	T492A225(1)006(2)S	CWR11DH225(1)(2)	0.5	6.0	8.0
3.3	A	T492A335(1)006(2)S	CWR11DH335(1)(2)	0.5	6.0	8.0
4.7	B	T492B475(1)006(2)S	CWR11DH475(1)(2)	0.5	6.0	5.5
6.8	B	T492B685(1)006(2)S	CWR11DH685(1)(2)	0.5	6.0	4.5
10.0	B	T492B106(1)006(2)S	CWR11DH106(1)(2)	0.6	6.0	3.5
15.0	C	T492C156(1)006(2)S	CWR11DH156(1)(2)	0.9	6.0	3.0
22.0	C	T492C226(1)006(2)S	CWR11DH226(1)(2)	1.4	6.0	2.2
47.0	D	T492D476(1)006(2)S	CWR11DH476(1)(2)	2.8	6.0	1.1
10 Volt Rating at +85°C (7 Volt Rating at 125°C)						
1.0	A	T492A105(1)010(2)S	CWR11FH105(1)(2)	0.5	4.0	10.0
1.5	A	T492A155(1)010(2)S	CWR11FH155(1)(2)	0.5	6.0	8.0
2.2	A	T492A225(1)010(2)S	CWR11FH225(1)(2)	0.5	6.0	8.0
3.3	B	T492B335(1)010(2)S	CWR11FH335(1)(2)	0.5	6.0	5.5
4.7	B	T492B475(1)010(2)S	CWR11FH475(1)(2)	0.5	6.0	4.5
6.8	B	T492B685(1)010(2)S	CWR11FH685(1)(2)	0.7	6.0	3.5
15.0	C	T492C156(1)010(2)S	CWR11FH156(1)(2)	1.5	6.0	2.5
33.0	D	T492D336(1)010(2)S	CWR11FH336(1)(2)	3.3	6.0	1.1
15 Volt Rating at +85°C (10 Volt Rating at +125°C)						
0.68	A	T492A684(1)015(2)S	CWR11HH684(1)(2)	0.5	4.0	12.0
1.0	A	T492A105(1)015(2)S	CWR11HH105(1)(2)	0.5	4.0	10.0
1.5	A	T492A155(1)015(2)S	CWR11HH155(1)(2)	0.5	6.0	8.0
2.2	B	T492B225(1)015(2)S	CWR11HH225(1)(2)	0.5	6.0	5.5
3.3	B	T492B335(1)015(2)S	CWR11HH335(1)(2)	0.5	6.0	5.0
4.7	B	T492B475(1)015(2)S	CWR11HH475(1)(2)	0.7	6.0	4.0
10.0	C	T492C106(1)015(2)S	CWR11HH106(1)(2)	1.6	6.0	2.5
22.0	D	T492D226(1)015(2)S	CWR11HH226(1)(2)	3.3	6.0	1.1
20 Volt Rating at +85°C (13 Volt Rating at +125°C)						
0.47	A	T492A474(1)020(2)S	CWR11JH474(1)(2)	0.5	4.0	14.0
0.68	A	T492A684(1)020(2)S	CWR11JH684(1)(2)	0.5	4.0	12.0
1.0	A	T492A105(1)020(2)S	CWR11JH105(1)(2)	0.5	4.0	10.0
1.5	B	T492B155(1)020(2)S	CWR11JH155(1)(2)	0.5	6.0	6.0
2.2	B	T492B225(1)020(2)S	CWR11JH225(1)(2)	0.5	6.0	5.0
3.3	B	T492B335(1)020(2)S	CWR11JH335(1)(2)	0.7	6.0	4.0
4.7	C	T492C475(1)020(2)S	CWR11JH475(1)(2)	1.0	6.0	3.0
6.8	C	T492C685(1)020(2)S	CWR11JH685(1)(2)	1.4	6.0	2.4
15.0	D	T492D156(1)020(2)S	CWR11JH156(1)(2)	3.0	6.0	1.1
25 Volt Rating at +85°C (17 Volt Rating at +125°C)						
0.33	A	T492A334(1)025(2)S	CWR11KH334(1)(2)	0.5	4.0	15.0
0.47	A	T492A474(1)025(2)S	CWR11KH474(1)(2)	0.5	4.0	14.0
0.68	B	T492B684(1)025(2)S	CWR11KH684(1)(2)	0.5	4.0	7.5
1.0	B	T492B105(1)025(2)S	CWR11KH105(1)(2)	0.5	4.0	6.5
1.5	B	T492B155(1)025(2)S	CWR11KH155(1)(2)	0.5	6.0	6.5
2.2	C	T492C225(1)025(2)S	CWR11KH225(1)(2)	0.6	6.0	3.5
3.3	C	T492C335(1)025(2)S	CWR11KH335(1)(2)	0.9	6.0	3.5
4.7	C	T492C475(1)025(2)S	CWR11KH475(1)(2)	1.2	6.0	2.5
6.8	D	T492D685(1)025(2)S	CWR11KH685(1)(2)	1.7	6.0	1.4
10.0	D	T492D106(1)025(2)S	CWR11KH106(1)(2)	2.5	6.0	1.2
35 Volt Rating at +85°C (23 Volt Rating at +125°C)						
0.10	A	T492A104(1)035(2)S	CWR11MH104(1)(2)	0.5	4.0	24.0
0.15	A	T492A154(1)035(2)S	CWR11MH154(1)(2)	0.5	4.0	21.0
0.22	A	T492A224(1)035(2)S	CWR11MH224(1)(2)	0.5	4.0	18.0
0.33	A	T492A334(1)035(2)S	CWR11MH334(1)(2)	0.5	4.0	15.0
0.47	B	T492B474(1)035(2)S	CWR11MH474(1)(2)	0.5	4.0	10.0
0.68	B	T492B684(1)035(2)S	CWR11MH684(1)(2)	0.5	4.0	8.0
1.0	B	T492B105(1)035(2)S	CWR11MH105(1)(2)	0.5	4.0	6.5
1.5	C	T492C155(1)035(2)S	CWR11MH155(1)(2)	0.5	6.0	4.5
2.2	C	T492C225(1)035(2)S	CWR11MH225(1)(2)	0.8	6.0	3.5
3.3	C	T492C335(1)035(2)S	CWR11MH335(1)(2)	1.2	6.0	2.5
4.7	D	T492D475(1)035(2)S	CWR11MH475(1)(2)	1.7	6.0	1.5

CONSTRUCTION

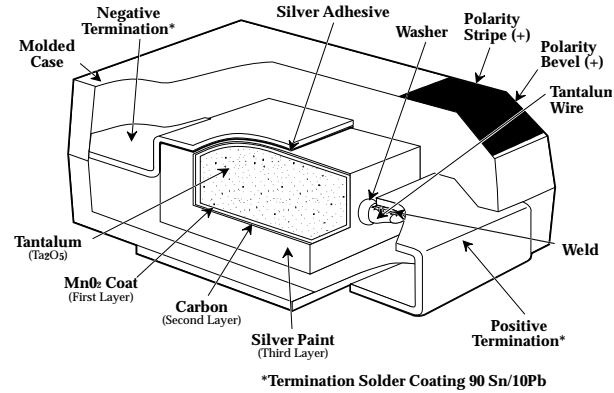

CAPACITOR MARKINGS

T492 Series — All Case Sizes

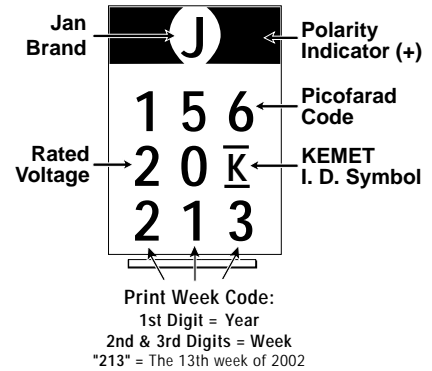

Note on Failure Rates:
Exponential failure rate levels M, P, R and S are inactive for new design per MIL-C-55365. Parts qualified to Weibull failure rate levels are substitutable for exponential failure rate levels.
Note: ESR limits are per Mil-C-55365/8

To complete Part Numbers:

- (1) Insert "M" for ±20% tolerance, "K" for ±10% tolerance or "J" for ±5% tolerance.
- (2) Insert Failure Rate Symbol: B (0.1%/1000 hours), C (0.01%/1000 hours) or D (0.001%/1000 hours).

FEATURES

- Low ESR values in EIA 535BAAC sizes
- Taped and Reeled per EIA 481-1
- Symmetrical, Compliant Terminations
- Optional Gold-plated Terminations
- Laser-marked Case
- 100% Surge Current test on C, D, E, U, V, X sizes
- Capacitance: 0.1 μ F to 1000 μ F
- Tolerance: $\pm 10\%$, $\pm 20\%$
- Voltage: 3-50 VDC
- Extended Range Values
- New Low Profile Case Sizes

CAPACITOR OUTLINE DRAWING

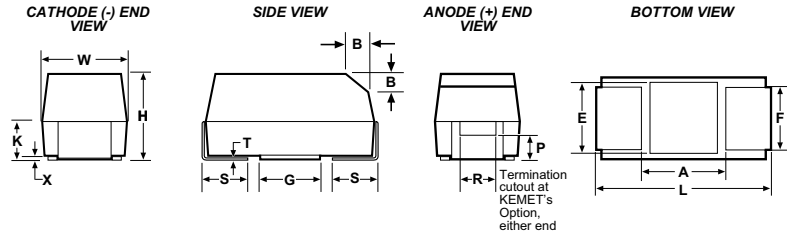

STANDARD T494 DIMENSIONS Millimeters (inches)

CASE SIZE		COMPONENT													
KEMET	EIA	L*	W*	H*	K* ± 0.20 $\pm (.008)$	F* ± 0.1 $\pm (.004)$	S* ± 0.3 $\pm (.012)$	B ± 0.15 $(\text{Ref}) \pm (.006)$	X (Ref)	P (Ref)	R (Ref)	T (Ref)	A (Min)	G (Ref)	E (Ref)
A	3216-18	3.2 \pm 0.2 (.126 \pm .008)	1.6 \pm 0.2 (.063 \pm .008)	1.6 \pm 0.2 (.063 \pm .008)	0.9 (.035)	1.2 (.047)	0.8 (.031)	0.4 (.016)	0.10 \pm 0.10 (.004 \pm .004)	0.4 (.016)	0.4 (.016)	0.13 (.005)	0.8 (.031)	1.1 (.043)	1.3 (.051)
B	3528-21	3.5 \pm 0.2 (.138 \pm .008)	2.8 \pm 0.2 (.110 \pm .008)	1.9 \pm 0.2 (.075 \pm .008)	1.1 (.043)	2.2 (.087)	0.8 (.031)	0.4 (.016)	0.10 \pm 0.10 (.004 \pm .004)	0.5 (.020)	1.0 (.039)	1.1 (.005)	1.1 (.043)	1.8 (.071)	2.2 (.087)
C	6032-28	6.0 \pm 0.3 (.236 \pm .012)	3.2 \pm 0.3 (.126 \pm .012)	2.5 \pm 0.3 (.098 \pm .012)	1.4 (.055)	2.2 (.087)	1.3 (.051)	0.5 (.020)	0.10 \pm 0.10 (.004 \pm .004)	0.9 (.035)	1.0 (.039)	0.13 (.005)	2.5 (.098)	2.8 (.110)	2.4 (.094)
D	7343-31	7.3 \pm 0.3 (.287 \pm .012)	4.3 \pm 0.3 (.169 \pm .012)	2.8 \pm 0.3 (.110 \pm .012)	1.5 (.059)	2.4 (.094)	1.3 (.051)	0.5 (.020)	0.10 \pm 0.10 (.004 \pm .004)	0.9 (.035)	1.0 (.039)	0.13 (.005)	3.8 (.150)	3.5 (.138)	3.5 (.138)
X	7343-43	7.3 \pm 0.3 (.287 \pm .012)	4.3 \pm 0.3 (.169 \pm .012)	4.0 \pm 0.3 (.157 \pm .012)	2.3 (.091)	2.4 (.094)	1.3 (.051)	0.5 (.020)	0.10 \pm 0.10 (.004 \pm .004)	1.7 (.067)	1.0 (.039)	0.13 (.005)	3.8 (.150)	3.5** (.138)	3.5** (.138)
E	7260-38	7.3 \pm 0.3 (.287 \pm .012)	6.0 \pm 0.3 (.236 \pm .012)	3.6 \pm 0.2 (.142 \pm .008)	2.3 (.091)	4.1 (.161)	1.3 (.051)	0.5 (.020)	0.10 \pm 0.10 (.004 \pm .004)	0.9 (.035)	1.0 (.039)	0.13 (.005)	3.8 (.150)	3.5 (.138)	3.5 (.138)

- Notes: 1. Metric dimensions govern.
 2. (Ref) - Dimensions provided for reference only.
 * Mil-C-55365/8 Specified Dimensions
 ** Round Glue Pad: 2.9 \pm 0.1mm (0.114" \pm 0.004") in diameter at KEMET's option

LOW PROFILE T494 DIMENSIONS Millimeters (inches)

CASE SIZE		COMPONENT										
KEMET	EIA	L	W	H Max.	K Min.	F ± 0.1	S ± 0.3	X (Ref)	T (Ref)	A (Min)	G (Ref)	E (Ref)
R	2012-12	2.0 \pm 0.2 (.079 \pm .008)	1.3 \pm 0.2 (.051 \pm .008)	1.2 (.047)	0.3 (.012)	0.9 (.035)	0.5 (.020)	0.05 (.002)	0.13 (.005)	0.8 (.031)	0.5 (.020)	0.8 (.031)
S	3216-12	3.2 \pm 0.2 (.126 \pm .008)	1.6 \pm 0.2 (.063 \pm .008)	1.2 (.047)	0.3 (.012)	1.2 (.047)	0.8 (.031)	0.05 (.002)	0.13 (.005)	0.8 (.031)	1.1 (.043)	1.3 (.051)
T	3528-12	3.5 \pm 0.2 (.138 \pm .008)	2.8 \pm 0.2 (.110 \pm .008)	1.2 (.047)	0.3 (.012)	2.2 (.087)	0.8 (.031)	0.05 (.002)	0.13 (.005)	1.1 (.043)	1.8 (.071)	2.2 (.087)
U	6032-15	6.0 \pm 0.3 (.236 \pm .012)	3.2 \pm 0.3 (.126 \pm .012)	1.5 (.059)	0.5 (.020)	2.2 (.087)	1.3 (.051)	0.05 (.002)	0.13 (.005)	2.5 (.098)	2.8 (.110)	2.4 (.094)
V	7343-20	7.3 \pm 0.3 (.287 \pm .012)	4.3 \pm 0.3 (.169 \pm .012)	2.0 (.079)	0.9 (.035)	2.4 (.094)	1.3 (.051)	0.05 (.002)	0.13 (.005)	3.8 (.150)	3.5 (.138)	3.5 (.138)

- Notes: 1. Metric dimensions govern.
 2. (Ref) - Dimensions provided for reference only.
 3. No dimensions provided for B, P or R because low profile cases do not have a bevel or a notch.

T494 ORDERING INFORMATION

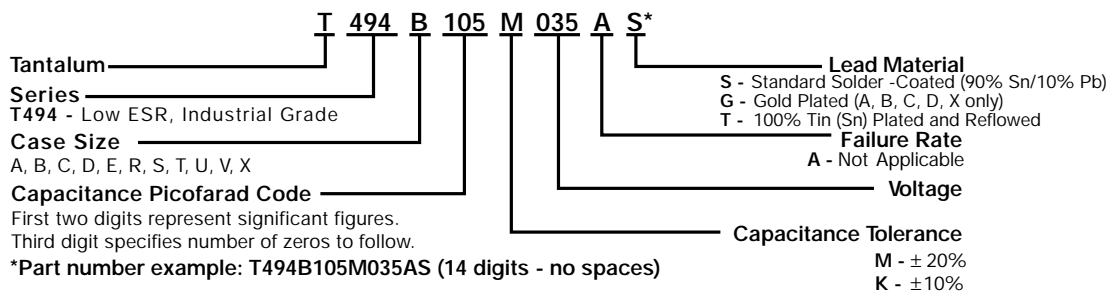

T494 RATINGS & PART NUMBER REFERENCE

Capacitance µF	Case Size	KEMET Part Number	DC Leakage µA @ 25°C Max	DF % @ +25°C 120 Hz Max	ESR W @ +25°C 100 kHz Max
3 Volt Rating at +85°C (2 Volt Rating at +125°C)					
#33.0	*A	T494A336(1)003AS	1.0	6.0	2.0
4 Volt Rating at +85°C (2.7 Volt Rating at +125°C)					
3.3	A	T494A335(1)004AS	0.5	6.0	4.0
4.7	A	T494A475(1)004AS	0.5	6.0	3.5
6.8	A	T494A685(1)004AS	0.5	6.0	3.0
6.8	S	T494S685(1)004AS	0.5	6.0	7.0
10.0	B	T494B106(1)004AS	0.5	6.0	1.2
10.0	A	T494A106(1)004AS	0.5	6.0	2.0
#10.0	*S	T494S106(1)004AS	0.5	6.0	9.0
#10.0	*R	T494R106M004AS	0.5	8.0	6.0
15.0	B	T494B156(1)004AS	0.6	6.0	1.2
15.0	A	T494A156(1)004AS	0.6	6.0	1.5
15.0	T	T494T156(1)004AS	0.6	6.0	2.0
#15.0	*S	T494S156M004AS	0.6	10.0	9.0
22.0	C	T494C226(1)004AS	0.9	6.0	0.5
22.0	B	T494B226(1)004AS	0.9	6.0	0.6
#22.0	*A	T494A226(1)004AS	0.9	6.0	1.5
#22.0	*S	T494S226M004AS	0.9	10.0	8.0
#22.0	*T	T494T226(1)004AS	0.9	6.0	2.5
33.0	C	T494C336(1)004AS	1.3	6.0	0.5
33.0	U	T494U336(1)004AS	1.3	6.0	0.6
33.0	B	T494B336(1)004AS	1.3	6.0	0.5
#33.0	*A	T494A336(1)004AS	1.3	6.0	3.0
#33.0	*T	T494T336M004AS	1.3	8.0	3.5
47.0	C	T494C476(1)004AS	1.9	6.0	0.5
47.0	U	T494U476(1)004AS	1.9	6.0	0.6
#47.0	*B	T494B476(1)004AS	1.9	6.0	0.5
#47.0	*A	T494A476M004AS	1.9	12.0	2.0
#47.0	T	T494T476M004AS	1.9	12.0	4.0
68.0	D	T494D686(1)004AS	2.7	6.0	0.20
68.0	C	T494C686(1)004AS	2.7	6.0	0.25
#68.0	*U	T494U686(1)004AS	2.7	6.0	0.60
#68.0	*B	T494B686(1)004AS	2.7	6.0	2.00
#68.0	A	T494A686(1)004AS	2.8	30.0	3.00
100.0	D	T494D107(1)004AS	4.0	8.0	0.20
#100.0	*C	T494C107(1)004AS	4.0	8.0	0.20
#100.0	*U	T494U107(1)004AS	4.0	10.0	1.00
#100.0	*B	T494B107M004AS	4.0	8.0	0.65
#100.0	*A	T494A107M004AS	4.0	30.0	3.00
150.0	D	T494D157(1)004AS	6.0	8.0	0.15
150.0	V	T494V157(1)004AS	6.0	8.0	0.20
#150.0	*C	T494C157(1)004AS	6.0	8.0	0.30
†150.0	*B	T494B157M004AS	6.0	12.0	1.00
#220.0	*V	T494V227(1)004AS	8.8	8.0	0.30
#330.0	*D	T494D337(1)004AS	13.2	8.0	0.15
#330.0	*C	T494C337(1)004AS	13.2	10.0	0.09
#330.0	*V	T494V337M004AS	13.2	12.0	0.30
#470.0	*X	T494X477(1)004AS	18.8	8.0	0.15
#470.0	*D	T494D477(1)004AS	18.8	8.0	0.15
#680.0	*X	T494X687M004AS	27.2	12.0	0.10
#680.0	D	T494D687M004AS	27.2	12.0	0.15
#1000.0	*X	T494X108(1)004AS	40.0	12.0	0.10
#1000.0	*E	T494E108M004AS	40.0	15.0	0.08
**6 Volt Rating at +85°C (4 Volt Rating at +125°C)					
2.2	A	T494A225(1)006AS	0.5	6.0	6.0
3.3	A	T494A335(1)006AS	0.5	6.0	6.0
4.7	A	T494A475(1)006AS	0.5	6.0	3.5
4.7	S	T494S475(1)006AS	0.5	6.0	8.0
6.8	B	T494B685(1)006AS	0.5	6.0	1.2
6.8	A	T494A685(1)006AS	0.5	6.0	2.0
#6.8	*S	T494S685(1)006AS	0.5	6.0	9.0
#6.8	*R	T494R685(1)006AS	0.5	8.0	10.0
10.0	B	T494B106(1)006AS	0.6	6.0	1.0
10.0	A	T494A106(1)006AS	0.6	6.0	2.0
10.0	T	T494T106(1)006AS	0.6	6.0	1.2
#10.0	*S	T494S106M006AS	0.6	10.0	9.0
#10.0	*R	T494R106M006AS	0.6	8.0	6.0
15.0	C	T494C156(1)006AS	0.9	6.0	0.6
15.0	B	T494B156(1)006AS	0.9	6.0	0.7
#15.0	*A	T494A156(1)006AS	0.9	6.0	2.0
#15.0	*T	T494T156(1)006AS	0.9	6.0	2.5
#15.0	S	T494S156M006AS	0.9	10.0	10.0
22.0	C	T494C226(1)006AS	1.4	6.0	0.5
22.0	U	T494U226(1)006AS	1.4	6.0	0.8
22.0	B	T494B226(1)006AS	1.4	6.0	0.6
#22.0	*A	T494A226(1)006AS	1.4	6.0	3.0
#22.0	*T	T494T226M006AS	1.4	8.0	3.5
33.0	C	T494C336(1)006AS	2.0	6.0	0.3
33.0	U	T494U336(1)006AS	2.0	6.0	0.6
#33.0	*B	T494B336(1)006AS	2.0	6.0	0.6
#33.0	*A	T494A336M006AS	2.0	12.0	2.0
#33.0	T	T494T336M006AS	2.0	12.0	4.0
47.0	D	T494D476(1)006AS	2.9	6.0	0.22
47.0	C	T494C476(1)006AS	2.9	6.0	0.25
#47.0	*U	T494U476(1)006AS	2.9	6.0	0.60
#47.0	*B	T494B476(1)006AS	2.9	6.0	2.00
†47.0	*A	T494A476M006AS	3.0	12.0	2.50

Capacitance µF	Case Size	KEMET Part Number	DC Leakage µA @ 25°C Max	DF % @ +25°C 120 Hz Max	ESR W @ +25°C 100 kHz Max
**6 Volt Rating at +85°C (4 Volt Rating at +125°C)					
68.0	D	T494D686(1)006AS	4.1	6.0	0.20
#68.0	*C	T494C686(1)006AS	4.1	6.0	0.20
#68.0	*U	T494U686(1)006AS	4.1	10.0	1.00
#68.0	*B	T494B686M006AS	4.1	8.0	0.65
100.0	D	T494D107(1)006AS	6.0	8.0	0.15
100.0	V	T494V107(1)006AS	6.0	8.0	0.20
#100.0	*C	T494C107(1)006AS	6.0	8.0	0.30
#100.0	U	T494U107M006AS	6.0	10.0	1.20
#100.0	*B	T494B107M006AS	6.3	15.0	8.00
150.0	D	T494D157(1)006AS	9.0	8.0	0.15
#150.0	*C	T494C157M006AS	9.0	8.0	0.30
#150.0	*V	T494V157(1)006AS	9.0	8.0	0.30
220.0	X	T494X227(1)006AS	13.2	8.0	0.15
#220.0	*D	T494D227(1)006AS	13.2	8.0	0.15
#220.0	*C	T494C227M006AS	13.2	10.0	0.30
#220.0	*V	T494V227M006AS	13.2	12.0	0.30
#330.0	*X	T494X337(1)006AS	19.8	8.0	0.15
#330.0	*D	T494D337(1)006AS	19.8	8.0	0.15
#470.0	*X	T494X477(1)006AS	28.2	10.0	0.10
#470.0	*D	T494D477M006AS	28.2	12.0	0.15
#680.0	E	T494E687M006AS	40.8	12.0	0.10
10 Volt Rating at +85°C (7 Volt Rating at +125°C)					
1.5	A	T494A155(1)010AS	0.5	6.0	6.0
2.2	A	T494A225(1)010AS	0.5	6.0	6.0
3.3	A	T494A335(1)010AS	0.5	6.0	4.0
3.3	S	T494S335(1)010AS	0.5	6.0	9.0
#3.3	*R	T494R335(1)010AS	0.3	8.0	10.0
4.7	B	T494B475(1)010AS	0.5	6.0	1.5
4.7	A	T494A475(1)010AS	0.5	6.0	3.0
#4.7	*S	T494S475(1)010AS	0.5	6.0	9.0
#4.7	*R	T494R475M010AS	0.5	8.0	8.0
6.8	B	T494B685(1)010AS	0.7	6.0	1.2
6.8	A	T494A685(1)010AS	0.7	6.0	3.0
6.8	T	T494T685(1)010AS	0.7	6.0	2.0
#6.8	*S	T494S685M010AS	0.7	10.0	9.0
10.0	C	T494C106(1)010AS	1.0	6.0	0.6
10.0	B	T494B106(1)010AS	1.0	6.0	0.8
#10.0	*A	T494A106(1)010AS	1.0	6.0	1.8
#10.0	*T	T494T106(1)010AS	1.0	6.0	3.5
#10.0	S	T494S106M010AS	1.0	10.0	12.0
15.0	C	T494C156(1)010AS	1.5	6.0	0.5
15.0	U	T494U156(1)010AS	1.5	6.0	0.8
15.0	B	T494B156(1)010AS	1.5	6.0	0.7
#15.0	*A	T494A156(1)010AS	1.5	8.0	4.0
#15.0	*T	T494T156M010AS	1.5	8.0	3.5
22.0	C	T494C226(1)010AS	2.2	6.0	0.4
22.0	U	T494U226(1)010AS	2.2	6.0	0.8
#22.0	*B	T494B226(1)010AS	2.2	6.0	0.7
#22.0	*A	T494A226M010AS	2.2	10.0	4.5
#22.0	T	T494T226M010AS	2.2	12.0	6.0
33.0	D	T494D336(1)010AS	3.3	6.0	0.25
33.0	V	T494V336(1)010AS	3.3	6.0	0.30
33.0	C	T494C336(1)010AS	3.3	6.0	0.30
#33.0	*U	T494U336(1)010AS	3.3	6.0	0.60
#33.0	*B	T494B336(1)010AS	3.3	6.0	2.00
47.0	D	T494D476(1)010AS	4.7	6.0	0.22
47.0	V	T494V476(1)010AS	4.7	6.0	0.30
#47.0	*C	T494C476(1)010AS	4.7	6.0	0.30
#47.0	*U	T494U476(1)010AS	4.7	10.0	1.20
#47.0	*B	T494B476M010AS	4.7	8.0	0.65
68.0	D	T494D686(1)010AS	6.8	6.0	0.20
#68.0	*C	T494C686(1)010AS	6.8	6.0	0.30
68.0	V	T494V686(1)010AS	6.8	6.0	0.30
#68.0	U	T494U686M010AS	6.8	10.0	1.20
#68.0	*B	T494B686M010AS	6.8	10.0	1.50
100.0	D	T494D107(1)010AS	10.0	8.0	0.15
#100.0	*C	T494C107(1)010AS	10.0	8.0	0.20
#100.0	*V	T494V107(1)010AS	10.0	8.0	0.40
150.0	X	T494X157(1)010AS	15.0	8.0	0.15
#150.0	*D	T494D157(1)010AS	15.0	8.0	0.15
#150.0	*C	T494C157(1)010AS	15.0	10.0	0.90
#150.0	V	T494V157M010AS	15.0	8.0	0.30
#220.0	*X	T494X227(1)010AS	22.0	8.0	0.15
#220.0	*D	T494D227(1)010AS	22.0	8.0	0.15
#220.0	*V	T494V227(1)010AS	22.0	12.0	0.50
#330.0	X	T494X337(1)010AS	33.0	10.0	0.10
#330.0	*D	T494D337M010AS	33.0	10.0	0.15
#470.0	E	T494E477M010AS	47.0	12.0	0.10

*Extended Values

**6 Volt product equivalent to 6.3 volt product.

(1) To complete KEMET Part Number

T494 RATINGS & PART NUMBER REFERENCE

Capacitance µF	Case Size	KEMET Part Number	DC Leakage µA @ 25°C Max	DF % @ +25°C 120 Hz Max	ESR W @ +25°C 100 kHz Max
16 Volt Rating at +85°C (10 Volt Rating at +125°C)					
1.0	A	T494A105(1)016AS	0.5	4.0	6.0
1.5	A	T494A155(1)016AS	0.5	6.0	6.0
2.2	A	T494A225(1)016AS	0.5	6.0	4.0
2.2	*S	T494S225(1)016AS	0.5	6.0	10.0
#2.2	*R	T494R225M016AS	0.5	8.0	20.0
3.3	B	T494B335(1)016AS	0.5	6.0	2.0
3.3	A	T494A335(1)016AS	0.5	6.0	4.0
4.7	B	T494B475(1)016AS	0.8	6.0	1.5
4.7	A	T494A475(1)016AS	0.8	6.0	3.0
4.7	T	T494T475(1)016AS	0.8	6.0	3.0
6.8	C	T494C685(1)016AS	1.1	6.0	0.8
6.8	B	T494B685(1)016AS	1.1	6.0	1.2
#6.8	*A	T494A685(1)016AS	1.1	6.0	3.0
10.0	C	T494C106(1)016AS	1.6	6.0	0.6
10.0	U	T494U106(1)016AS	1.6	6.0	1.0
10.0	B	T494B106(1)016AS	1.6	6.0	0.8
#10.0	*A	T494A106(1)016AS	1.6	10.0	3.0
#10.0	*T	T494T106M016AS	1.6	8.0	6.0
15.0	C	T494C156(1)016AS	2.4	6.0	0.4
15.0	U	T494U156(1)016AS	2.4	6.0	0.8
#15.0	*B	T494B156(1)016AS	2.4	6.0	0.8
22.0	D	T494D226(1)016AS	3.6	6.0	0.25
22.0	C	T494C226(1)016AS	3.6	6.0	0.35
#22.0	*U	T494U226(1)016AS	3.6	10.0	1.80
#22.0	*B	T494B226(1)016AS	3.6	6.0	1.00
33.0	D	T494D336(1)016AS	5.3	6.0	0.25
#33.0	*C	T494C336(1)016AS	5.3	6.0	0.30
#33.0	*U	T494U336(1)016AS	5.3	12	2.20
47.0	D	T494D476(1)016AS	7.5	6.0	0.2
47.0	V	T494V476(1)016AS	7.5	6.0	0.3
#47.0	*C	T494C476(1)016AS	7.5	6.0	0.5
68.0	*D	T494D686(1)016AS	10.9	6.0	0.15
#68.0	*V	T494V686(1)016AS	10.9	6.0	0.5
100.0	X	T494X107(1)016AS	16.0	8.0	0.15
#100.0	*D	T494D107(1)016AS	16.0	8.0	0.15
#100.0	*V	T494V107(1)016AS	16.0	12.0	0.5
#150.0	*X	T494X157(1)016AS	24.0	8.0	0.15
#150.0	*D	T494D157(1)016AS	24.0	12.0	0.4
20 Volt Rating at +85°C (13 Volt Rating at +125°C)					
0.7	A	T494A684(1)020AS	0.5	4.0	8.0
1.0	A	T494A105(1)020AS	0.5	4.0	5.5
1.0	S	T494S105(1)020AS	0.5	6.0	10.0
1.0	R	T494R105M020AS	0.2	6.0	15.0
1.5	A	T494A155(1)020AS	0.5	6.0	4.5
1.5	S	T494S155(1)020AS	0.5	6.0	9.0
2.2	B	T494B225(1)020AS	0.5	6.0	1.5
2.2	A	T494A225(1)020AS	0.5	6.0	4.0
3.3	B	T494B335(1)020AS	0.7	6.0	1.3
#3.3	*A	T494A335(1)020AS	0.7	6.0	4.0
3.3	*T	T494T335(1)020AS	0.7	6.0	4.0
4.7	C	T494C475(1)020AS	1.0	6.0	0.6
4.7	B	T494B475(1)020AS	1.0	6.0	1.0
#4.7	*A	T494A475M020AS	1.0	8.0	3.0
6.8	C	T494C685(1)020AS	1.4	6.0	0.6
6.8	U	T494U685(1)020AS	1.4	6.0	1.4
#6.8	*B	T494B685(1)020AS	1.4	6.0	1.0
10.0	C	T494C106(1)020AS	2.0	6.0	0.5
10.0	U	T494U106(1)020AS	2.0	6.0	0.8
#10.0	*B	T494B106(1)020AS	2.0	6.0	1.0
15.0	D	T494D156(1)020AS	3.0	6.0	0.35
15.0	*C	T494C156(1)020AS	3.0	6.0	0.40
22.0	D	T494D226(1)020AS	4.4	6.0	0.3
22.0	V	T494V226(1)020AS	4.4	6.0	0.4
#22.0	*C	T494C226(1)020AS	4.4	6.0	0.4
33.0	D	T494D336(1)020AS	6.6	6.0	0.25
#33.0	*C	T494C336M020AS	6.6	6.0	0.40
†33.0	V	T494V336M020AS	6.6	8.0	0.40
47.0	*D	T494D476(1)020AS	9.4	6.0	0.2
68.0	X	T494X686(1)020AS	13.6	6.0	0.2
#68.0	*D	T494D686(1)020AS	13.6	8.0	0.2
#100.0	*X	T494X107(1)020AS	20.0	8.0	0.15

Capacitance µF	Case Size	KEMET Part Number	DC Leakage µA @ 25°C Max	DF % @ +25°C 120 Hz Max	ESR W @ +25°C 100 kHz Max
25 Volt Rating at +85°C (17 Volt Rating at +125°C)					
0.3	A	T494A334(1)025AS	0.5	4.0	10.0
0.5	A	T494A474(1)025AS	0.5	4.0	9.0
0.7	A	T494A684(1)025AS	0.5	4.0	6.0
1.0	B	T494B105(1)025AS	0.5	4.0	2.0
1.0	*A	T494A105(1)025AS	0.5	4.0	4.0
1.5	B	T494B155(1)025AS	0.5	6.0	1.5
1.5	*A	T494A155(1)025AS	0.5	6.0	5.0
2.2	C	T494C225(1)025AS	0.6	6.0	2.2
2.2	B	T494B225(1)025AS	0.6	6.0	1.2
3.3	C	T494C335(1)025AS	0.9	6.0	1.2
3.3	*B	T494B335(1)025AS	0.9	6.0	2.0
4.7	C	T494C475(1)025AS	1.2	6.0	0.6
#4.7	*B	T494B475M025AS	1.2	6.0	1.0
6.8	C	T494C685(1)025AS	1.7	6.0	0.6
10.0	D	T494D106(1)025AS	2.5	6.0	0.4
10.0	*C	T494C106(1)025AS	2.5	6.0	0.6
15.0	D	T494D156(1)025AS	3.8	6.0	0.35
#15.0	*C	T494C156(1)025AS	3.8	6.0	0.90
22.0	D	T494D226(1)025AS	5.5	6.0	0.3
22.0	*V	T494V226(1)025AS	5.5	6.0	0.5
33.0	X	T494X336(1)025AS	8.3	6.0	0.3
#33.0	*D	T494D336(1)025AS	8.3	6.0	0.4
#47.0	*X	T494X476(1)025AS	11.8	6.0	0.3
†47.0	*D	T494D476M025AS	11.8	10.0	0.2
†68.0	*X	T494X686M025AS	17.0	8.0	0.3
35 Volt Rating at +85°C (23 Volt Rating at +125°C)					
0.10	A	T494A104(1)035AS	0.5	4.0	10.0
0.15	A	T494A154(1)035AS	0.5	4.0	6.0
0.22	A	T494A224(1)035AS	0.5	4.0	6.0
0.33	A	T494A334(1)035AS	0.5	4.0	6.0
0.47	B	T494B474(1)035AS	0.5	4.0	2.5
0.47	A	T494A474(1)035AS	0.5	4.0	4.0
0.68	B	T494B684(1)035AS	0.5	4.0	2.5
0.68	*A	T494A684(1)035AS	0.5	4.0	6.0
1.0	B	T494B105(1)035AS	0.5	4.0	2.0
1.0	*A	T494A105(1)035AS	0.5	4.0	6.0
1.5	C	T494C155(1)035AS	0.5	6.0	2.5
1.5	B	T494B155(1)035AS	0.5	6.0	3.0
2.2	C	T494C225(1)035AS	0.8	6.0	1.5
2.2	*B	T494B225(1)035AS	0.8	6.0	2.5
3.3	C	T494C335(1)035AS	1.2	6.0	0.8
#3.3	*B	T494B335M035AS	1.2	6.0	1.3
4.7	D	T494D475(1)035AS	1.7	6.0	0.7
4.7	C	T494C475(1)035AS	1.7	6.0	0.7
6.8	D	T494D685(1)035AS	2.4	6.0	0.5
6.8	*C	T494C685(1)035AS	2.4	6.0	0.9
10.0	D	T494D106(1)035AS	3.5	6.0	0.4
#10.0	*C	T494C106M035AS	3.5	6.0	1.2
#10.0	*V	T494V106(1)035AS	3.5	6.0	0.8
15.0	X	T494X156(1)035AS	5.3	6.0	0.30
15.0	*D	T494D156(1)035AS	5.3	6.0	0.35
#22.0	X	T494X226(1)035AS	7.7	6.0	0.3
#22.0	*D	T494D226(1)035AS	7.7	6.0	0.4
#33.0	*X	T494X336(1)035AS	11.6	6.0	0.3
#47.0	*X	T494X476(1)035AS	16.5	8.0	0.5
50 Volt Rating at +85°C (33 Volt Rating at +125°C)					
0.10	A	T494A104(1)050AS	0.5	4.0	10.0
0.15	B	T494B154(1)050AS	0.5	4.0	10.0
0.15	*A	T494A154(1)050AS	0.5	4.0	10.0
0.22	B	T494B224(1)050AS	0.5	4.0	10.0
0.33	B	T494B334(1)050AS	0.5	4.0	2.5
0.47	C	T494C474(1)050AS	0.5	4.0	1.8
0.47	*B	T494B474(1)050AS	0.5	4.0	2.0
0.68	C	T494C684(1)050AS	0.5	4.0	1.6
0.68	*B	T494B684(1)050AS	0.5	4.0	3.0
1.0	C	T494C105(1)050AS	0.5	4.0	1.6
#1.0	*V	T494V105M050AS	0.5	4.0	4.0
1.5	D	T494D155(1)050AS	0.8	6.0	1.0
1.5	*C	T494C155(1)050AS	0.8	6.0	1.5
2.2	D	T494D225(1)050AS	1.1	6.0	0.8
2.2	*C	T494C225(1)050AS	1.1	6.0	1.5
3.3	D	T494D335(1)050AS	1.7	6.0	0.8
4.7	D	T494D475(1)050AS	2.4	6.0	0.6
6.8	X	T494X685(1)050AS	3.5	6.0	0.5
#6.8	*D	T494D685M050AS	3.4	6.0	0.7
#10.0	X	T494X106M050AS	5.0	6.0	0.4
#15.0	*X	T494X156(1)050AS	7.5	6.0	0.4

*Extended Values

**6 Volt product equivalent to 6.3 volt product.

(1) To complete KEMET Part Number, insert M for ±20% tolerance or K for ±10% tolerance.

Higher voltage ratings, lower ESR, and tighter capacitance tolerance product may be substituted within the same size at KEMET's option. Voltage substitutions will be marked with the higher voltage rating.

#Maximum Capacitance Change @ 125°C=+15%. †Maximum Capacitance Change @ 125°C=+20%.

New values are in red.

CAPACITOR MARKINGS T494 Series — All Case Sizes

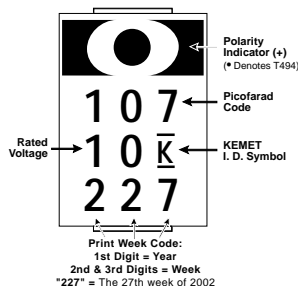

CONSTRUCTION

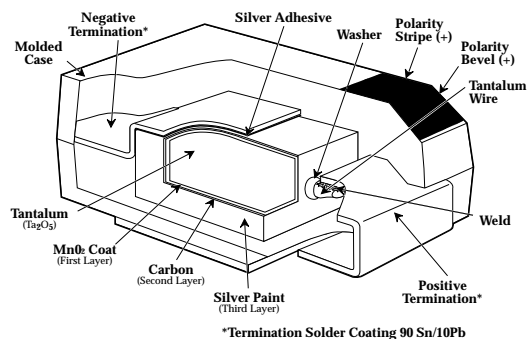

FEATURES

- Designed for very low ESR
- High ripple current capability
- High surge current capability
- 100% accelerated steady-state aging
- 100% Surge Current test
- Meets or Exceeds EIA Standard 535BAAC
- Available tested per DSCC Dwg. 95158
- New Extended Values for Low ESR
- Low Equivalent Series Inductance (<2.5nH ESL)
- Precision-molded, laser-marked case
- Symmetrical, compliant terminations
- Taped and reeled per EIA 481-1

OUTLINE DRAWING

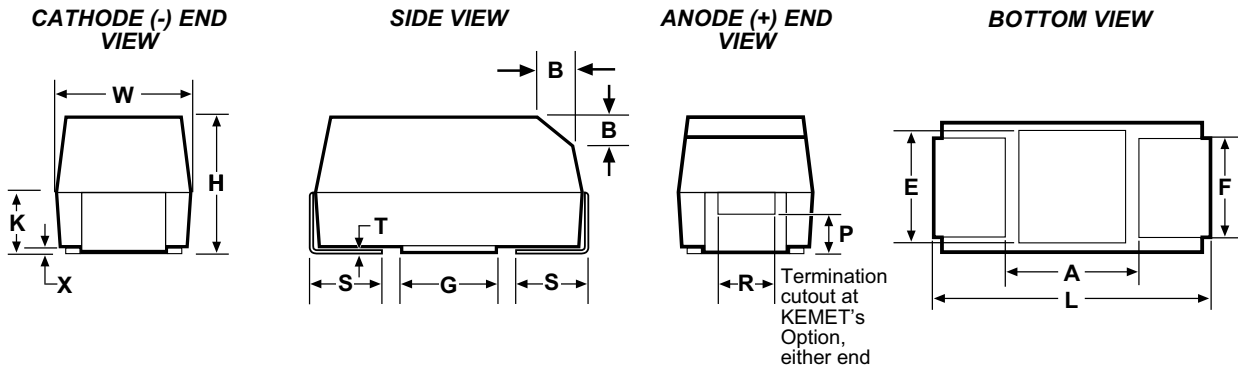

STANDARD T495 DIMENSIONS

Millimeters (Inches)

CASE SIZE		COMPONENT													
KEMA	EIA	L	W	H	K ± 0.20 $\pm (.008)$	F ± 0.1 $\pm (.004)$	S ± 0.3 $\pm (.012)$	B ± 0.15 $(\text{Ref}) \pm (.006)$	X (Ref)	P (Ref)	R (Ref)	T (Ref)	A (Min)	G (Ref)	E (Ref)
B	3528-21	3.5 ± 0.2 (.138 $\pm .008$)	2.8 ± 0.2 (.110 $\pm .008$)	1.9 ± 0.2 (.075 $\pm .008$)	1.1 (.043)	2.2 (.087)	0.8 (.031)	0.4 (.016)	0.10 ± 0.10 (.004 $\pm .004$)	0.5 (.020)	1.0 (.039)	0.13 (.005)	1.1 (.043)	1.8 (.071)	2.2 (.087)
C	6032-28	6.0 ± 0.3 (.236 $\pm .012$)	3.2 ± 0.3 (.126 $\pm .012$)	2.5 ± 0.3 (.098 $\pm .012$)	1.4 (.055)	2.2 (.087)	1.3 (.051)	0.5 (.020)	0.10 ± 0.10 (.004 $\pm .004$)	0.9 (.035)	1.0 (.039)	0.13 (.005)	2.5 (.098)	2.8 (.110)	2.4 (.094)
D	7343-31	7.3 ± 0.3 (.287 $\pm .012$)	4.3 ± 0.3 (.169 $\pm .012$)	2.8 ± 0.3 (.110 $\pm .012$)	1.5 (.059)	2.4 (.094)	1.3 (.051)	0.5 (.020)	0.10 ± 0.10 (.004 $\pm .004$)	0.9 (.035)	1.0 (.039)	0.13 (.005)	3.8 (.150)	3.5 (.138)	3.5 (.138)
X	7343-43	7.3 ± 0.3 (.287 $\pm .012$)	4.3 ± 0.3 (.169 $\pm .012$)	4.0 ± 0.3 (.157 $\pm .012$)	2.3 (.091)	2.4 (.094)	1.3 (.051)	0.5 (.020)	0.10 ± 0.10 (.004 $\pm .004$)	1.7 (.067)	1.0 (.039)	0.13 (.005)	3.8 (.150)	3.5* (.138)	3.5* (.138)

- Notes: 1. Metric dimensions govern.
 2. (Ref) - Dimensions provided for reference only.
 * Round Glue Pad; 2.9 ± 0.1 mm (0.114" ± 0.004 ") in diameter at KEMET's option.

LOW PROFILE T495 DIMENSIONS

Millimeters (Inches)

CASE SIZE		COMPONENT										
KEMET	EIA	L	W	H Max.	K Min.	F ± 0.1	S ± 0.3	X (Ref)	T (Ref)	A (Min)	G (Ref)	E (Ref)
T	3528-12	3.5 ± 0.2 (.138 $\pm .008$)	2.8 ± 0.2 (.110 $\pm .008$)	1.2 (.047)	0.3 (.012)	2.2 (.087)	0.8 (.031)	0.05 (.002)	0.13 (.005)	1.1 (.043)	1.8 (.071)	2.2 (.087)
V	7343-20	7.3 ± 0.3 (.287 $\pm .012$)	4.3 ± 0.3 (.169 $\pm .012$)	2.0 (0.079)	0.9 (.035)	2.4 (.094)	1.3 (.051)	0.05 (.002)	0.13 (.005)	3.8 (.150)	3.5 (.138)	3.5 (.138)

- Notes: 1. Metric dimensions govern.
 2. (Ref) - Dimensions provided for reference only.
 3. No dimensions provided for B, P or R because low profile cases do not have a bevel or a notch.

SOLID TANTALUM CHIP CAPACITORS

T495 SERIES—Low ESR, Surge Robust



T495 RATINGS & PART NUMBER REFERENCE

Capacitance μ F	Case Size	KEMET Part Number	DSCC Dwg. No. 95158 Part Number	DC Leakage μ A @ 25°C Max	DF% @ 25°C 120 Hz Max	ESR MW @ 25°C 100 kHz Max	Ripple Current mA rms at 25°C, 100 kHz Max		
							25°C	85°C	125°C
4 Volt Rating @ +85°C (2.7 Volt Rating at +125°C)									
150.0	B	T495B157M004AS		6.0	12.0	90	307	277	123
330.0	*C	T495C337(1)004AS		13.2	12.0	700	396	357	159
1000.0	*X	T495X108(1)004AS		40.0	12.0	70	1535	1381	614
6/6.3 Volt Rating @ +85°C (4 Volt Rating at +125°C)									
68.0	D	T495D686(1)006AS		3.3	4.0	175	926	833	370
68.0	D	T495D686(1)006AS4095	95158-01(1)(2)	3.3	4.0	175	926	833	370
100.0	*C	T495C107(1)006AS		6.0	8.0	150	856	770	342
100.0	*V	T495V107(1)006AS		6.0	8.0	150	913	822	365
100.0	*B	T495B107M006AS		6.3	15.0	700	348	313	139
150.0	C	T495C157M006AS		9.0	8.0	200	742	668	297
150.0	X	T495X157(1)006AS		7.2	6.0	100	1285	1156	514
150.0	*X	T495X157(1)006AS4095	95158-02(1)(2)	7.2	6.0	125	1150	1040	460
220.0	*C	T495C227(1)006AS		13.9	10.0	225	700	600	300
220.0	*D	T495D227(1)006AS		13.2	8.0	100	1225	1102	490
220.0	*D	T495D227(1)006AS4095	95158-25(1)(2)	13.2	8.0	100	1225	1102	490
220.0	*X	T495X227(1)006AS		13.2	8.0	100	1285	1156	514
220.0	*X	T495X227(1)006AS4095	95158-03(1)(2)	13.2	8.0	100	1285	1156	514
330.0	*D	T495D337(1)006AS		20.8	8.0	100	1225	1102	490
330.0	*X	T495X337(1)006AS		19.8	8.0	100	1285	1156	514
330.0	*X	T495X337(1)006AS4823		19.8	8.0	65	1593	1434	637
470.0	*D	T495D477(1)006AS		29.6	12.0	125	1095	986	438
470.0	*X	T495X477(1)006AS		28.2	10.0	65	1593	1434	637
470.0	*X	T495X477(1)006AS4823		28.2	10.0	50	1816	1634	726
10 Volt Rating @ +85°C (7 Volt Rating at +125°C)									
22.0	C	T495C226(1)010AS		2.2	6.0	345	565	508	226
47.0	D	T495D476(1)010AS		3.8	4.0	200	866	780	346
47.0	D	T495D476(1)010AS4095	95158-04(1)(2)	3.8	4.0	200	866	780	346
68.0	*B	T495B686M010AS		6.8	10.0	900	307	276	123
68.0	*C	T495C686(1)010AS		6.8	6.0	225	700	630	280
68.0	*V	T495V686(1)010AS		6.8	6.0	140	945	850	378
68.0	D	T495D686(1)010AS		6.8	6.0	150	1000	900	400
68.0	X	T495X686(1)010AS		5.4	4.0	150	1049	944	420
68.0	X	T495X686(1)010AS4095	95158-05(1)(2)	5.4	4.0	150	1049	944	420
100.0	*V	T495V107(1)010AS		10.0	8.0	150	913	822	365
100.0	*D	T495D107(1)010AS4095	95158-06(1)(2)	10.0	8.0	100	1220	1100	490
100.0	*D	T495D107(1)010AS4823		10.0	8.0	80	1369	1232	548
100.0	X	T495X107(1)010AS		8.0	6.0	100	1285	1156	514
100.0	X	T495X107(1)010AS4095	95158-07(1)(2)	8.0	6.0	100	1285	1156	514
150.0	V	T495V157M010AS		15.0	8.0	150	913	822	365
150.0	*D	T495D157(1)010AS		15.0	8.0	100	1225	1102	490
150.0	*D	T495D157(1)010AS4095	95158-26(1)(2)	15.0	8.0	100	1225	1102	490
150.0	*X	T495X157(1)010AS		15.0	8.0	100	1285	1156	514
150.0	*X	T495X157(1)010AS4095	95158-08(1)(2)	15.0	8.0	100	1285	1156	514
150.0	*X	T495X157(1)010AS4823		15.0	8.0	85	1393	1254	557
220.0	*V	T495V227(1)010AS		22.0	12.0	150	913	822	365
220.0	*D	T495D227(1)010AS		22.0	8.0	125	1095	986	438
220.0	*X	T495X227(1)010AS		22.0	8.0	100	1285	1156	514
220.0	*X	T495X227(1)010AS4095	95158-28(1)(2)	15.0	8.0	100	1285	1156	514
220.0	*X	T495X227(1)010AS4823		22.0	8.0	70	1535	1382	614
330.0	*D	T495D337(1)010AS		33.0	10.0	125	1095	986	438
330.0	*X	T495X337(1)010AS		33.0	10.0	60	1658	1492	663
16 Volt Rating @ +85°C (10 Volt Rating at +125°C)									
10.0	*T	T495T106M016AS		1.6	8.0	4000	132	119	53
33.0	*C	T495C336(1)016AS		5.3	6.0	275	632	569	253
33.0	*D	T495D336(1)016AS4095	95158-09(1)(2)	4.2	4.0	250	770	700	310
47.0	*D	T495D476(1)016AS		7.5	6.0	150	1000	900	400
47.0	*D	T495D476(1)016AS4095	95158-10(1)(2)	7.5	6.0	200	870	780	345
68.0	*D	T495D686(1)016AS		10.9	6.0	150	1000	900	400
100.0	*D	T495D107(1)016AS		16.0	8.0	125	1095	986	438
100.0	*X	T495X107(1)016AS		16.0	8.0	100	1285	1156	514
100.0	*X	T495X107(1)016AS4095	95158-11(1)(2)	16.0	8.0	125	1285	1156	514
100.0	*X	T495X107(1)016AS4823		16.0	8.0	80	1436	1293	574
150.0	*x	T495X157(1)016AS		24.0	8.0	100	1285	1156	514

- (1) To complete KEMET Part Number, insert M for $\pm 20\%$ or K for $\pm 10\%$ tolerance.
 (2) To complete KEMET Part Number, insert "B" for gold plated or "H" for solder plated termination finish.

Higher voltage ratings and tighter capacitance tolerance product may be substituted within the same size at KEMET's option. Voltage substitutions will be marked with the higher voltage rating.
 *Extended Values **6 Volt product equivalent to 6.3 volt product.

T495 Series – ORDERING INFORMATION

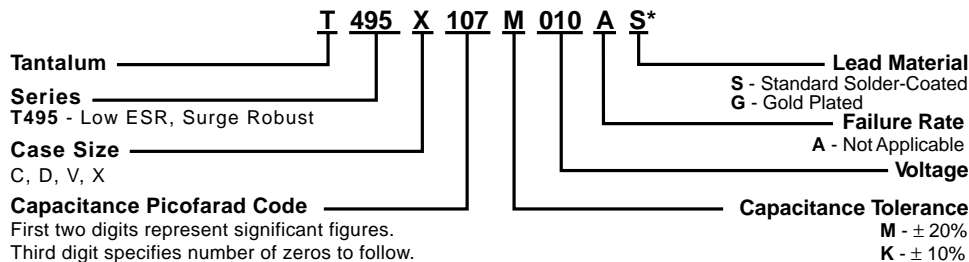

T495 RATINGS & PART NUMBER REFERENCE

Capacitance μ F	Case Size	KEMET Part Number	DSCC Dwg. No. 95158 Part Number	DC Leakage μ A @ 25°C Max	DF% @ 25°C 120 Hz Max	ESR MW @ 25°C 100 kHz Max	Ripple Current mA rms at 25°C, 100 kHz Max		
20 Volt Rating @ +85°C (13 Volt Rating at +125°C)									
15.0	D	T495D156(1)020AS		2.4	4.0	275	738	665	295
15.0	D	T495D156(1)020AS4095	95158-12(1)(2)	2.4	4.0	275	738	665	295
22.0	D	T495D226(1)020AS		3.5	4.0	225	816	735	326
22.0	D	T495D226(1)020AS4095	95158-13(1)(2)	3.5	4.0	275	816	735	326
33.0	*D	T495D336(1)020AS		6.6	6.0	200	866	780	346
47.0	*D	T495D476(1)020AS		9.4	6.0	175	926	833	370
47.0	X	T495X476(1)020AS		7.5	4.0	150	1049	944	420
47.0	X	T495X476(1)020AS4095	95158-14(1)(2)	7.5	4.0	150	1049	944	420
68.0	*D	T495D686(1)020AS		13.6	8.0	150	1000	900	400
68.0	*X	T495X686(1)020AS		13.6	6.0	150	1049	944	420
68.0	*X	T495X686(1)020AS4095	95158-15(1)(2)	13.6	6.0	150	1049	944	420
25 Volt Rating @ +85°C (17 Volt Rating at +125°C)									
6.8	C	T495C685(1)025AS		1.7	6.0	500	469	422	188
10.0	*C	T495C106(1)025AS		2.5	6.0	450	494	445	198
15.0	D	T495D156(1)025AS		3.8	6.0	275	738	665	295
15.0	D	T495D156(1)025AS4095	95158-16(1)(2)	3.8	6.0	275	738	665	295
15.0	X	T495X156(1)025AS		3.0	4.0	200	908	817	363
15.0	X	T495X156(1)025AS4095	95158-17(1)(2)	3.0	4.0	200	908	817	363
22.0	*D	T495D226(1)025AS		5.5	6.0	200	866	780	346
22.0	X	T495X226(1)025AS		4.4	4.0	225	856	771	343
22.0	X	T495X226(1)025AS4095	95158-18(1)(2)	4.4	4.0	225	856	771	343
33.0	*D	T495D336(1)025AS		8.3	6.0	300	707	636	283
33.0	X	T495X336(1)025AS		6.6	4.0	175	971	874	388
33.0	X	T495X336(1)025AS4095	95158-19(1)(2)	6.6	4.0	175	971	874	388
47.0	X	T495X476M025AS		11.8	6.0	200	908	817	363
68.0	*X	T495X686(1)025AS		17.0	8.0	200	908	817	363
35 Volt Rating @ +85°C (23 Volt Rating at +125°C)									
4.7	*C	T495C475(1)035AS		1.7	6.0	600	428	385	171
6.8	*D	T495D685(1)035AS		2.4	6.0	400	612	551	245
6.8	X	T495X685(1)035AS		1.9	4.0	300	742	667	297
6.8	X	T495X685(1)035AS4095	95158-20(1)(2)	1.9	4.0	300	742	667	297
10.0	D	T495D106(1)035AS		3.5	6.0	300	707	636	283
10.0	D	T495D106(1)035AS4095	95158-27(1)(2)	3.5	4.0	300	707	636	283
10.0	X	T495X106(1)035AS		2.8	4.0	250	812	731	325
10.0	X	T495X106(1)035AS4095	95158-21(1)(2)	2.8	4.0	250	812	731	325
15.0	*D	T495D156(1)035AS		5.3	6.0	300	707	636	283
15.0	*X	T495X156(1)035AS		5.3	6.0	225	856	771	343
15.0	*X	T495X156(1)035AS4095	95158-22(1)(2)	5.3	6.0	225	856	771	343
22.0	*D	T495D226(1)035AS		7.7	6.0	300	707	636	283
22.0	*X	T495X226(1)035AS		7.7	6.0	275	775	697	410
22.0	*X	T495X226(1)035AS4095	95158-23(1)(2)	7.7	6.0	300	742	667	297
33.0	*X	T495X336(1)035AS		11.6	6.0	250	812	731	325
47.0	*X	T495X476(1)035AS		16.5	8.0	300	742	667	297
50 Volt Rating @ +85°C (33 Volt Rating at +125°C)									
4.7	X	T495X475(1)050AS		1.9	4.0	300	742	667	297
4.7	X	T495X475(1)050AS4095	95158-24(1)(2)	1.9	4.0	300	742	667	297
6.8	*D	T495D685(1)050AS		3.4	8.0	300	700	600	300
15.0	*X	T495X156(1)050AS		7.5	8.0	300	742	667	297

- (1) To complete KEMET Part Number, insert M for $\pm 20\%$ or K for $\pm 10\%$ tolerance.
- (2) To complete KEMET Part Number, insert "B" for gold plated or "H" for solder plated termination finish.

Higher voltage ratings and tighter capacitance tolerance product may be substituted within the same size at KEMET's option. Voltage substitutions will be marked with the higher voltage rating.

*Extended Values **6 Volt product equivalent to 6.3 volt product.

CONSTRUCTION

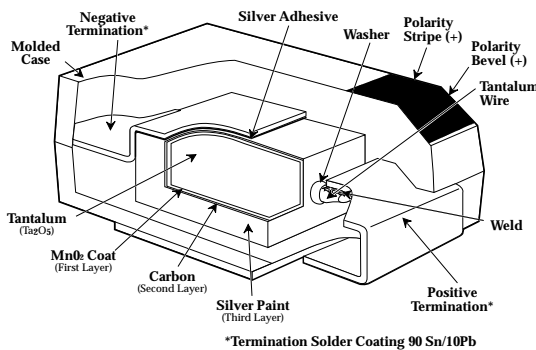

CAPACITOR MARKINGS

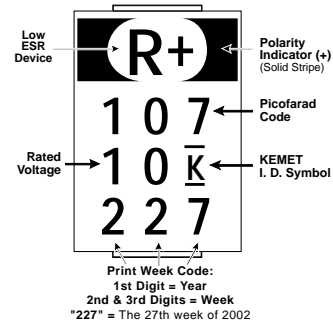

T495 TANTALUM CHIP CAPACITANCE VALUES

Case Size and Max. ESR (mΩ) by Capacitance & Voltage

Standard Capacitance Values

Capacitance		Rated Voltage @ +85°C						
μF	Code	6	10	16	20	25	35	50
4.7	475							X,300
6.8	685					C,500	X,300	
10.0	106						D,300 X,250	
15.0	156				D,275	D,275 X,200		
22.0	226		C,345		D,225	X,225		
33.0	336			D,225		X,175		
47.0	476		D,200		X,150			
68.0	686	D,175	D,150 X,150					
100.0	107		X,100					
150.0	157	X,100						
220.0	227							
330.0	337							

Extended Capacitance Values

Capacitance		Rated Voltage @ +85°C							
μF	Code	4	6	10	16	20	25	35	50
4.7	475							C,600	
6.8	685							D,400	D,300
10.0	106				T,4000		C,450		
15.0	156							D,300 X,225	X,300
22.0	226						D,200	D,300 X,275	
33.0	336				C,275	D,200	D,300	X,250	
47.0	476				D,150	D,175	X,200	X,300	
68.0	686			B, 900 C, 225 V, 140	D,150	X,150	X,200		
100.0	107		B, 700 V, 150 C, 150	V, 150 D, 100 X, 80*	D, 125 X, 100 X, 80*				
150.0	157	B,90	C,200	D, 100 X, 100 X, 85* V, 150	X,100				
220.0	227		C, 225 D, 100 X, 100	X,100 X,70*					
330.0	337	C,700	D, 100 X, 100 X, 65*	X,60 D,125					
470.0	477		X, 65 X, 50* D, 125						
1000.0	108	X,70							

Note that standard values are preferred, especially where high surge currents are possible. Extended values are available to increase capacitance and reduce ESR. Note that standard CV values demonstrate inherently lower failure rates than extended CV values, especially in low impedance applications.

* Super Low ESR limits available with part number suffix 4823.

FEATURES

- Built-in fuse protects against damaging short circuit failure mode
- Precision-molded, laser-marked case
- Symmetrical, compliant terminations
- Taped and reeled per EIA 481-1
- Case geometry and footprints equivalent to Industrial Grade T491 Series. (Case sizes B, C, D and X only)
- 100% Surge Current test on C, D, X sizes
- Patented fuse assembly
- Fuse actuation, 25°C: within 1 second at fault currents of 4 amps and higher.
- Continuous current capability: 0.75 amps
- Post-actuation resistance, 25°C: 10 megohms minimum
- Test tabs on the sides of the case bypass the capacitor element to allow direct testing of the fuse assembly.

OUTLINE DRAWINGS

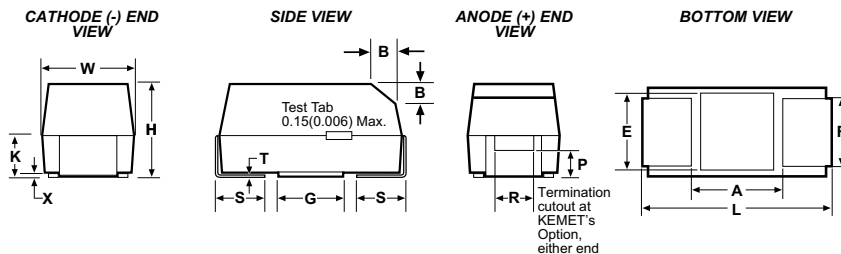

DIMENSIONS — Millimeters (Inches)

CASE SIZE		COMPONENT													
KEMET	EIA	L	W	H	K ± 0.20 ± (.008)	F ± 0.1 ± (.004)	S ± 0.3 ± (.012)	B ± 0.15 (Ref) ± (.006)	X (Ref)	P (Ref)	R (Ref)	T (Ref)	A (Min)	G (Ref)	E (Ref)
B	3528-21	3.5 ± 0.2 (.138 ± .008)	2.8 ± 0.2 (.110 ± .008)	1.9 ± 0.2 (.075 ± .008)	1.1 (.043)	2.2 (.087)	0.8 (.031)	0.4 (.016)	0.10 ± 0.10 (.004 ± .004)	0.5 (.020)	1.0 (.039)	0.13 (.005)	1.1 (.043)	1.8 (.071)	2.2 (.087)
C	6032-28	6.0 ± 0.3 (.236 ± .012)	3.2 ± 0.3 (.126 ± .012)	2.5 ± 0.3 (.098 ± .012)	1.4 (.055)	2.2 (.087)	1.3 (.051)	0.5 (.020)	0.10 ± 0.10 (.004 ± .004)	0.9 (.035)	1.0 (.039)	0.13 (.005)	2.5 (.098)	2.8 (.110)	2.4 (.094)
D	7343-31	7.3 ± 0.3 (.287 ± .012)	4.3 ± 0.3 (.169 ± .012)	2.8 ± 0.3 (.110 ± .012)	1.5 (.059)	2.4 (.094)	1.3 (.051)	0.5 (.020)	0.10 ± 0.10 (.004 ± .004)	0.9 (.035)	1.0 (.039)	0.13 (.005)	3.8 (.150)	3.5 (.138)	3.5 (.138)
X	7343-43	7.3 ± 0.3 (.287 ± .012)	4.3 ± 0.3 (.169 ± .012)	4.0 ± 0.3 (.157 ± .012)	2.3 (.091)	2.4 (.094)	1.3 (.051)	0.5 (.020)	0.10 ± 0.10 (.004 ± .004)	1.7 (.067)	1.0 (.039)	0.13 (.005)	3.8 (.150)	3.5* (.138)	3.5* (.138)

Notes: 1. Metric dimensions govern.
 2. (Ref) - Dimensions provided for reference only.
 * Round glue pad: 2.9 ± 0.1mm (.114" ± .004") in diameter at KEMET's option.

T496 Series – ORDERING INFORMATION

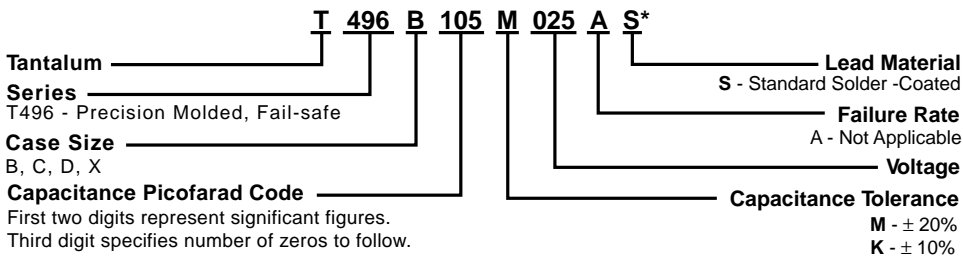

* Part Number Example: T496B105M025AS (14 digits - no spaces)

TYPICAL FUSE ACTUATION PROFILE

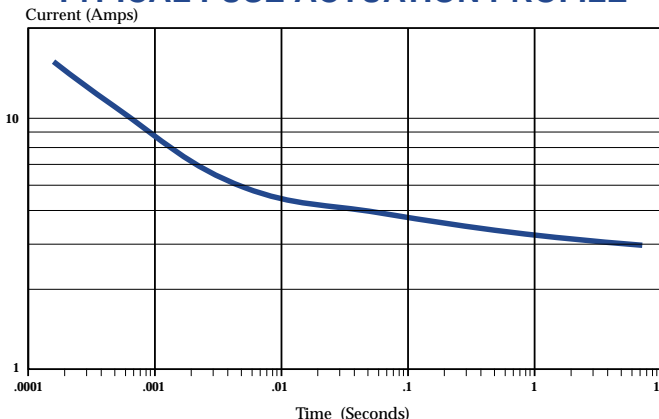

T496 RATINGS & PART NUMBER REFERENCE

Capacitance μF	Case Size	KEMET Part Number	DCL μA @ +25°C Max.	DF % @ +25°C 120 Hz. Max.	ESR Ω @ +25°C 100 kHz Max.
4 Volt Rating at +85°C (2.7 Volt Rating at +125°C)					
68.0	*C	T496C686(1)004AS	2.7	6.0	1.6
100.0	*C	T496C107(1)004AS	4.0	8.0	1.2
150.0	D	T496D157(1)004AS	6.0	8.0	0.8
220.0	*D	T496D227(1)004AS	8.8	8.0	0.7
#330.0	*D	T496D337(1)004AS	13.2	8.0	0.7
330.0	*X	T496X337(1)004AS	13.2	8.0	0.7
#470.0	*X	T496X477(1)004AS	18.8	8.0	0.5
**6 Volt Rating at +85°C (4 Volt Rating at +125°C)					
4.7	B	T496B475(1)006AS	0.5	6.0	3.5
6.8	B	T496B685(1)006AS	0.5	6.0	3.5
10.0	B	T496B106(1)006AS	0.6	6.0	3.5
22.0	B	T496B226(1)006AS	1.3	6.0	3.5
15.0	C	T496C156(1)006AS	0.9	6.0	2.0
22.0	C	T496C226(1)006AS	1.4	6.0	2.0
33.0	C	T496C336(1)006AS	2.0	6.0	2.0
47.0	D	T496D476(1)006AS	2.9	6.0	1.0
47.0	*C	T496C476(1)006AS	2.9	6.0	1.6
68.0	D	T496D686(1)006AS	4.1	6.0	1.0
#68.0	*C	T496C686(1)006AS	4.1	6.0	1.2
100.0	X	T496X107(1)006AS	6.0	8.0	0.9
100.0	D	T496D107(1)006AS	6.0	8.0	0.8
150.0	*D	T496D157(1)006AS	9.0	8.0	0.7
#220.0	*D	T496D227(1)006AS	13.2	8.0	0.7
220.0	*X	T496X227(1)006AS	13.2	8.0	0.7
#330.0	*X	T496X337(1)006AS	19.8	8.0	0.5
10 Volt Rating at +85°C (7 Volt Rating at +125°C)					
3.3	B	T496B335(1)010AS	0.5	6.0	3.5
4.7	B	T496B475(1)010AS	0.5	6.0	3.5
6.8	B	T496B685(1)010AS	0.7	6.0	3.5
15.0	B	T496B156(1)010AS	1.5	6.0	3.5
10.0	C	T496C106(1)010AS	1.0	6.0	2.0
15.0	C	T496C156(1)010AS	1.5	6.0	2.0
22.0	C	T496C226(1)010AS	2.2	6.0	2.0
33.0	D	T496D336(1)010AS	3.3	6.0	1.0
33.0	*C	T496C336(1)010AS	3.3	6.0	1.6
47.0	D	T496D476(1)010AS	4.7	6.0	1.0
#47.0	*C	T496C476(1)010AS	4.7	6.0	1.2
68.0	X	T496X686(1)010AS	6.8	6.0	0.9
68.0	D	T496D686(1)010AS	6.8	6.0	0.8
100.0	D	T496D107(1)010AS	10.0	8.0	0.7
150.0	*X	T496X157(1)010AS	15.0	8.0	0.7
#150.0	*D	T496D157(1)010AS	15.0	8.0	0.7
#220.0	*X	T496X227(1)010AS	22.0	8.0	0.5
16 Volt Rating at +85°C (10 Volt Rating at +125°C)					
2.2	B	T496B225(1)016AS	0.5	6.0	3.5
3.3	B	T496B335(1)016AS	0.5	6.0	3.5
4.7	B	T496B475(1)016AS	0.8	6.0	3.5
10.0	B	T496B106(1)016AS	1.6	6.0	3.5
6.8	C	T496C685(1)016AS	1.1	6.0	2.0
10.0	C	T496C106(1)016AS	1.6	6.0	2.0
15.0	C	T496C156(1)016AS	2.4	6.0	2.0
22.0	D	T496D226(1)016AS	3.6	6.0	1.0
22.0	*C	T496C226(1)016AS	3.6	6.0	1.6
33.0	D	T496D336(1)016AS	5.3	6.0	1.0
47.0	X	T496X476(1)016AS	7.5	6.0	0.9
47.0	D	T496D476(1)016AS	7.5	6.0	0.8
100.0	*X	T496X107(1)016AS	16.0	8.0	0.7

** Note: 6V rating equivalent to 6.3 rating *Extended Ratings
Maximum capacitance change @ 125°C = +15% (all others =12%)

T496 SERIES CONSTRUCTION

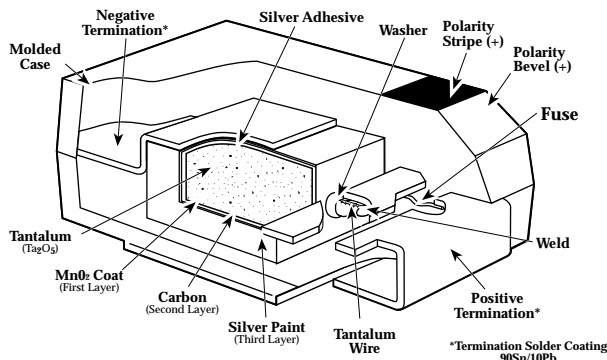

Capacitance μF	Case Size	KEMET Part Number	DCL μA @ +25°C Max.	DF % @ +25°C 120 Hz. Max.	ESR Ω @ +25°C 100 kHz Max.
20 Volt Rating at +85°C (13 Volt Rating at +125°C)					
1.5	B	T496B155(1)020AS	0.5	6.0	5.0
2.2	B	T496B225(1)020AS	0.5	6.0	3.5
3.3	B	T496B335(1)020AS	0.7	6.0	3.5
4.7	C	T496C475(1)020AS	1.0	6.0	2.0
6.8	C	T496C685(1)020AS	1.4	6.0	2.0
10.0	C	T496C106(1)020AS	2.0	6.0	2.0
15.0	D	T496D156(1)020AS	3.0	6.0	1.0
22.0	D	T496D226(1)020AS	4.4	6.0	1.0
33.0	X	T496X336(1)020AS	6.6	6.0	0.9
25 Volt Rating at +85°C (17 Volt Rating at +125°C)					
0.68	B	T496B684(1)025AS	0.5	4.0	6.5
1.0	B	T496B105(1)025AS	0.5	4.0	5.0
1.5	B	T496B155(1)025AS	0.5	6.0	5.0
2.2	C	T496C225(1)025AS	0.6	6.0	3.5
3.3	C	T496C335(1)025AS	0.9	6.0	2.5
4.7	C	T496C475(1)025AS	1.2	6.0	2.5
6.8	C	T496C685(1)025AS	1.7	6.0	2.0
10.0	D	T496D106(1)025AS	2.5	6.0	1.2
15.0	D	T496D156(1)025AS	3.8	6.0	1.0
22.0	X	T496X226(1)025AS	5.5	6.0	0.9
22.0	D	T496D226(1)025AS	5.5	6.0	0.8
35 Volt Rating at +85°C (23 Volt Rating at +125°C)					
0.47	B	T496B474(1)035AS	0.5	4.0	8.0
0.68	B	T496B684(1)035AS	0.5	4.0	6.5
1.0	B	T496B105(1)035AS	0.5	4.0	5.0
1.5	C	T496C155(1)035AS	0.5	6.0	4.5
2.2	C	T496C225(1)035AS	0.8	6.0	3.5
3.3	C	T496C335(1)035AS	1.2	6.0	2.5
4.7	D	T496D475(1)035AS	1.7	6.0	1.5
6.8	D	T496D685(1)035AS	2.4	6.0	1.3
10.0	X	T496X106(1)035AS	3.5	6.0	1.0
15.0	*X	T496X156(1)035AS	5.3	6.0	0.9
50 Volt Rating at +85°C (33 Volt Rating at +125°C)					
0.15	B	T496B154(1)050AS	0.5	4.0	16.0
0.22	B	T496B224(1)050AS	0.5	4.0	14.0
0.33	B	T496B334(1)050AS	0.5	4.0	10.0
0.47	C	T496C474(1)050AS	0.5	4.0	8.0
0.68	C	T496C684(1)050AS	0.5	4.0	7.0
1.0	C	T496C105(1)050AS	0.5	4.0	5.5
1.5	C	T496C155(1)050AS	0.8	6.0	5.0
2.2	D	T496D225(1)050AS	1.1	6.0	2.5
3.3	D	T496D335(1)050AS	1.7	6.0	2.0
4.7	X	T496X475(1)050AS	2.4	6.0	1.5

(1) To complete KEMET Part Number, insert M for ±20% tolerance or K for ±10% tolerance.

Higher voltage ratings and tighter capacitance tolerance product may be substituted within the same size at KEMET's option. Voltage substitutions will be marked with the higher voltage rating.

CAPACITOR MARKINGS

T496 Series — All Case Sizes

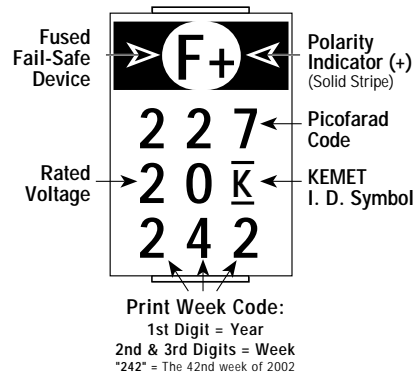

FEATURES

- Ultra Low ESR < 30 mΩ
- New E/7260 Case with ESR < 18 mΩ
- Up to 4 Amps ripple current
- 100% accelerated steady-state aging
- 100% Surge current test
- Precision - molded, laser-marked case
- Symmetrical compliant terminations
- Taped and reeled per EIA 481-1

OUTLINE DRAWING

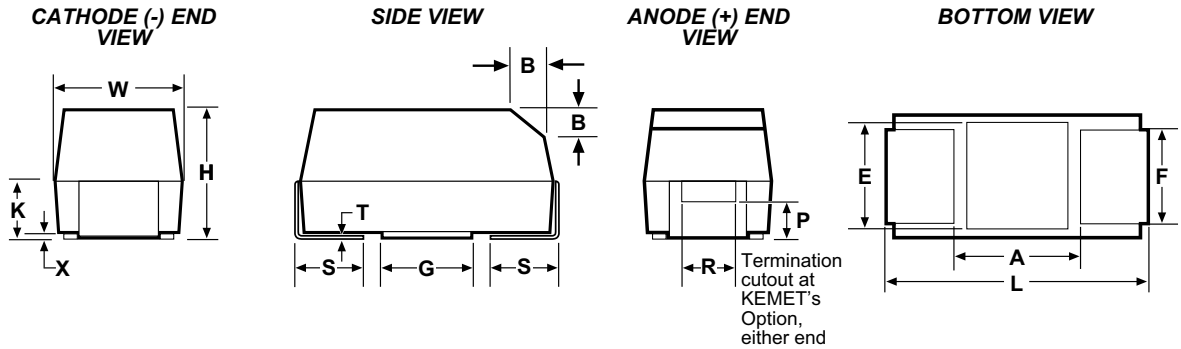

DIMENSIONS - Millimeters (Inches)

CASE SIZE		COMPONENT													
KEMET	EIA	L	W	H	K ± 0.20 $\pm (.008)$	F ± 0.1 $\pm (.004)$	S ± 0.3 $\pm (.012)$	B ± 0.15 $(\text{Ref}) \pm (.006)$	X (Ref)	P (Ref)	R (Ref)	T (Ref)	A (Min)	G (Ref)	E (Ref)
X	7343-43	7.3 ± 0.3 (.287 $\pm .012$)	4.3 ± 0.3 (.169 $\pm .012$)	4.0 ± 0.3 (.157 $\pm .012$)	2.3 (.091)	2.4 (.094)	1.3 (.051)	0.5 (.020)	0.10 ± 0.10 (.004 $\pm .004$)	0.9 (.035)	1.0 (.039)	0.13 (.005)	3.8 (.150)	3.5 (.138)	3.5 (.138)
E	7260-38	7.3 ± 0.3 (.287 $\pm .012$)	6.0 ± 0.3 (.236 $\pm .012$)	3.6 ± 0.2 (.142 $\pm .008$)	2.3 (.091)	4.1 (.161)	1.3 (.051)	0.5 (.020)	0.10 ± 0.10 (.004 $\pm .004$)	0.9 (.035)	1.0 (.039)	0.13 (.005)	3.8 (.150)	3.5 (.138)	3.5 (.138)

Notes: Metric Dimensions govern
(Ref) - Dimensions provided for reference only.

T510 RATINGS & PART NUMBER REFERENCE

Capacitance μF	Case Size	KEMET Part Number	DC Leakage μA @ 25°C Max	DF % @ 25°C Max	ESR m W @ 25°C 100 kHz Max	Ripple Current A rms @ 25°C 100 kHz, max		
						25°C	85°C	125°C
4 Volt Rating at +85°C (2.7 Volt Rating at 125°C)								
680.0	X	T510X687(1)004AS	27.2	6.0	30.0	3.0	2.7	1.2
1000.0	E	T510E108(1)004AS	40.0	6.0	18.0	4.0	3.6	1.6
1000.0	E	T510E108(1)004AS4115	40.0	6.0	10.0	5.3	4.8	2.1
6/6.3 Volt Rating at +85°C (4 Volt Rating at 125°C)								
470.0	X	T510X477(1)006AS	28.2	6.0	30.0	3.0	2.7	1.2
680.0	E	T510E687(1)006AS	40.8	6.0	23.0	3.5	3.2	1.4
680.0	E	T510E687(1)006AS4115	40.8	6.0	12.0	4.8	4.3	1.9
10 Volt Rating at +85°C (7 Volt Rating at 125°C)								
330.0	X	T510X337(1)010AS	33.0	6.0	35.0	2.8	2.5	1.1
25 Volt Rating at +85°C (17 Volt Rating at 125°C)								
100.0	E	T510E107(1)025AS	25.0	8.0	50.0	2.4	2.1	1.0

T510 ORDERING INFORMATION

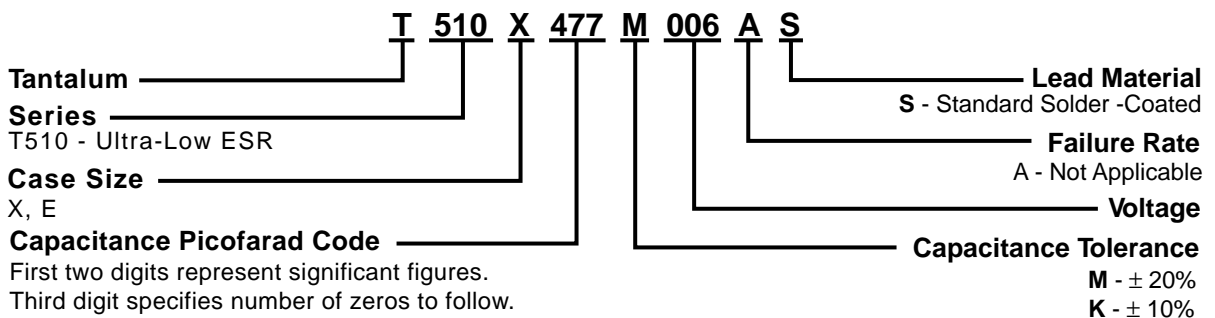

TYPICAL CAP FREQUENCY SCAN @25°C
T510X477M006AS

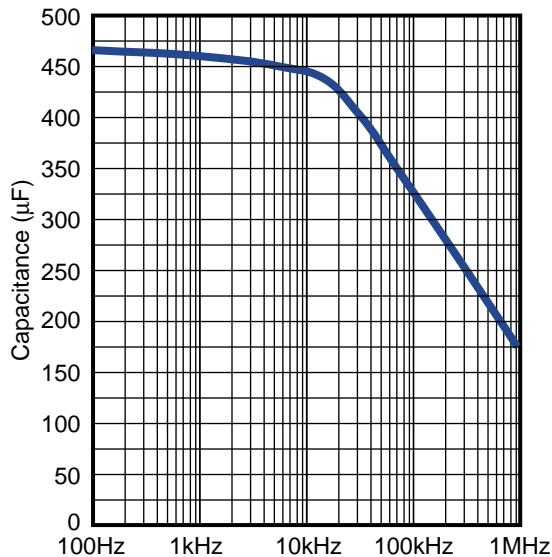

TYPICAL ESR/Z FREQUENCY SCAN @25°C
T510X477M006AS

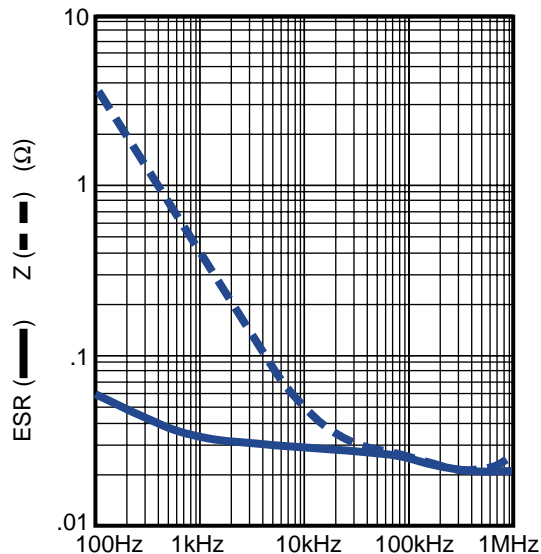

Solid Tantalum Surface Mount

CAPACITOR MARKINGS

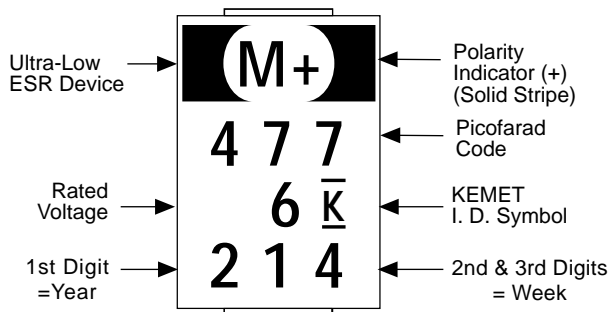

"214" = The 14th week of 2002.

T510 SERIES CONSTRUCTION

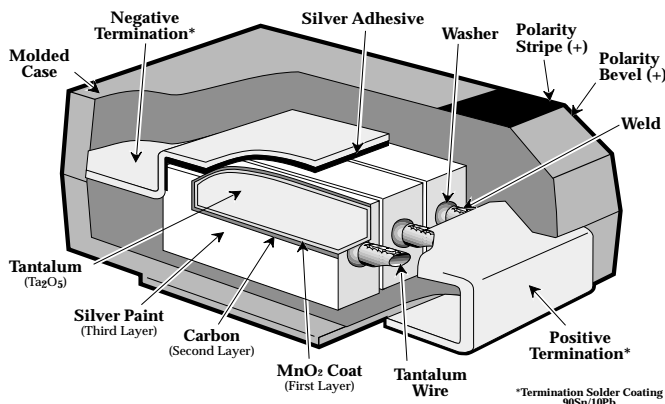

TYPICAL CAP FREQUENCY SCAN @ 25°C
T510E108M004AS

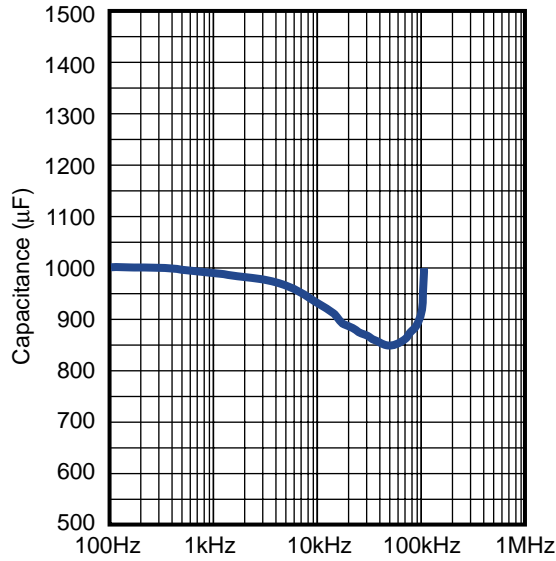

TYPICAL ESR/Z FREQUENCY SCAN @ 25°C
T510E108M004AS

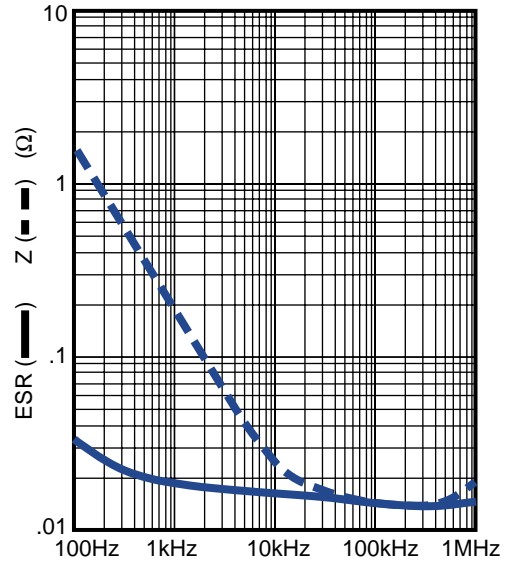

CAPACITOR MARKINGS

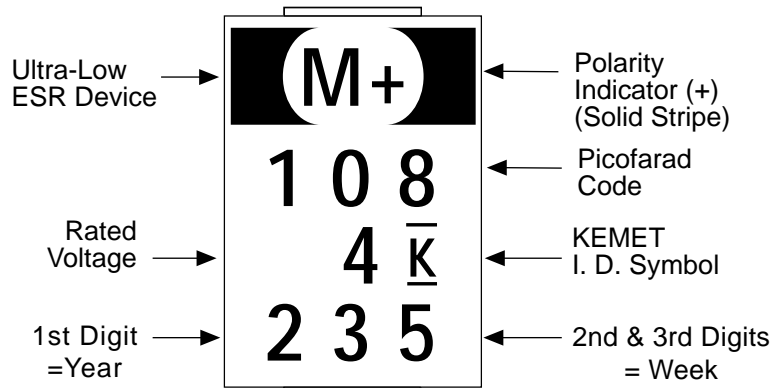

"235" = The 35th week of 2002.

T510E SERIES CONSTRUCTION



COMPONENT PERFORMANCE CHARACTERISTICS

Introduction

KEMET has developed a new type of tantalum capacitor that replaces the solid manganese dioxide electrode with a solid conductive polymer. This product is named the KO-CAP for **KEMET Organic Capacitor**. The basic families are the T520 and T530 series. A separate detail of performance characteristics is presented here as there are some differences between the polymer tantalums and the standard MnO₂ types. Like all KEMET tantalum chips, these series are 100% screened for all electrical parameters: Capacitance @ 120 Hz, Dissipation Factor (DF) @ 120 Hz, ESR @ 100 kHz and DC Leakage. It is also 100% surge current tested at full rated voltage through a low impedance circuit. The advantages of the polymer include very low ESR and elimination of the potentially catastrophic failure mode that may occur with standard tantalum capacitors in a high surge current application. Although the natural KO-CAP series failure mechanism is a short circuit, it does not exhibit an explosive failure mode.

ELECTRICAL

1. Operating Temperature Range

- -55°C to +105°C

Above 85°C, the voltage rating is reduced linearly from 1.0 x rated voltage to 0.8 x rated voltage at 105°C.

2. Non-Operating Temperature Range

- -55°C to +105°C

3. Capacitance and Tolerance

- 33µF to 1500µF
- ±20% Tolerance

Capacitance is measured at 120 Hz, up to 1.0 volt rms maximum and up to 2.5V DC maximum. DC bias causes only a small reduction in capacitance, up to about 2% when full rated voltage is applied. DC bias is not commonly used for room temperature measurements but is more commonly used when measuring at temperature extremes.

Capacitance does decrease with increasing frequency, but not nearly as much or as quickly as standard tantalums. Figure 1 compares the frequency induced cap roll-off between the KO-CAP and traditional MnO₂ types. Capacitance also increases with increasing temperature. See section 12 for temperature coefficients.

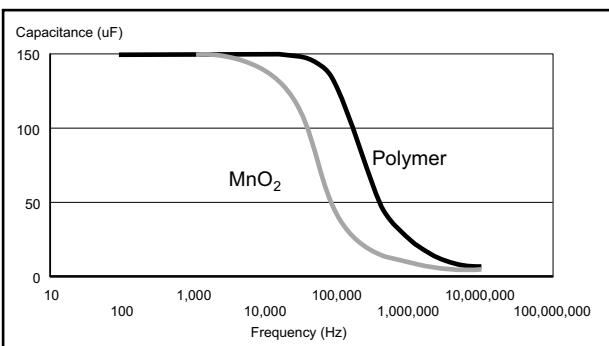

FIGURE 1

4. Voltage Ratings

- 2V-16V DC Rated Voltage

This is the maximum peak DC operating voltage from -55°C to +85°C for continuous duty. Above 85°C, this voltage is derated linearly to 0.8 times the rated voltage for operation at 105°C.

- Surge Voltage Ratings

Surge voltage is the maximum voltage to which the part can be subjected under transient conditions including the sum of peak AC ripple, DC bias and any transients. Surge voltage capability is demonstrated by application of 1000 cycles of the relevant voltage, at 25°C, 85°C or 105°C. The parts are charged through a 33 ohm resistor for 30 seconds and then discharged through a 33 ohm resistor for 30 seconds for each cycle.

• Voltage Ratings • Table 1

Rated Voltage	Surge Voltage	Derated Voltage	Derated Surge Voltage
-55°C to +85°C		+105°C	
2V	2.6V	1.6V	2.1V
2.5V	3.3V	2.0V	2.8V
3V	3.9V	2.4V	3.1V
4V	5.2V	3.3V	4.3V
6.3V	8V	5V	6.5V
8V	10.4V	6.4V	8.7V
10V	13V	8V	10.4V
16V	20.8V	12.8V	16.6V

5. Reverse Voltage Rating & Polarity

Polymer tantalum capacitors are polar devices and may be permanently damaged or destroyed if connected in the wrong polarity. The positive terminal is identified by a laser-marked stripe and may also include a beveled edge. These capacitors will withstand a small degree of transient voltage reversal for short periods as shown in the following table. Please note that these parts may not be operated continuously in reverse, even within these limits.

Table 2

Temperature	Permissible Transient Reverse Voltage
25°C	15% of Rated Voltage
55°C	10% of Rated Voltage
85°C	5% of Rated Voltage
105°C	3% of Rated Voltage

6. DC Leakage Current

Because of the high conductivity of the polymer, the KO-CAP family has higher leakage currents than traditional MnO₂ type Tantalum caps. The DC Leakage limits at 25°C are calculated as 0.1 x C x V, where C is cap in µF and V is rated voltage in Volts. Limits for all part numbers are listed in the ratings tables.

DC Leakage current is the current that flows through the capacitor dielectric after a five minute charging period at rated voltage. Leakage is measured at 25°C with full rated voltage applied to the capacitor through a 1000 ohm resistor in series with the capacitor.

COMPONENT PERFORMANCE CHARACTERISTICS

DC Leakage current does increase with temperature. The limits for 85°C @ Rated Voltage and 105°C @ 0.8 x Rated Voltage are both 10 times the 25°C limit.

7. Surge Current Capability

Certain applications may induce heavy surge currents when circuit impedance is very low (<0.1 ohm per volt). Driving inductance may also cause voltage ringing. Surge currents may appear as transients during turn-on of equipment.

The KO-CAP has a very high tolerance for surge current. And although the failure mechanism is a short circuit, they do not explode as may occur with standard tantalums in such applications.

The KO-CAP series receives 100% screening for surge current in our production process. Capacitors are surged 4 times at full rated voltage applied through a total circuit resistance of <0.5 ohms. Failures are removed during subsequent electrical testing.

8. Dissipation Factor (DF)

Refer to part number tables for maximum DF limits.

Dissipation factor is measured at 120 Hz, up to 1.0 volt rms maximum, and up to 2.5 volts DC maximum at +25°C. The application of DC bias causes a small reduction in DF, about 0.2% when full rated voltage is applied. DF increases with increasing frequency.

Dissipation factor is the ratio of the equivalent series resistance (ESR) to the capacitive reactance, (X_c) and is usually expressed as a percentage. It is directly proportional to both capacitance and frequency. Dissipation factor loses its importance at higher frequencies, (above about 1 kHz), where impedance (Z) and equivalent series resistance (ESR) are the normal parameters of concern.

$$DF = \frac{R}{X_c} = 2 \pi f CR$$

DF = Dissipation Factor
 R = Equivalent Series Resistance (Ohms)
 X_c = Capacitive Reactance (Ohms)
 f = Frequency (Hertz)
 C = Series Capacitance (Farads)

DF is also referred to as $\tan \delta$ or "loss tangent." The "Quality Factor," "Q," is the reciprocal of DF.

9. Equivalent Series Resistance (ESR) and Impedance (Z)

The Equivalent Series Resistance (ESR) of the KO-CAP is much lower than standard Tantalum caps because the polymer cathode has much higher conductivity. ESR is not a pure resistance, and it decreases with increasing frequency.

Total impedance of the capacitor is the vector sum of capacitive reactance (X_c) and ESR, below resonance; above resonance total impedance is the vector sum of inductive reactance (X_L) and ESR.

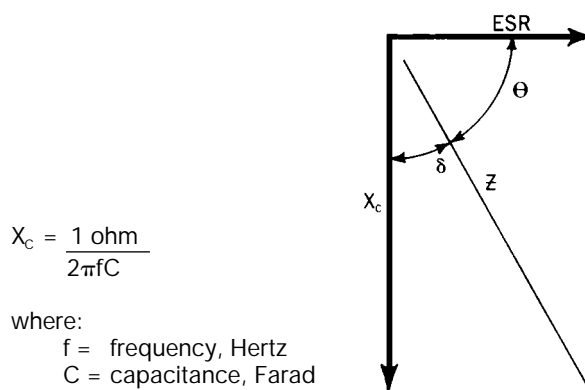

FIGURE 2a Total Impedance of the Capacitor Below Resonance

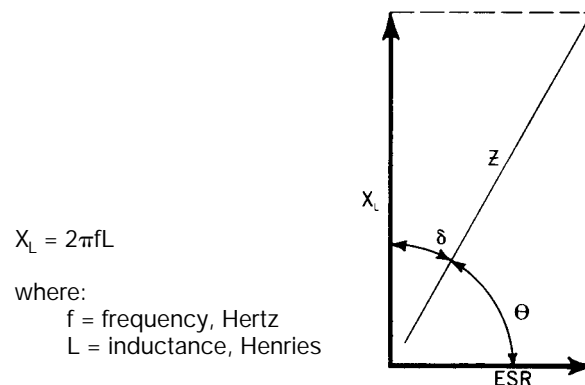

FIGURE 2b Total Impedance of the Capacitor Above Resonance

To understand the many elements of a capacitor, see Figure 3.

COMPONENT PERFORMANCE CHARACTERISTICS

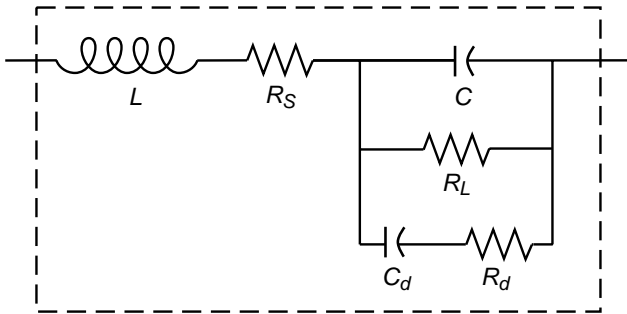

FIGURE 3 The Real Capacitor

A capacitor is a complex impedance consisting of many series and parallel elements, each adding to the complexity of the measurement system.

L — Represents lead wire and construction inductance. In most instances (especially in solid tantalum and monolithic ceramic capacitors) it is insignificant at the basic measurement frequencies of 120 and 1000 Hz.

R_s — Represents the actual ohmic series resistance in series with the capacitance. Lead wires and capacitor electrodes are contributing sources.

R_L — Capacitor Leakage Resistance. Typically it can reach 50,000 megohms in a tantalum capacitor. It can exceed 10^{12} ohms in monolithic ceramics and in film capacitors.

R_d — The dielectric loss contributed by dielectric absorption and molecular polarization. It becomes very significant in high frequency measurements and applications. Its value varies with frequency.

C_d — The inherent dielectric absorption of the solid tantalum capacitor which typically equates to 1-2% of the applied voltage.

As frequency increases, X_c continues to decrease according to its equation above. There is unavoidable inductance as well as resistance in all capacitors, and at some point in frequency, the reactance ceases to be capacitive and becomes inductive. This frequency is called the self-resonant point. In solid tantalum capacitors, the resonance is damped by the ESR, and a smooth, rather than abrupt, transition from capacitive to inductive reactance follows.

Figure 4 compares the frequency response of a KO-CAP to a standard Tantalum chip. See also frequency curves shown in the T520 section, p.39. Maximum limits for 100 kHz ESR are listed in the part number tables for each series.

The T530 Capacitance, Impedance and ESR vs. Frequency Comparisons are located on page 43. Maximum limits for 100 kHz are listed in the part number table on page 42.

ESR and Impedance

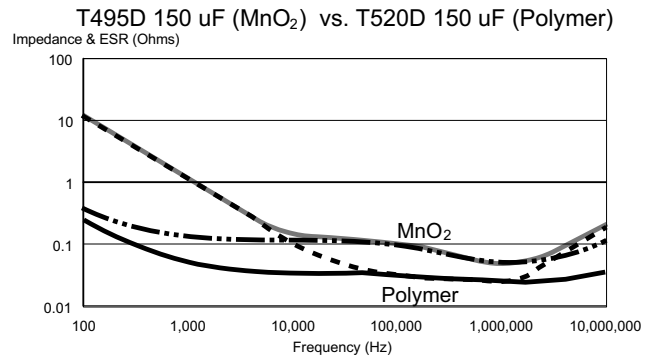

FIGURE 4

10. AC Power Dissipation

Power dissipation is a function of capacitor size and materials. Maximum power ratings have been established for all case sizes to prevent overheating. In actual use, the capacitor's ability to dissipate the heat generated at any given power level may be affected by a variety of circuit factors. These include board density, pad size, heat sinks and air circulation.

Table 3
Tantalum Chip Power Dissipation Ratings

Case Code		Maximum Power Dissipation mWatts @ +25°C w/+20°C Rise
KEMET	EIA	
T520/T	3528-12	70
T520/B	3528-21	85
T520/V	7343-20	125
T520/D	7343-31	150
T520/Y	7343-40	156
T520/X	7343-43	165
T530/D	7343-31	255
T530/X	7343-43	270
T530/E	7260-38	285

11. AC Operation

Permissible AC ripple voltage and current are related to equivalent series resistance (ESR) and power dissipation capability.

Permissible AC ripple voltage which may be applied is limited by three criteria:

- The positive peak AC voltage plus the DC bias voltage, if any, must not exceed the DC voltage rating of the capacitor.
- The negative peak AC voltage, in combination with bias voltage, if any, must not exceed the permissible reverse voltage ratings presented in Section 5.
- The power dissipated in the ESR of the capacitor must not exceed the appropriate value specified in Section 10.

COMPONENT PERFORMANCE CHARACTERISTICS

Actual power dissipated may be calculated from the following:

$$P = I^2R$$

$$\text{Substituting } I = \frac{E}{Z} \quad P = \frac{E^2R}{Z^2}$$

where:

I = rms ripple current (amperes)

E = rms ripple voltage (volts)

P = power (watts)

Z = impedance at specified frequency (ohms)

R = equivalent series resistance at specified frequency (ohms)

Using P max from Table 3, maximum allowable rms ripple current or voltage may be determined as follows:

$$I(\text{max}) = \sqrt{P \text{ max}/R} \quad E(\text{max}) = Z \sqrt{P \text{ max}/R}$$

These values should be derated at elevated temperatures as follows:

Temperature	Derating Factor
85°C	.9
105°C	.4

ENVIRONMENTAL

12. Temperature Stability

Mounted capacitors withstand extreme temperature testing at a succession of continuous steps at +25°C, -55°C, +25°C, +85°C, +105°C, +25°C in that order. Capacitors are allowed to stabilize at each temperature before measurement. Cap, DF, and DCL are measured at each temperature except DC Leakage is not measured at -55°C.

Table 4

Acceptable limits are as follows:

Step	Temp.	ΔCap	DCL	DF
1	+25°C	Specified Tolerance	Catalog Limit	Catalog Limit
2	-55°C	±20% of initial value	N/A	Catalog Limit
3	+25°C	±10% of initial value	Catalog Limit	Catalog Limit
4	+85°C	±20% of initial value	10x Catalog Limit	1.2x Catalog Limit
5	+105°C	±30% of initial value	10x Catalog Limit	1.5x Catalog Limit
6	+25°C	±10% of initial value	Catalog Limit	Catalog Limit

13. Standard Life Test

• **85°C, Rated Voltage, 2000 Hours**

Post Test Performance:

- Capacitance: within -20%/+10% of initial value
- DF: within initial limit
- DC Leakage: within initial limit
- ESR: within initial limit

14. High Temperature Life Test

• **105°C, 0.8 x Rated Voltage, 2000 hours**

Post Test Performance:

- Capacitance: within -20%/+10% of initial value
- DF: within initial limit
- DC Leakage: within 1.25 x initial limit
- ESR: within 2 x initial limit

15. Storage Life Test

• **105°C, 0VDC, 2000 Hours**

Post Test Performance:

- Capacitance: within -20%/+10% of initial value
- DF: within initial limit
- DC Leakage: within 1.25 x initial limit
- ESR: within 2 x initial limit

16. Thermal Shock

• **Mil-Std-202, Method 107, Condition B**

Minimum temperature is -55°C

Maximum temperature is +105°C

500 Cycles

Post Test Performance:

- Capacitance: within +10%/-20% of initial value
- DF: within initial limit
- DC Leakage: within initial limit
- ESR: within 2 x initial limit

17. Moisture Resistance Testing

• **J-Std-020**

Steps 7a and 7b excluded, 0V, 21 cycles

Post Test Performance:

- Capacitance: within ±30% of initial value
- DF: within initial limit
- DC Leakage: within initial limit
- ESR: within initial limit

18. Load Humidity

• **85°C, 85% RH, Rated Voltage, 500 Hours**

Post Test Performance:

- Capacitance: within +35%/-5% of initial value
- DF: within initial limit
- DC Leakage: within 5 x initial limit
- ESR: within 2 x initial limit

19. ESD

• **Polymer tantalum capacitors are not sensitive to Electro-Static Discharge (ESD).**

20. Failure Mechanism and Reliability

The normal failure mechanism is dielectric breakdown. Dielectric failure can result in high DC Leakage current and may proceed to the level of a short circuit. With sufficient time to charge, healing may occur by one of two potential mechanisms. The polymer adjacent to the dielectric fault site may overheat and vaporize, disconnecting the fault site from the circuit. The polymer may also

COMPONENT PERFORMANCE CHARACTERISTICS

oxidize into a more resistive material that plugs the defect site in the dielectric and reduces the flow of current.

Capacitor failure may be induced by exceeding the rated conditions of forward DC voltage, reverse DC voltage, surge current, power dissipation or temperature. Excessive environmental stress, such as prolonged or high temperature reflow processes may also trigger dielectric failure.

Failure rates may be improved in application by derating the voltage applied to the capacitor. KEMET recommends that KO-CAPs be derated to 80% or less of the rated voltage in application.

KO-CAPs exhibit a benign failure mode in that they do not fail catastrophically even under typical fault conditions. If a shorted capacitor is allowed to pass unlimited current, it may overheat and the case may discolor. But this is distinctly different from the explosive "ignition" that may occur with standard MnO₂ cathode tantalums. Replacement of the MnO₂ by the polymer removes the oxygen that fuels ignition during a failure event.

MECHANICAL

21. Resistance to Solvents

- *Mil-Std-202, Method 215*

Post Test Performance:

- a. Capacitance — within ±10% of initial value
- b. DC Leakage — within initial limit
- c. Dissipation Factor — within initial limit
- d. ESR — within initial limit
- e. Physical — no degradation of case, terminals or marking

22. Fungus

- *Mil-Std-810, Method 508*

23. Flammability

- *UL94 VO Classification*

Encapsulant materials meet this classification

24. Resistance to Soldering Heat

- *Maximum Reflow*
+240 ±5°C, 10 seconds
- *Typical Reflow*
+230 ±5°C, 30 seconds

Post Test Performance:

- a. Capacitance — within ±10% of initial value
- b. DC Leakage — within initial limit
- c. Dissipation Factor — within initial limit
- d. ESR — within initial limit

25. Solderability

- *Mil-Std-202, Method 208*
- *ANSI/J-STD-002, Test B*

Applies to Solder Coated terminations only.

26. Vibration

- *Mil-Std-202, Method 204, Condition D, 10 Hz to 2,000 Hz, 20G Peak*

Post Test Performance:

- a. Capacitance — within ±10% of initial value
- b. DC Leakage — within initial limit
- c. Dissipation Factor — within initial limit
- d. ESR — within initial limit

27. Shock

- *Mil-Std-202, Method 213, Condition I, 100 G Peak*

Post Test Performance:

- a. Capacitance — within ±10% of initial value
- b. DC Leakage — within initial limit
- c. Dissipation Factor — within initial limit
- d. ESR - within initial limit

28. Terminal Strength

- **Pull Force**

- *One Pound (454 grams), 30 Seconds*

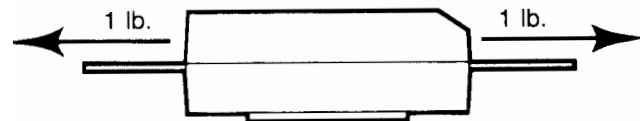

- **Tensile Force**

- *Four Pounds (1.8 kilograms), 60 Seconds*

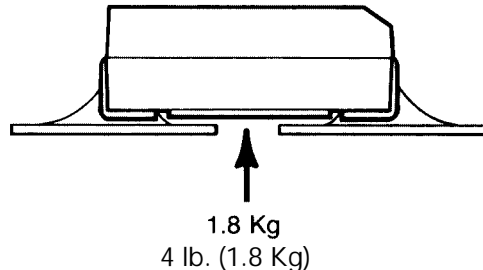

- **Shear Force**

Table 5 Maximum Shear Loads

Case Code		Maximum Shear Loads	
KEMET	EIA	Kilograms	Pounds
B	3528-21	3.6	8.0
V	7343-20	5.0	11.0
D	7343-31	5.0	11.0
X	7343-43	5.0	11.0

Post Test Performance:

- a. Capacitance — within ±5% of initial value
- b. DC Leakage — within initial limit
- c. Dissipation Factor — within initial limit
- d. ESR - within initial limit

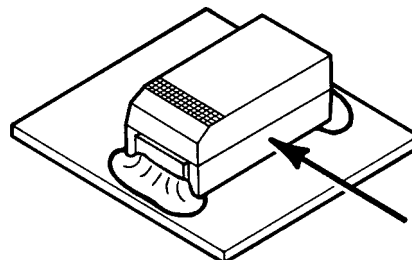

COMPONENT PERFORMANCE CHARACTERISTICS APPLICATIONS

29. Handling

Automatic handling of encapsulated components is enhanced by the molded case which provides compatibility with all types of high speed pick and place equipment. Manual handling of these devices presents no unique problems. Care should be taken with your fingers, however, to avoid touching the solder-coated terminations as body oils, acids and salts will degrade the solderability of these terminations. Finger cots should be used whenever manually handling all solderable surfaces.

30. Termination Coating

The standard finish coating is 90/10 Sn/Pb solder (Tin/Lead-solder coated). 100% tin coating is available upon request.

31. Recommended Mounting Pad Geometries

Proper mounting pad geometries are essential for successful solder connections. These dimensions are highly process sensitive and should be designed to maximize the integrity of the solder joint, and to minimize component rework due to unacceptable solder joints.

Figure 5 illustrates pad geometry. The table provides recommended pad dimensions for reflow soldering techniques. These dimensions are intended to be a starting point for circuit board designers, to be fine tuned, if necessary, based upon the peculiarities of the soldering process and/or circuit board design.

Contact KEMET for Engineering Bulletin Number F-2100 entitled "Surface Mount Mounting Pad Dimensions and Considerations" for further details on this subject.

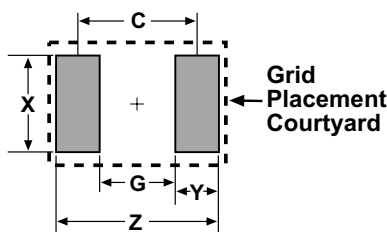

Figure 5

Table 6 - Land Pattern Dimensions for Reflow Solder

KEMET/EIA Size Code	Pad Dimensions				
	Z	G	X	Y (ref)	C (ref)
B/3528-21	5.00	1.10	2.50	1.95	3.05
D/7343-31, V/7343-20, X/7343-43	8.90	3.80	2.70	2.55	6.35

32. Soldering

The T520 KO-CAP family has been designed for reflow solder processes. They are not recommended for wave solder. Solder-coated terminations have excellent wetting characteristics for

high integrity solder fillets. Preheating of these components is recommended to avoid extreme thermal stress. The maximum recommended preheat rate is 2°C per second.

Hand-soldering should be avoided. If necessary, it should be performed with care due to the difficulty in process control. Care should be taken to avoid contact of the soldering iron to the molded case. The iron should be used to heat the solder pad, applying solder between the pad and the termination, until reflow occurs. The iron should be removed. "Wiping" the edges of a chip and heating the top surface is not recommended.

During typical reflow operations a slight darkening of the gold-colored epoxy may be observed. This slight darkening is normal and is not harmful to the product. Marking permanency is not affected by this change.

33. Washing

Standard washing techniques and solvents are compatible with all KEMET surface mount tantalum capacitors. Solvents such as Freon TMC and TMS, Trichlorethane, methylene chloride, prelete, and isopropyl alcohol are not harmful to these components. Please note that we are not endorsing the use of banned or restricted solvents. We are simply stating that they would not be harmful to the components.

If ultrasonic agitation is utilized in the cleaning process, care should be taken to minimize energy levels and exposure times to avoid damage to the terminations.

KEMET tantalum chips are also compatible with newer aqueous and semi-aqueous processes.

34. Encapsulations

Under normal circumstances, potting or encapsulation of KEMET tantalum chips is not required.

35. Storage Environment

Tantalum chip capacitors should be stored in normal working environments. While the chips themselves are quite robust in other environments, solderability will be degraded by exposure to high temperatures, high humidity, corrosive atmospheres, and long term storage. In addition, packaging materials will be degraded by high temperature - reels may soften or warp, and tape peel force may increase. KEMET recommends that maximum storage temperature not exceed 40 degrees C, and the maximum storage humidity not exceed 60% relative humidity. In addition, temperature fluctuations should be minimized to avoid condensation on the parts, and atmospheres should be free of chlorine and sulfur bearing compounds. For optimized solderability, chip stock should be used promptly, preferably within 1.5 years of receipt.

FEATURES

- Polymer Cathode Technology
- Low ESR
- High Frequency Cap Retention
- No-Ignition Failure Mode
- Use Up to 80% of Rated Voltage (20% Derating)
- Capacitance 15 to 1000 μ F (\pm 20%)
- Voltage 2V to 25V
- EIA Standard Case Sizes
- 100% Surge Current Tested

OUTLINE DRAWING

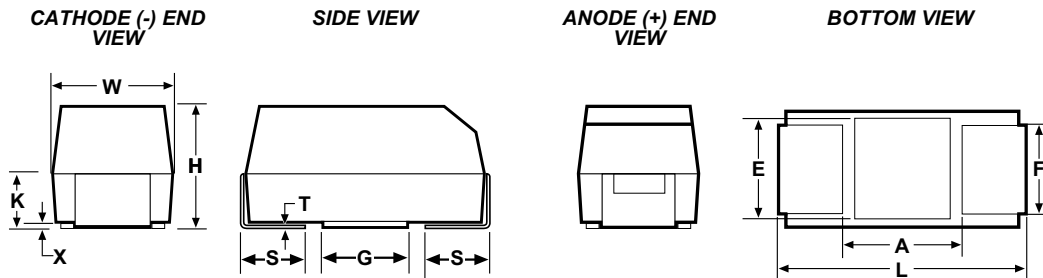

DIMENSIONS - MILLIMETERS

Case Size		L	W	H	K \pm 0.20	F \pm 0.1	S \pm 0.3	X(Ref)	T(Ref)	A(Min)	G(ref)	E(ref)
KEMET	EIA											
T	3528-12	3.5 \pm 0.2	2.8 \pm 0.2	1.2 max	0.3	2.2	0.8	0.05	0.13	1.1	1.8	2.2
B	3528-21	3.5 \pm 0.2	2.8 \pm 0.2	1.9 \pm 0.2	0.9	2.2	0.8	0.10 \pm 0.10	0.13	1.1	1.8	2.2
V	7343-20	7.3 \pm 0.3	4.3 \pm 0.3	1.9 max	0.9	2.4	1.3	0.05	0.13	3.8	3.5	3.5
D	7343-31	7.3 \pm 0.3	4.3 \pm 0.3	2.8 \pm 0.3	1.5	2.4	1.3	0.10 \pm 0.10	0.13	3.8	3.5	3.5
Y	7343-40	7.3 \pm 0.3	4.3 \pm 0.3	4.0 max	1.9	2.4	1.3	0.10 \pm 0.10	0.13	3.8	3.5	3.5
X	7343-43	7.3 \pm 0.3	4.3 \pm 0.3	4.0 \pm 0.3	2.3	2.4	1.3	0.10 \pm 0.10	0.13	3.8	3.5	3.5

T520 ORDERING INFORMATION

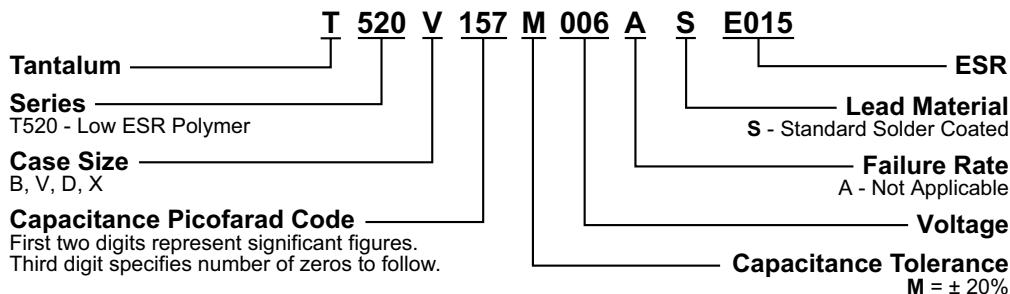

COMPONENT MARKING

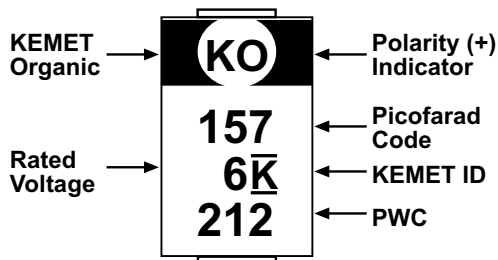

212 = 12th week of 2002

T520 SERIES CONSTRUCTION

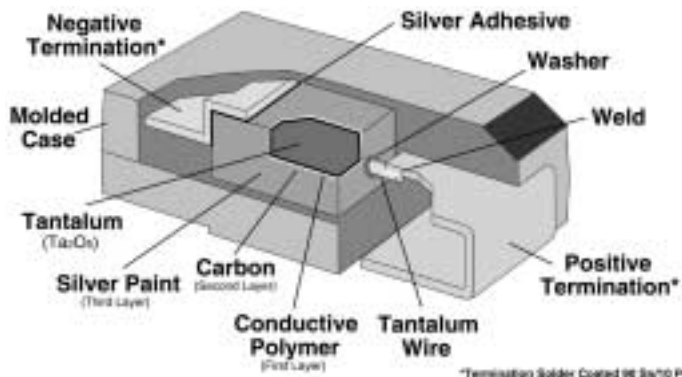

Polymer Tantalum Surface Mount

T520 RATINGS & PART NUMBER REFERENCE

Capacitance μ F	Case Size	KEMET Part Number	DC Leakage μ A @ 25°C Max	DF% @ 25°C 120 Hz Max	ESR mW @ 25°C 100 kHz Max	Ripple Current mA rms @ 25°C, 100 kHz Max		
						25°C	85°C	105°C
2 Volt Rating @ +85°C (1.6 Volt Rating at 105°C)								
470.0	V	T520V477M002ASE040	94	10	40	1.8	1.6	0.7
2.5 Volt Rating @ 85°C (2.0 Volt Rating at 105°C)								
56.0	T	T520T566M2R5ATE070	14	8	70	1.0	0.9	0.4
100.0	B	T520B107M2R5ASE040	25	8	40	1.5	1.3	0.6
100.0	B	T520B107M2R5ASE070	25	8	70	1.1	1.0	0.4
220.0	B	T520B227M2R5ASE035	55	8	35	1.6	1.4	0.6
220.0	B	T520B227M2R5ASE070	55	8	70	1.1	1.0	0.4
220.0	V	T520V227M2R5ASE009	55	10	9	3.7	3.4	1.5
220.0	V	T520V227M2R5ASE012	55	10	12	3.2	2.9	1.3
220.0	V	T520V227M2R5ASE015	55	10	15	2.9	2.6	1.2
220.0	V	T520V227M2R5ASE025	55	10	25	2.2	2.0	0.9
220.0	V	T520V227M2R5ASE045	55	10	45	1.7	1.5	0.7
330.0	V	T520V337M2R5ASE009	99	10	9	3.7	3.4	1.5
330.0	V	T520V337M2R5ASE015	83	10	15	2.9	2.6	1.2
330.0	V	T520V337M2R5ASE025	83	10	25	2.2	2.0	0.9
470.0	V	T520V477M2R5ASE009	118	10	9	3.7	3.4	1.5
470.0	V	T520V477M2R5ASE012	118	10	12	3.2	2.9	1.3
470.0	V	T520V477M2R5ASE015	118	10	15	2.9	2.6	1.2
470.0	D	T520D477M2R5ASE009	118	10	9	4.1	3.7	1.6
680.0	D	T520D687M2R5ASE010	170	10	10	3.9	3.5	1.5
680.0	D	T520D687M2R5ASE015	170	10	15	3.2	2.8	1.3
680.0	D	T520D687M2R5ASE040	170	10	40	1.9	1.7	0.8
680.0	Y	T520Y687M2R5ATE025	170	10	25	2.5	2.3	1.0
1000.0	Y	T520Y108M2R5ATE010	250	10	10	4.0	3.6	1.6
1000.0	Y	T520Y108M2R5ATE025	250	10	25	2.5	2.3	1.0
1000.0	X	T520X108M2R5ASE010	250	10	10	4.1	3.7	1.6
3 Volt Rating at 85°C (2.4 Volt Rating at 105°C)								
100.0	B	T520B107M003ASE040	30	8	40	1.5	1.3	0.6
100.0	B	T520B107M003ASE070	30	8	70	1.1	1.0	0.4
150.0	B	T520B157M003ASE040	45	8	40	1.5	1.3	0.6
150.0	B	T520B157M003ASE070	45	8	70	1.1	1.0	0.4
330.0	V	T520V337M003ASE012	99	10	12	3.2	2.9	1.3
330.0	V	T520V337M003ASE015	99	10	15	2.9	2.6	1.2
330.0	V	T520V337M003ASE025	99	10	25	2.2	2.0	0.9
680.0	D	T520D687M003ASE015	204	10	15	3.2	2.8	1.3
680.0	D	T520D687M003ASE040	204	10	40	1.9	1.7	0.8
1000.0	X	T520X108M003ASE015	300	10	15	3.3	3.0	1.3
1000.0	X	T520X108M003ASE030	300	10	30	2.3	2.1	0.9
4 Volt Rating @ +85°C (3.3 Volt Rating at +105°C)								
15.0	T	T520T156M004ATE100	6	8	100	0.8	0.7	0.3
47.0	T	T520T476M004ATE070	19	8	70	1	0.9	0.4
68.0	B	T520B686M004ASE040	27	8	40	1.5	1.3	0.6
68.0	B	T520B686M004ASE070	27	8	70	1.1	1.0	0.4
100.0	B	T520B107M004ASE040	40	8	40	1.5	1.3	0.6
100.0	B	T520B107M004ASE070	40	8	70	1.1	1.0	0.4
150.0	B	T520B157M004ASE035	60	8	35	1.6	1.4	0.6
150.0	B	T520B157M004ASE040	60	8	40	1.5	1.3	0.6
150.0	B	T520B157M004ASE070	60	8	70	1.1	1.0	0.4
150.0	V	T520V157M004ASE009	60	10	9	3.7	3.4	1.5
150.0	V	T520V157M004ASE012	60	10	12	3.2	2.9	1.3
150.0	V	T520V157M004ASE015	60	10	15	2.9	2.6	1.2
150.0	V	T520V157M004ASE025	60	10	25	2.2	2.0	0.9
220.0	V	T520V227M004ASE009	88	10	9	3.7	3.4	1.5
220.0	V	T520V227M004ASE012	88	10	12	3.2	2.9	1.3
220.0	V	T520V227M004ASE015	88	10	15	2.9	2.6	1.2
220.0	V	T520V227M004ASE025	88	10	25	2.2	2.0	0.9
220.0	V	T520V227M004ASE045	88	10	45	1.7	1.5	0.7
220.0	D	T520D227M004ASE065	88	10	65	1.5	1.4	0.6
330.0	V	T520V337M004ASE009	132	10	9	3.7	3.4	1.5
330.0	V	T520V337M004ASE012	132	10	12	3.2	2.9	1.3
330.0	V	T520V337M004ASE025	132	10	25	2.2	2.0	0.9
330.0	V	T520V337M004ASE040	132	10	40	1.8	1.6	0.7
330.0	D	T520D337M004ASE009	132	10	9	4.1	3.7	1.6
330.0	D	T520D337M004ASE015	132	10	15	3.2	2.8	1.3
330.0	D	T520D337M004ASE040	132	10	40	1.9	1.7	0.8
330.0	D	T520D337M004ASE045	132	10	45	1.8	1.6	0.7
470.0	D	T520D477M004ASE010	188	10	10	3.9	3.5	1.5
470.0	D	T520D477M004ASE012	188	10	12	3.5	3.2	1.4
470.0	D	T520D477M004ASE015	188	10	15	3.2	2.8	1.3
470.0	D	T520D477M004ASE018	188	10	18	2.9	2.6	1.2
470.0	D	T520D477M004ASE025	188	10	25	2.4	2.2	1.0
470.0	D	T520D477M004ASE040	188	10	40	1.9	1.7	0.8
680.0	Y	T520Y687M004ATE010	272	10	10	4.0	3.6	1.6
680.0	Y	T520Y687M004ATE025	272	10	25	2.5	2.3	1.0
680.0	X	T520X687M004ASE010	272	10	10	4.1	3.7	1.6
680.0	X	T520X687M004ASE015	272	10	15	3.3	3.0	1.3
680.0	X	T520X687M004ASE035	272	10	35	2.2	2.0	0.9

POLYMER TANTALUM CHIP CAPACITORS T520 SERIES



T520 RATINGS & PART NUMBER REFERENCE

Capacitance μ F	Case Size	KEMET Part Number	DC Leakage μ A @ 25°C Max	DF% @ 25°C 120 Hz Max	ESR mW @ 25°C 100 kHz Max	Ripple Current mA rms @ 25°C, 100 kHz Max		
6/6.3 Volt Rating @ +85°C (5 Volt Rating at +105°C)								
15.0	T	T520T156M006ASE100	9.5	8	100	0.8	0.7	0.3
33.0	B	T520B336M006ASE040	21	8	40	1.5	1.3	0.6
33.0	B	T520B336M006ASE070	21	8	70	1.1	1.0	0.4
33.0	T	T520T336M006ATE070	21	8	70	1.0	0.9	0.4
47.0	B	T520B476M006ASE040	30	8	40	1.5	1.3	0.6
47.0	B	T520B476M006ASE070	30	8	70	1.1	1.0	0.4
68.0	B	T520B686M006ASE040	43	8	40	1.5	1.3	0.6
68.0	B	T520B686M006ASE070	43	8	70	1.1	1.0	0.4
100.0	B	T520B107M006ASE040	63	8	40	1.5	1.3	0.6
100.0	B	T520B107M006ASE070	63	8	70	1.1	1.0	0.4
100.0	V	T520V107M006ASE009	63	10	9	3.7	3.4	1.5
100.0	V	T520V107M006ASE012	63	10	12	3.2	2.9	1.3
150.0	V	T520V157M006ASE009	95	10	9	3.7	3.4	1.5
150.0	V	T520V157M006ASE012	95	10	12	3.2	2.9	1.3
150.0	V	T520V157M006ASE015	95	10	15	2.9	2.6	1.2
150.0	V	T520V157M006ASE025	95	10	25	2.2	2.0	0.9
150.0	V	T520V157M006ASE040	95	10	40	1.8	1.6	0.7
150.0	V	T520V157M006ASE045	95	10	45	1.7	1.5	0.7
150.0	D	T520D157M006ASE015	95	10	15	3.2	2.8	1.3
150.0	D	T520D157M006ASE025	95	10	25	2.4	2.2	1.0
150.0	D	T520D157M006ASE055	95	10	55	1.7	1.5	0.7
220.0	V	T520V227M006ASE009	139	10	9	3.7	3.4	1.5
220.0	V	T520V227M006ASE012	139	10	12	3.2	2.9	1.3
220.0	V	T520V227M006ASE015	139	10	15	2.9	2.6	1.2
220.0	V	T520V227M006ASE025	139	10	25	2.2	2.0	0.9
220.0	V	T520V227M006ASE040	139	10	40	1.8	1.6	0.7
220.0	D	T520D227M006ASE009	139	10	9	4.1	3.7	1.6
220.0	D	T520D227M006ASE015	139	10	15	3.2	2.8	1.3
220.0	D	T520D227M006ASE040	139	10	40	1.9	1.7	0.8
220.0	D	T520D227M006ASE050	139	10	50	1.7	1.6	0.7
330.0	V	T520V337M006ASE009	83	8	9	3.7	3.4	1.5
330.0	V	T520V337M006ASE025	208	10	25	2.2	2.0	0.9
330.0	V	T520V337M006ASE040	208	10	40	1.8	1.6	0.7
330.0	D	T520D337M006ASE010	208	10	10	3.9	3.5	1.5
330.0	D	T520D337M006ASE015	208	10	15	3.2	2.8	1.3
330.0	D	T520D337M006ASE025	208	10	25	2.4	2.2	1.0
330.0	D	T520D337M006ASE040	208	10	40	1.9	1.7	0.8
330.0	D	T520D337M006ASE045	208	10	45	1.8	1.6	0.7
330.0	Y	T520Y337M006ATE025	208	10	25	2.5	2.3	1.0
470.0	Y	T520Y477M006ATE010	297	10	10	4.0	3.6	1.6
470.0	Y	T520Y477M006ATE025	296	10	25	2.5	2.3	1.0
470.0	X	T520X477M006ASE010	297	10	10	4.1	3.7	1.6
470.0	X	T520X477M006ASE018	296	10	18	3.0	2.7	1.2
470.0	X	T520X477M006ASE035	296	10	35	2.2	2.0	0.9
470.0	X	T520X477M006ASE040	296	10	40	2.0	1.8	0.8
8 Volt Rating @ +85°C (6.4 Volt Rating at +105°C)								
33.0	B	T520B336M008ASE040	26	8	40	1.5	1.3	0.6
33.0	B	T520B336M008ASE070	27	8	70	1.1	1.0	0.4
150.0	D	T520D157M008ASE025	120	10	25	2.4	2.2	1.0
150.0	D	T520D157M008ASE040	120	10	40	1.9	1.7	0.8
150.0	D	T520D157M008ASE055	120	10	55	1.7	1.5	0.7
10 Volt Rating @ +85°C (8 Volt Rating at +105°C)								
33.0	B	T520B336M010ASE040	33	8	40	1.5	1.3	0.6
33.0	B	T520B336M010ASE070	33	8	70	1.1	1.0	0.4
68.0	V	T520V686M010ASE045	68	10	45	1.7	1.5	0.7
68.0	V	T520V686M010ASE060	68	10	60	1.4	1.3	0.6
100.0	V	T520V107M010ASE018	100	10	18	2.6	2.4	1.1
100.0	V	T520V107M010ASE025	100	10	25	2.2	2.0	0.9
100.0	V	T520V107M010ASE045	100	10	45	1.7	1.5	0.7
100.0	V	T520V107M010ASE050	100	10	50	1.6	1.4	0.6
100.0	D	T520D107M010ASE018	100	10	18	3.2	2.8	1.3
100.0	D	T520D107M010ASE055	100	10	55	1.7	1.5	0.7
100.0	D	T520D107M010ASE080	100	10	80	1.4	1.2	0.5
150.0	D	T520D157M010ASE025	150	10	25	2.4	2.2	1.0
150.0	D	T520D157M010ASE040	150	10	40	1.9	1.7	0.8
150.0	D	T520D157M010ASE055	150	10	55	1.7	1.5	0.7
220.0	D	T520D227M010ASE018	220	10	18	2.9	2.6	1.2
220.0	D	T520D227M010ASE025	220	10	25	2.4	2.2	1.0
220.0	D	T520D227M010ASE040	220	10	40	1.9	1.7	0.8
330.0	X	T520X337M010ASE010	330	10	10	4.1	3.7	1.6
330.0	X	T520X337M010ASE025	330	10	25	2.6	2.3	1.0
330.0	X	T520X337M010ASE040	330	10	40	2.0	1.8	0.8
16 Volt Rating @ +85°C (12.8 Volt Rating at +105°C)								
33.0	V	T520V336M016ASE060	53	10	60	1.4	1.3	0.6
47.0	V	T520V476M016ASE070	76	10	70	1.3	1.2	0.5
47.0	D	T520D476M016ASE070	75	10	70	1.5	1.3	0.6
25 Volt Rating @ +85°C (20 Volt Rating at +105°C)								
15.0	D	T520D156M025ASE060	38	10	60	1.6	1.4	0.6
15.0	D	T520D156M025ASE080	38	10	80	1.4	1.2	0.5

Polymer Tantalum Surface Mount

FEATURES

- Highest CV in Standard EIA Size
- Extremely Low ESR
- 125°C Max, Temperature Capability
- Polymer Cathode Technology
- High Frequency Capacitance Retention
- Non-Ignition Failure Mode
- Capacitance: 330 to 1500 μ F
- Voltage: 3V to 10V
- Molded Case (pick-and-place precision)
- 100% Accelerated Steady State Aging
- 100% Surge Current Testing
- Utilizes Multiple Tantalum Anode Technology
- Volumetric Efficiency
- Use Up to 80% of Rated Voltage (20% Derating)
- Self-Healing Mechanism
- True SMT Capability

OUTLINE DRAWINGS

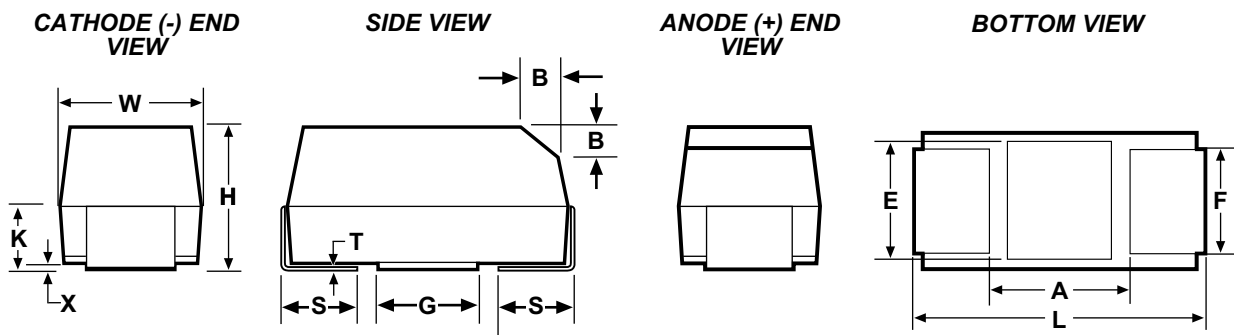

DIMENSIONS - MILLIMETERS (INCHES)

Case Size		L	W	H	K ± 0.20	F ± 0.1	S ± 0.3	X(Ref)	T(Ref)	A(Min)	G(ref)	E(ref)
KEMET	EIA											
D	7343-31	7.3 \pm 0.3	4.3 \pm 0.3	2.8 \pm 0.3	1.5	2.4	1.3	0.10 \pm 0.10	0.13	3.8	3.5	3.5
Y	7343-40	7.3 \pm 0.3	4.3 \pm 0.3	4.0 max	1.9	2.4	1.3	0.10 \pm 0.10	0.13	3.8	3.5	3.5
X	7343-43	7.3 \pm 0.3	4.3 \pm 0.3	4.0 \pm 0.3	2.3	2.4	1.3	0.10 \pm 0.10	0.13	3.8	3.5	3.5

T530 ORDERING INFORMATION

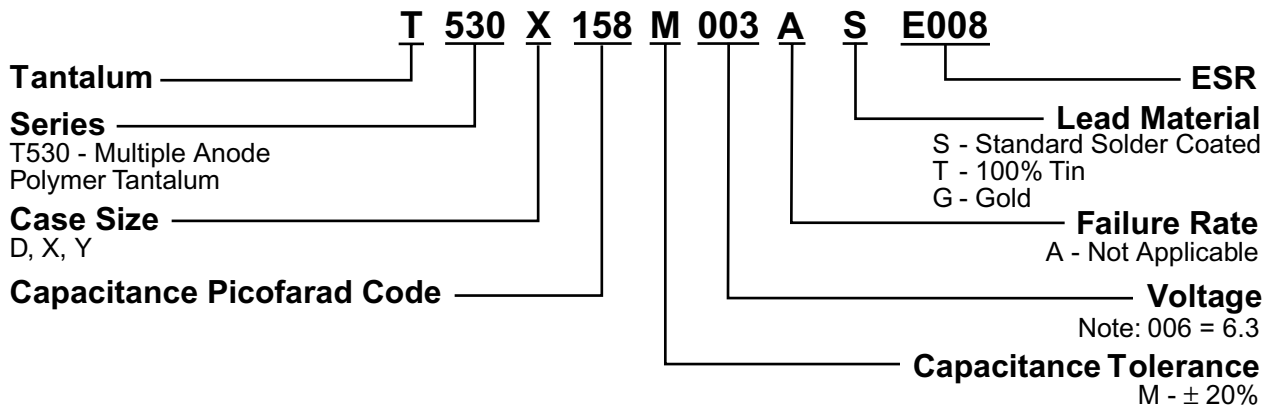

T530 RATINGS & PART NUMBER REFERENCE

Capacitance μ F	Case Size	KEMET Part Number	DCL V_R	DF % 120Hz	ESR mW @100 kHz 25°C Max	Ripple Current (Arms) @ 100 kHz			
						25°C	85°C	105°C	125°C
2.5 Volt Rating at 85°C (2 Volt Rating at 105°C)									
470.0	D/7343-31	T530D477M2R5ASE006	118 μ A	8.0	6	6.5	5.9	5.9	2.6
470.0	D/7343-31	T530D477M2R5ASE010	117 μ A	10.0	10	5.0	4.5	4.5	2.0
560.0	D/7343-31	T530D567M2R5ASE005	140 μ A	8.0	5	7.1	6.4	6.4	2.9
680.0	D/7343-31	T530D687M2R5ASE006	170 μ A	8.0	6	6.5	5.9	5.9	2.6
680.0	D/7343-31	T530D687M2R5ASE010	170 μ A	8.0	10	5.0	4.5	4.5	2.0
680.0	Y/7343-40	T530Y687M2R5ATE006	170 μ A	8.0	6	6.6	6.0	6.0	2.6
1000.0	X/7343-43	T530X108M2R5ASE006	250 μ A	8.0	6	6.7	6.0	6.0	2.7
1500.0	X/7343-43	T530X158M2R5ASE006	375 μ A	8.0	6	6.7	6.0	6.0	2.7
3 Volt Rating at 85°C (2.4 Volt Rating at 105°C)									
680.0	D/7343-31	T530D687M003ASE010	204 μ A	8.0	10	5.0	4.5	4.5	2.0
1000.0	X/7343-43	T530X108M003ASE010	300 μ A	8.0	10	5.2	4.7	4.7	2.1
1500.0	X/7343-43	T530X158M003ASE008	450 μ A	8.0	8	5.8	5.2	5.2	2.3
4 Volt Rating at 85°C (3.3 Volt Rating at 105°C)									
330.0	D/7343-31	T530D377M004ASE006	132 μ A	8.0	6	6.5	5.9	5.9	2.6
470.0	D/7343-31	T530D477M004ASE006	188 μ A	8.0	6	6.5	5.9	5.9	2.6
470.0	D/7343-31	T530D477M004ASE010	188 μ A	8.0	10	5.0	4.5	4.5	2.0
470.0	Y/7343-40	T530Y477M004ATE006	188 μ A	8.0	6	6.6	6.0	6.0	2.6
680.0	X/7343-43	T530X687M004ASE006	272 μ A	8.0	6	6.7	6.0	6.0	2.7
680.0	X/7343-43	T530X687M004ASE010	272 μ A	8.0	10	5.2	4.7	4.7	2.1
1000.0	X/7343-43	T530X108M004ASE006	400 μ A	8.0	6	6.7	6.0	6.0	2.7
6 Volt Rating at 85°C (5 Volt Rating at 105°C)									
220.0	D/7343-31	T530D227M006ASE006	139 μ A	8.0	6	6.5	5.9	5.9	2.6
330.0	D/7343-31	T530D337M006ASE006	208 μ A	8.0	6	6.5	5.9	5.9	2.6
330.0	D/7343-31	T530D337M006ASE010	208 μ A	8.0	10	5.0	4.5	4.5	2.0
330.0	Y/7343-40	T530Y337M006ATE006	208 μ A	8.0	6	6.6	6.0	6.0	2.6
470.0	X/7343-43	T530X477M006ASE006	297 μ A	8.0	6	6.7	6.0	6.0	2.7
470.0	X/7343-43	T530X477M006ASE010	296 μ A	8.0	10	5.2	4.7	4.7	2.1
10 Volt Rating at 85°C (8 Volt Rating at 105°C)									
150.0	D/7343/31	T530D157M010ASE006	150 μ A	8.0	6	6.5	5.9	5.9	2.6
220.0	D/7343/31	T530D227M010ASE006	220 μ A	8.0	6	6.5	5.9	5.9	2.6
220.0	D/7343/31	T530D227M010ASE010	220 μ A	8.0	10	5.0	4.5	4.5	2.0
220.0	Y/7343/40	T530Y227M010ATE006	220 μ A	8.0	6	6.6	6.0	6.0	2.6
330.0	X/7343-43	T530X337M010ASE006	330 μ A	8.0	6	6.7	6.0	6.0	2.7
330.0	X/7343-43	T530X337M010ASE010	330 μ A	8.0	10	5.2	4.7	4.7	2.1

Polymer Tantalum Surface Mount

COMPONENT MARKING

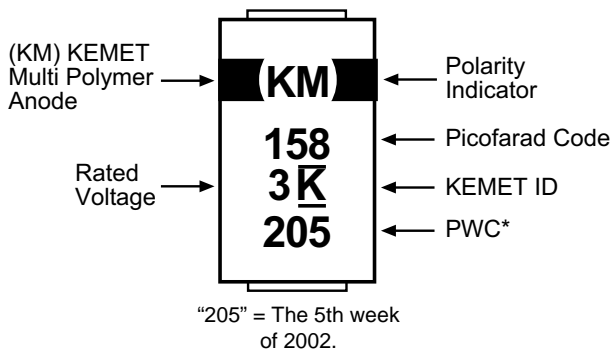

T530 SERIES CONSTRUCTION



T530X/T510E/T491E 1,000 μ F Capacitance vs. Frequency

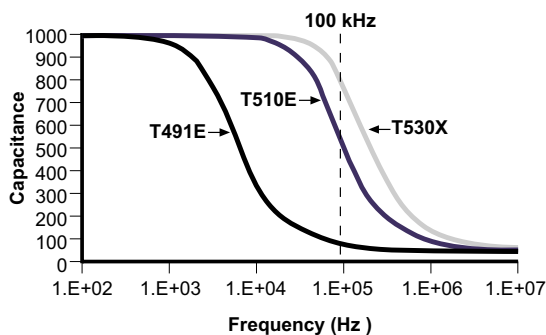

T530X/T510E/T491E 1,000 μ F Impedance & ESR vs. Frequency

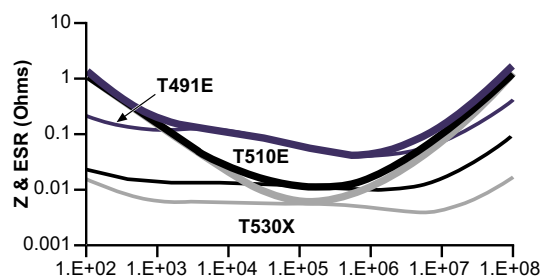

Tape & Reel Packaging

KEMET's Molded Tantalum Chip Capacitor families are packaged in 8 mm and 12 mm plastic tape on 7" and 13" reels, in accordance with EIA Standard 481-1: Taping of Surface Mount Components for Automatic Handling. This packaging system is compatible with all tape fed automatic pick and place systems.

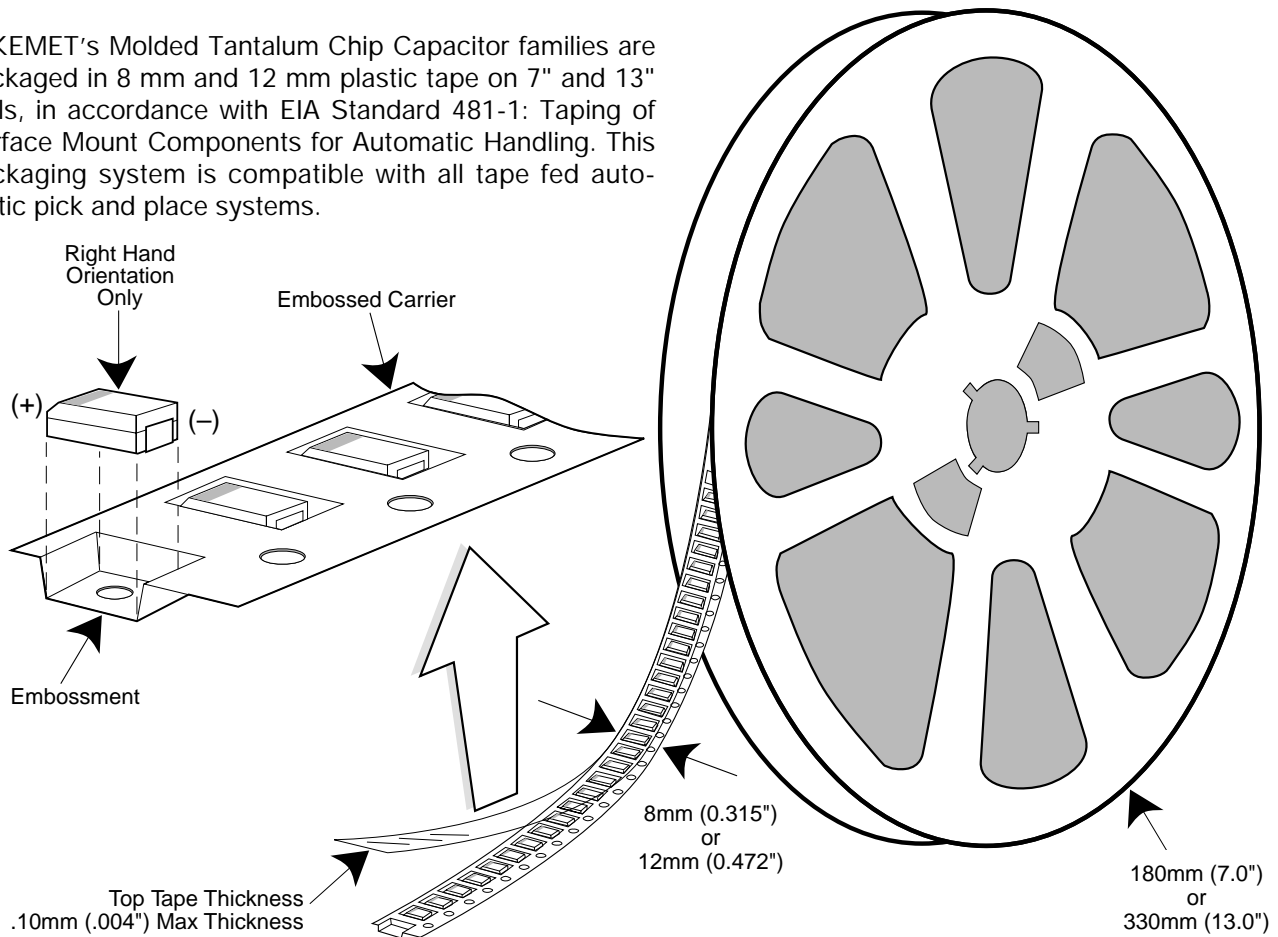

Labeling: Bar code labeling (standard or custom) shall be on the side of the reel opposite the sprocket holes. Refer to EIA-556.

QUANTITIES PACKAGED PER REEL

Case Code		Tape Width-mm	7" Reel*	13" Reel*
KEMET	EIA			
R	2012-12	8	2,500	10,000
S	3216-12	8	2,500	10,000
T	3528-12	8	2,500	10,000
U	6032-15	12	1,000	5,000
V	7343-20	12	1,000	3,000
A	3216-18	8	2,000	9,000
B	3528-21	8	2,000	8,000
C	6032-28	12	500	3,000
D	7343-31	12	500	2,500
X	7343-43	12	500	2,000
E	7260-38	12	500	2,000

* No c-spec required for 7" reel packaging. C-7280 required for 13" reel packaging.

Performance Notes

- Cover Tape Break Force:** 1.0 Kg Minimum.
- Cover Tape Peel Strength:** The total peel strength of the cover tape from the carrier tape shall be:

Tape Width	Peel Strength
8 mm	0.1 Newton to 1.0 Newton (10g to 100g)
12 mm	0.1 Newton to 1.3 Newton (10g to 130g)

The direction of the pull shall be opposite the direction of the carrier tape travel. The pull angle of the carrier tape shall be 165° to 180° from the plane of the carrier tape. During peeling, the carrier and/or cover tape shall be pulled at a velocity of 300 ±10 mm/minute.
- Reel Sizes:** Molded tantalum capacitors are available on either 180 mm (7") reels (standard) or 330 mm (13") reels (with C-7280). Note that 13" reels are preferred.
- Labeling:** Bar code labeling (standard or custom) shall be on the side of the reel opposite the sprocket holes. Refer to EIA-556.

Embossed Carrier Tape Configuration: Figure 1

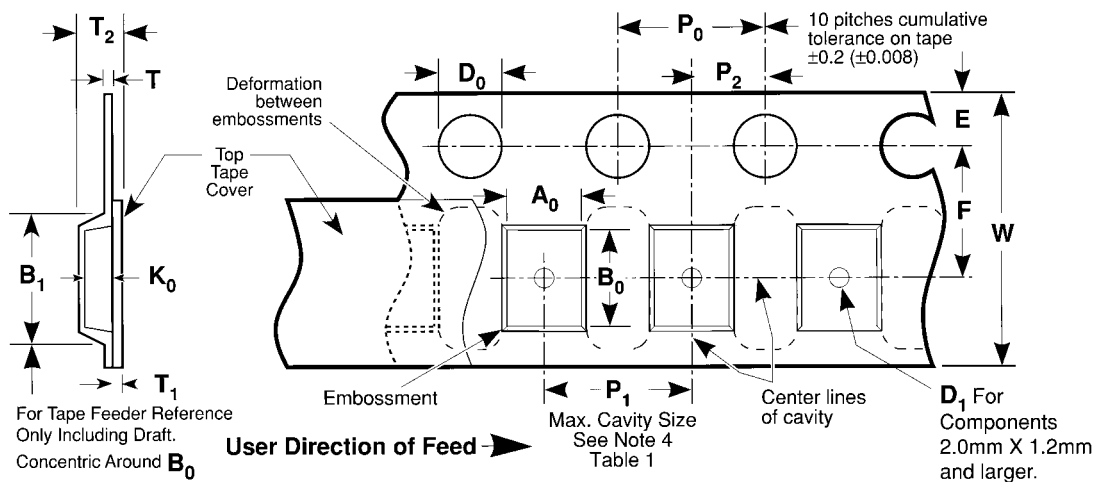

Table 1 — EMBOSSED TAPE DIMENSIONS (Metric will govern)

Constant Dimensions — Millimeters (Inches)									
Tape Size	D ₀	E	P ₀	P ₂	T Max	T ₁ Max			
8 mm and 12 mm	1.5 +0.10 -0.0 (0.059 +0.004, -0.0)	1.75 ±0.10 (0.069 ±0.004)	4.0 ±0.10 (0.157 ±0.004)	2.0 ±0.05 (0.079 ±0.002)	0.600 (0.024)	0.100 (0.004)			
Variable Dimensions — Millimeters (Inches)									
Tape Size	Pitch	B, Max. Note 1	D ₁ Min. Note 2	F	P ₁	R Min. Note 3	T ₂ Max	W	A ₀ B ₀ K ₀ Note 4
8 mm	Single (4 mm)	4.4 (0.173)	1.0 (0.039)	3.5 ±0.05 (0.138 ±0.002)	4.0 ±0.10 (0.157 ±0.004)	25.0 (0.984)	2.5 (0.098)	8.0 +0.3 -0.1 (0.315 +0.012, -0.004)	
12 mm	Double (8 mm)	8.2 (0.323)	1.5 (0.059)	5.5 ±0.05 (0.217 ±0.002)	8.0 ±0.10 (0.315 ±0.004)	30.0 (1.181)	4.6 (0.181)	12.0 ±0.30 (0.472 ±0.012)	

NOTES

- B1 dimension is a reference dimension for tape feeder clearance only.
- The embossment hole location shall be measured from the sprocket hole controlling the location of the embossment. Dimensions of embossment location and hole location shall be applied independent of each other.
- Tape with components shall pass around radius "R" without damage (see sketch A). The minimum trailer length (Fig. 2) may require additional length to provide R min. for 12 mm embossed tape for reels with hub diameters approaching N min. (Table 2)
- The cavity defined by A₀, B₀, and K₀ shall be configured to surround the part with sufficient clearance such that the chip does not protrude beyond the sealing plane of the cover tape, the chip can be removed from the cavity in a vertical direction without mechanical restriction, rotation of the chip is limited to 20 degrees maximum in all 3 planes, and lateral movement of the chip is restricted to 0.5 mm maximum in the pocket (not applicable to vertical clearance.)

Tantalum & Embossed Carrier Tape Configuration (cont.)

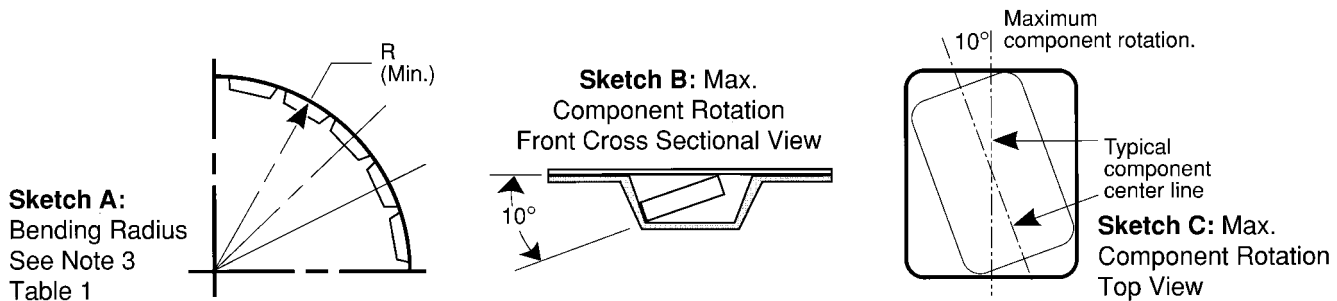

Sketch D: Tape Camber (Top View)

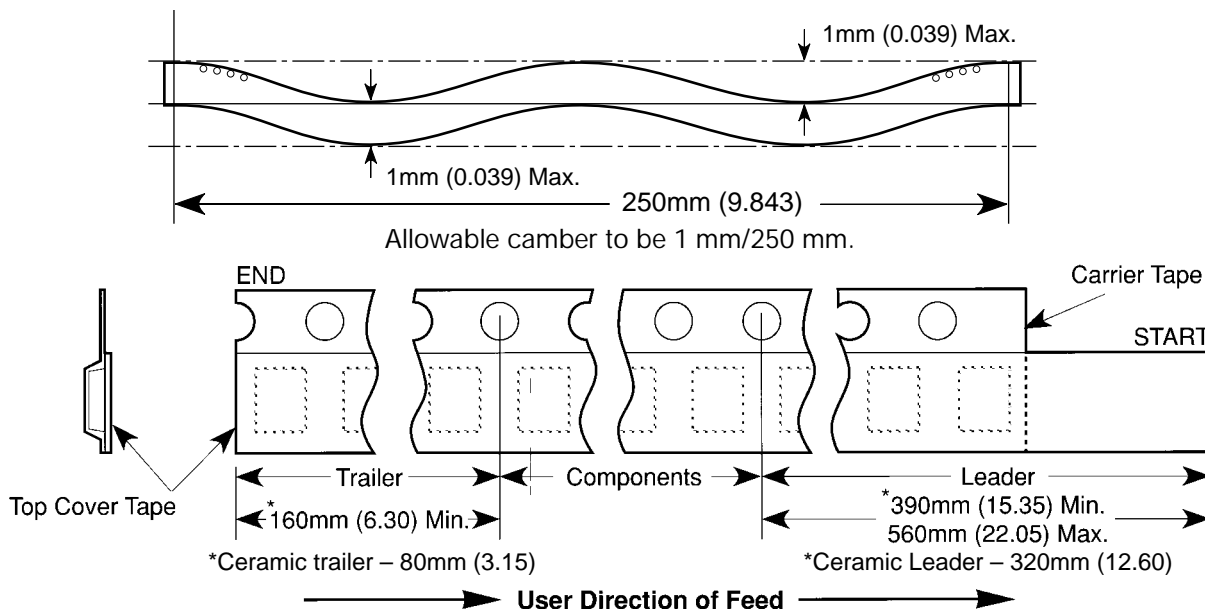

Figure 2: Tape Leader & Trailer Dimensions (Metric Dimensions Will Govern)

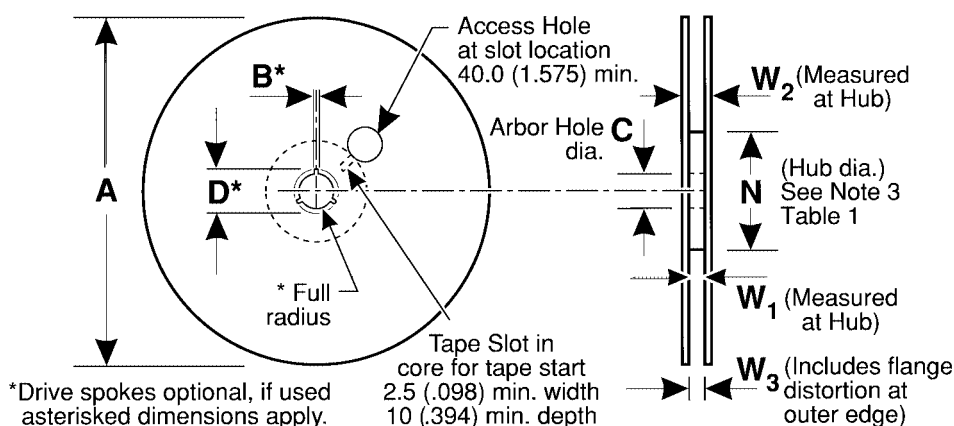

Figure 3: Reel Dimensions (Metric Dimensions will govern)

Table 2 – REEL DIMENSIONS (Metric will govern)

Tape Size	A Max	B* Min	C	D* Min	N Min	W ₁	W ₂ Max	W ₃
8 mm	330.0 (12.992)	1.5 (0.059)	13.0 ± 0.20 (0.512 ± 0.008)	20.2 (0.795)	50.0 (1.969) See Note 3	8.4 +1.5, -0.0 (0.331 +0.059, -0.0)	14.4 (0.567)	7.9 Min (0.311) 10.9 Max (0.429)
12 mm	330.0 (12.992)	1.5 (0.059)	13.0 ± 0.20 (0.512 ± 0.008)	20.2 (0.795)	Table 1	12.4 +2.0, -0.0 (0.488 +0.078, -0.0)	18.4 (0.724)	11.9 Min (0.469) 15.4 Max (0.606)

World Sales Headquarters
P.O. Box 5928 • Greenville, SC 29606 • www.kemet.com
Phone: (864) 963-6300 • Fax: (864) 963-6521

USA/Canada Locations

KEMET Electronics Corporation
26 Corporate Plaza, Suite 170
Newport Beach, CA 92660
Phone: 949-640-9320
Fax: 949-720-9807

KEMET Electronics Corporation
2350 Mission College Blvd., Suite 390
Santa Clara, CA 95054
Phone: 408-986-0424
Fax: 408-986-1442

KEMET Electronics Corporation
Schaumburg Corporate Center
Suite 350, 1515 Woodfield Road
Schaumburg, IL 60173
Phone: 847-517-1030
Fax: 847-517-1037

KEMET Electronics Corporation
444 Washington Street, Suite 510
Woburn, MA 01801
Phone: 781-933-1010
Fax: 781-376-0929

KEMET Electronics Corporation
8445 Freeport Parkway, Suite 320
Irving, TX 75063
Phone: 972-870-9530
Fax: 972-870-9537

KEMET Electronics Canada Ltd.
105-7145 West Credit Ave., Bldg. #2
Mississauga, L5N 6J7, ON
Canada
Phone: 905-542-7930
Fax: 905-542-7949

KEMET Electronics Canada Ltd.
65 boul. Brunswick, Suite 214
Dollard-des-Ormeaux, H9B-2N4 QC
Canada
Phone: 514-685-3773
Fax: 514-685-4077

Europe/Africa Locations

KEMET Electronics S.A.R.L.
2, Rue Nicolas Ledoux
Silic 254
Rungis Cedex 94568
France
Phone: 33-1-4512-5320
Fax: 33-1-4687-4087

KEMET Electronics GmbH
Hans-StieBberger-StraBe 2A
D85540 Haar/Munich
Germany
Phone: 49-89-456-4200
Fax: 49-89-460-4117

KEMET Electronics S.A.
1-3, Avenue de la Paix
P.O.B. 76
CH-1211 Geneva 20,
Switzerland
Phone: 41-22-715-0100
Fax: 41-22-715-0170

KEMET Electronics Ltd.
Waterfront House, 55/61 South St.
Bishop's Stortford
Hertfordshire, CM23 3AL
United Kingdom
Phone: 44-1279-75-7343
Fax: 44-1279-75-7188

Aviv Electronics Ltd.
Hayetzira St. No. 4
P.O. Box 2433
Ra'anana, 43100
Israel
Phone: 972-9-748-3232
Fax: 972-9-741-6510

Avnet South Africa
P.O. Box 13004
Belmont Office Park
14 Belmont Road
Rodebbasch
Capetown, South Africa 7705
Phone: 27-(0)21 689 4141
Fax: 27-(0)21 686 4709

Arrow Altech Distribution PTY LTD
P.O. Box 701
Isando, 1600
South Africa
Phone: 27-11-923-9699
Fax: 27-11-923-9720

Asia Locations

KEMET Electronics (Shanghai) Co., Ltd.
2/F, No. 7 Bldg., 330 Xlya Rd.
Waigaoqiao Free Trade Zone
Pudong, Shanghai 200137, China
Phone: 86-21-5046-0983
Fax: 86-21-5046-0981

KEMET Electronics Asia Ltd.
Rm 605, Citic Bldg.
No. 19 Jian Guo Men Wai Da Jie
Beijing, 100004, China
Phone: 86-10-8526-3628
Fax: 86-10-8526-3626

KEMET Electronics Asia Ltd.
4A Chuan Hing Industrial Bldg.
14 Wang Tai Road
Kowloon Bay, Hong Kong
Phone: 852-2305-1168
Fax: 852-2759-0345

KEMET Electronics Marketing PTE Ltd.
8-2-04, Sunny Point Kompleks, Jalan
Batu Uban, 11700 Penang
Penang, Malaysia
Phone: 60-4-6595200
Fax: 60-4-6595220

KEMET Electronics Marketing PTE Ltd.
101 Thomson Road, #23-03
United Square
Singapore, 307591, Singapore
Phone: 65-353-6636
Fax: 65-353-6656

KEMET Electronics Corporation
Taiwan Branch, 3-4F, No. 148, Section 4
Chung-Hsaio E. Rd.
Taipei, Taiwan ROC
Phone: 886-2-27528585
Fax: 886-2-27213129

WesTech Electronics & System Co. Ltd
302/12 Central Condominium
Ladproa Soil, Ladproa Road
Ladyao, Jatujak
Bangkok, Thailand 109000
Phone: 662-939-3482-6
Fax: 662-939-3491

Crusader Electronics Pty. Ltd.
Unit 3, 92 Bryant Street
Padstow, NSW 2211, Australia
Phone: 02-9792-3922
Fax: 02-9792-1446

Unicom International Corporation
702 Shinhwa Bldg., Mapo-Gu
Seoul, 121050, Korea
Phone: 82-2712-5821
Fax: 82-2712-5823